

e.Gò Nodo Step



→
anta nodo step
nodo step door

NODO
COLORE

design for your bathroom

e.Gò Nodo Step

→
| anta nodo step
| nodo step door

Anta con taglio a 45°

→
Door with 45° cut

/ e.Gò nodo step interpreta il bagno secondo uno stile moderno e attuale, grazie ad un'attenta progettazione studiata fin nei minimi dettagli. L'elemento chiave della collezione è l'anta con taglio a 45° che, abbinata ad una lavorazione STEP sui fianchi, definisce una presa maniglia funzionale ed esteticamente pulita. Un design rigoroso e originale, completato da finiture effetto legno e laccati lucidi o opachi.

/ e.Gò nodo step interprets the bathroom space in a current, modern key, thanks to a carefully structured design, studied down to the finest details. The feature piece in the collection is the door with a 45° cut which, when combined with the step pattern on the side panels, marks out a functional, aesthetically clean handle grip. The design is neat yet original, complete with wood-effect, and glossy and matt lacquered finishes.

e.Gò 56

L 170 P 51 cm
photo

Integrato

Top con lavabo integrato
in Unicolor stratificato HPL
Graffiato L 170 x P 51 x H 12 cm
Top with built-in wash basin in
Graffiato HPL Unicolor
W 170 x D 51 x H 12 cm



Base L. 170 / Base unit
finitura / finish
LACCATO GRIGIO PERLA
opaco con particolari
with details Nodo Tabacco

Specchiera / Mirror
Filo lucido L 75 x H 120
con faretto **Flipper** -
with **Flipper** spotlight





Il fascino grezzo del top forte spessore con lavabo integrato in Unicolor HPL Graffiato, dialoga con la base laccata Grigio Perla.

The raw appeal of the chunky top with a built-in washbasin in Graffiato HPL Unicolor sits well with the base unit lacquered in Grigio Perla.

Lavabo integrato rettangolare

Rectangular built-in washbasin

misure interno vasca / internal basin size

L 60 P 31 H 10 cm

finiture / finish
unicolor HPL Graffiato



Organizzare il bagno
con stile

**Il pensile, composto da vani a giorno
di diverse dimensioni, disegna una struttura
che scandisce e divide lo spazio.**

Organising your
bathroom in style

The wall unit, made up
of different sized open
compartments, marks out
a structure that defines
and divides the space.



e.Gò 57

L 195 P 51 cm
photo



Kratere basso
Lavabi Ø 45
in ceramica bianca
Washbasin Ø 45
in white ceramic



Base L. 195 / Base unit
finitura / finish
NODO LACCATO VERDE BOSCO
con particolari laccato Verde
Salvia - with details lacquered
in Verde Salvia

Top
Unicolor stratificato HPL
Graffiato L 195 x P 51 x Sp.1 cm

Specchiere / Mirrors
Tonda Ø 80 con luci led,
with LED lights





Kratere basso

Ø 45 cm



finiture / finish
ceramica bianca
white ceramic

misure interno vasca /
internal basin size
Ø 44 H 10 cm

Balance and reflection in the bathroom

Al centro della base si apre un elemento a giorno, che fa da perno al perfetto bilanciamento della composizione.

An open compartment in the centre of the base unit acts as the central pivot to perfectly balance this composition.

Equilibrio e specularità
nel bagno





E.GÒ 42

L 210 P 51 cm
photo

Integrato
Top con lavabo in teknoril
vasca rettangolare
L 140 x P 51 x H 12 cm
Top with built-in rectangular
wash basin in Teknoril

Base L. 140 / Base unit
finitura / finish
NODO TABACCO
con frontali - with frontal
nodo avorio

Specchiera / Mirror
Cristallo in Nodo Tabacco
L 45,9 x H 103,4 cm
con luci led - with LED lights

Forme per comporre
la parete

I moduli a giorno con la modanatura a gradino sono elementi autonomi da disporre liberamente in un gioco di finiture.

Shapes that make up the wall composition

The open modules with step-pattern moulding are independent units which can be arranged freely in a game of finishes.



e.Gò 39

L 136 P 51 cm
+ pensili / wall units
photo



Rio Small
Lavabo L. 60
in ceramica bianca
Washbasin W. 60
in white ceramic



Base L. 136 / Base unit
finitura / finish
NODO AVORIO

Top
Nodo Avorio sp.1.8 cm

Specchiere / Mirrors
Filo lucido L 85 x H 112.5 cm
con faretto **Regolo**
with spotlight **Regolo**





Il taglio a 45° dello spessore superiore crea una presa maniglia sicura e funzionale, abbinata alla fascia cromata della scocca.

The 45°- cut of the top thickness creates a secure and functional handle grip, teamed with the chrome section of the body.



Rio small

L 60 P 40 cm



finiture / finish
ceramica bianca
white ceramic

misure interno vasca /
internal basin size
L 58 P 38 H 12,5 cm



→
Trovare nuovi spazi per
la creatività

Il modulo a giorno può essere attrezzato con un divisore e un ripiano interno: un optional che aumenta la funzionalità.

The open module can be equipped with a partition and an internal shelf: an optional that enhances functionality.

E.GÒ 43

L 150 P 51 cm
photo

Mary

Lavabo incasso soprapiano
in mineralguss L 55 x P 43 cm
Built-in countertop
wash basin in Mineralguss

Base L. 150 / Base unit
finitura / finish
NODO BIANCO

Top
Legno invecchiato
Aged wooden
L 105 x P 51 x sp.8 cm

Specchiera / Mirror
Filo lucido L 140 x H 50 cm
faretto - with spotlight **Ufo**





La semplicità che non passa di moda
Simplicity that never dates

La forma del lavabo in appoggio
condivide l'essenzialità
geometrica del piano di
spessore e dei moduli sospesi.

The shape of the sit-on wash
basin shares the strikingly simple
geometric shape of the extra-thick
top and of the wall-mounted modules.

E.GÒ 58

L 170 P 51 cm
+ colonne / tall unit
photo

Giò

Lavabo incasso soprapiano
in ceramica bianca
Built-in countertop
wash basin in ceramic



Base L. 170 / Base unit
finitura / finish
STEP LACCATO NUVOLA OPACO
con particolari Brezza opaco
with matt Brezza details

Top
finitura / finish
Laccato Bianco opaco sp.1.8 cm

Specchiera / Mirror
Filo lucido L 50 x H 120 cm
con faretti - with spotlight **Spark**

Colonne **Step** / Tall unit
finitura / finish
Laccato nebbia opaco
Lacquered matt nebbia
L 25-35 x P 20.8 x H 165.5 cm



→
Giocare con il design
sulle pareti

**Gli elementi a giorno sospesi giocano
con linee aperte e chiuse, liberando lo spazio
e disegnando forme inedite.**

Playing with the
wall design

The floating open-
fronted units play
with open and closed
lines, freeing up space
and creating new and
original shapes.





Il forte spessore del top Unicolor Cesar Brown e la forma pulita del nuovo lavabo Susina in ceramica nera o bianca.

The extra thickness of the Cesar Brown Unicolor top and the clean-cut shape of the new black or white ceramic Susina wash basin.

E.GÒ 38

L 121 P 38 cm
+ pensili / + wall units
photo



Susina
ceramica nera L 55.2 x P 30 cm
wash basin in black ceramic

Base L. 60 / Base unit
finitura / finish
NODO TALCO

Top
Unicolore Cesar Brown
L 120 x P 38 x sp.6 cm

Specchiera / Mirror
L 60 x H 112,5 cm
filo Lucido con faretto **Klee**
with **Klee** spotlight





E.GÒ 37

L 106 P 51 cm
photo

Bob
Lavabo consolle in
mineralguss L. 105 cm
Console wash basin in
Mineralguss W. 105 cm

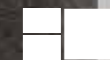

Base L. 105 / Base unit
finitura / finish
NODO TALCO

Specchiera / Mirror
Sghemba con faretto
Twilight - Sghemba with
Twilight spotlight





Una piccola curva fa incontrare il nuovo lavabo Bob in Mineralguss e il fianco della base: il design racconta l'eleganza.

A small curve joins the new Mineralguss Bob wash basin with the base unit side panel: design meets elegance.

Consolle Bob

L 105 cm

finiture / finish
in mineralguss

misure interno vasca /
internal basin size
L 60 P 35 H 12 cm

ak bathroom



La specchiera contenitore con faretto Matisse a tutta larghezza, una linea luminosa ripresa dai fianchi della base.

The Matisse full-width mirrored unit with spotlight, a luminous silhouette reflected by the side panels of the base unit.

→ Risaltare le linee con giochi di luce

E.GÒ 40

L 121 P 51 cm
+ sporgenza mensola / shelf overhang

Fusion

Lavabo consolle in mineralguss L. 120 cm - Console washbasin in Mineralguss W. 120 cm



Base L. 121 / Base unit
finitura / finish
NODO TABACCO

Specchiera / Mirror
Easy contenitore L. 85 x H 75 cm
con faretto **Matisse**
Easy storage mirror unit
with **Matisse** spotlight



e.Gò 36

L 105 P 51 cm
+ pensili / + wall units
photo

Bob
Lavabo consolle
in mineralguss L. 70 cm
Console wash basin in
Mineralguss W. 70 cm



Base L. 105 / Base unit
finitura / finish
NODO TABACCO

Specchiera / Mirror
Contenitore Easy
L 70 x H 75 cm cm luci led
e faretto Matisse
Easy storage mirror unit
with LED lights and
Matisse spotlight





Una struttura a giorno con spessore 3,5 cm disegna sulla parete una nuova funzionalità per i pensili, abbinando le finiture in un gioco di pieni e vuoti.

An open structure with a thickness of 3.5 cm designs a new functionality on the wall for wall units, teaming the various finishes in a game of blocks and voids.

→
Progettare la parete
con i pensili

Luci led

Profilo luci led per base
H. 53 cm in plexiglass
4.5W - classe A+ - Lumen 338
Kelvin 4000

LED profile for base unit
H. 53 cm in Plexiglas
4.5W - class A+ - 338 Lumen
4000 Kelvin



e.Gò 59

L 128 P 51 cm
+ pensili / + wall units
photo

Integrato

Top con lavabo integrato
in teknoril sp.1.2 cm
Top with built-in wash basin
in Teknoril, th. 1.2 cm

Base L. 120 / Base unit
finitura / finish
STEP LACCATO
GERMOGLIO OPACO
con particolari - with details in
matt Sky opaco e Nodo Bianco

Specchiera / Mirror
Filo lucido L 60 x H 112.5 cm
con faretto - with spotlight Aalto



Il top è un'unica superficie bianca con lavabo integrato e una fessura come porta asciugamani. Minimale e ingegnosa.

The top consists of a single white surface with a built-in washbasin and a slot that serves as a towel rail. Minimal, ingenious.

Porta asciugamani

Sporgenza della base + 8 cm

Towel rail
Base unit protrusion + 8 cm

finiture / finish
teknoril

misura fessura /
slot size
L 3 P 41 cm



→
Creare armonia tra
colori e finiture

La texture naturale delle venature e le tonalità fresche dei laccati opachi creano un'atmosfera rilassante e sospesa.

Creating harmony
between colours
and finishes

The natural texture of
the wood grain and the
fresh shades of the
matt lacquers create a
relaxed, floaty feel.



Finishes Nodo

e.Gò 41

L 96 P 51 cm
+ pensili / + wall units
photo



Nespola 70

Lavabo in
ceramica bianca
Wash basin in
white ceramic



Base L 95 / Base unit
finitura / finish
NODO BIANCO

Top
finitura / finish
Nodo Bianco sp.1.8 cm

Specchiera / Mirror
Ba-Bà con faretto
with spotlight Ridley





Nespola 70

L 70 P 35 H 15 cm



finiture / finish
ceramica bianca
white ceramic

misure interno vasca /
internal basin size
L 68 P 33 H 12 cm

Sleek simplicity, all in white

L'ampio lavabo in appoggio,
il volume capiente della base
e i pratici vani a giorno: una
composizione dalla luce speciale.

The generous sit-on wash basin,
the capacious volume of the base unit
and the practical open compartments:
a composition with a special light.

→
Esprimere essenzialità
con il total white



Disegnare l'arredo con
linee impeccabili

Volumi rigorosi e precisi, dai contorni ben delineati.
La finitura in laccato Nebbia è illuminata dalla
fascia cromata della scocca.

Designing furniture with
flawless lines

Structured, precise shapes
with well-defined contours.
A chrome strip along
the casing lights up the
lacquered Nebbia finish.



E.GÒ 32b

L 95 P 51 cm
photo

Drop
Lavabo L. 95
in ceramica bianca
Washbasin W. 95
in white ceramic



Base L. 95 / Base unit
finitura / finish
STEP LACCATO NEBBIA

Specchiera / Mirror
Filo lucido L 70 x H 75 cm
con faretto, with spotlight Filo



La specchiera diventa il tocco di design che completa e definisce lo stile.

A special light to add a personal touch to the textured grain.

E.GÒ 34

L 105 P 51 cm
+ sporgenza mensola /
+ shelf overhang

Integrato

Top con lavabo integrato
ovale in teknorit
Top with oval built-in wash
basin in Teknorit

Base L. 105 / Base unit
finitura / finish
NODO TABACCO

Specchiera / Mirror
Orion con luce led
with LED light

E.GÒ 31

L 85 P 51 cm
+ pensili / + wall units
photo

Roxy

Lavabo consolle
in mineralguss
Console wash basin
in Mineralguss

Base L. 85 / Base unit
finitura / finish
NODO AVORIO

Specchiera / Mirror
Contenitore **Cabrio**
L 85 x H 75 cm con faretto
Spark - Cabrio storage
mirror unit with **Spark**
spotlight



E.GÒ 30

L 120 P 51 cm
+ pensili / + wall units
photo

Fusion
Lavabo console in
mineralguss - Console
washbasin in Mineralguss

Base L. 95 / Base unit
finitura / finish
NODO TALCO

Specchiera / Mirror
Hendrick's con luci led
with LED lights





→
Portare praticità con il lavabo
console in ceramica

E.GÒ 60

L 50 P 38 cm
photo

Pampa
Lavabo console in ceramica
Ceramic console wash basin



Base L. 50 / Base unit
finiture / finish
STEP LACCATO TAUPE
opaco - matt

Specchiera / Mirror
Filo lucido L 50 x H 95 cm
con faretto - with
spotlight **Filo**



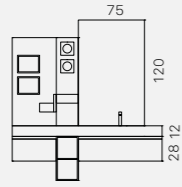

E.GÒ nodo step 56 (page 4-5)
L 170 x P 51 cm

Integrato
Top con Lavabo in Unicolor stratificato HPL Graffiato L 170 x P 51 x H 12 cm

Base L. 170
Finitura **Laccato grigio perla opaco** con particolari Nodo Tabacco

Specchiera
Filo lucido L 75 x H 120 con faretto Flipper

Built-in
Top with wash basin in Graffiato HPL Unicolor W 170 x D 51 x H 12 cm

Base unit W. 170
Finish **lacquered in matt Grigio Perla** with Nodo Tabacco details

Mirror
Filo Lucido mirror W 75 x H 120 with Flipper spotlight

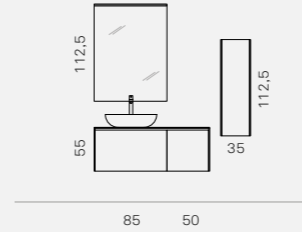

E.GÒ nodo step 39 (page 18-19)
L 136 x P 51 cm + pensili / wall units

Rio Small
Lavabo L. 60 cm in ceramica bianca

Base L. 136
Finitura **Nodo avorio**

Top
Nodo Aporio sp.1.8 cm

Specchiera
Filo lucido L 85 x H 112.5 cm con faretto Regolo

Rio Small
Washbasin W. 60 cm in white ceramic

Base unit W. 136
Finish **Nodo avorio**

Top
Nodo Aporio th.1.8 cm

Mirror
Filo Lucido W 85 x H 112.5 cm with Regolo spotlight

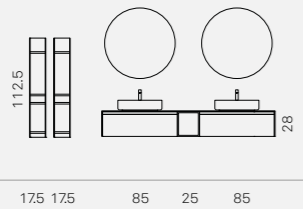

E.GÒ nodo step 57 (page 10-11)
L 195 x P 51 cm

Kratero basso
Lavabi Ø 45 cm in ceramica bianca

Base L. 195
Finitura **Nodo laccato verde bosco** con particolari laccato Verde Salvia

Top Unicolor
stratificato HPL Graffiato L 195 x P 51 x Sp.1 cm

Specchiera
Tonda Ø 80 cm con luci led

Kratero basso
Washbasin Ø 45 cm in white ceramic

Base unit W. 195
Finish **Nodo lacquered in Verde Bosco** with details lacquered in Verde Salvia

Top Unicolor
stratificato HPL Graffiato W 195 x D 51 x th.1 cm

Mirror
Tonda Ø 80 cm with LED lights

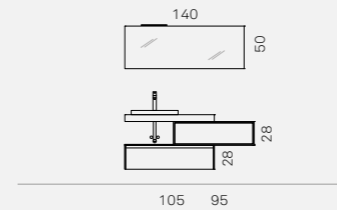

E.GÒ nodo step 43 (page 22-23)
L 150 x P 51 cm

Mary
Lavabo incasso soprapiano in mineralguss L 55 x P 43 cm

Base L. 150
Finitura **Nodo bianco**

Top
Legno invecchiato L 105 x P 51 x sp.8 cm

Specchiera
Filo lucido L 140 x H 50 cm faretto Ufo

Mary
Washbasin Built-in countertop in Mineralguss W 55 D 43 cm

Base unit W. 150
Finish **Nodo bianco**

Top
Aged wooden W 105 x D 51 x th.8 cm

Mirror
Filo lucido W 140 x H 50 cm with spotlight Ufo

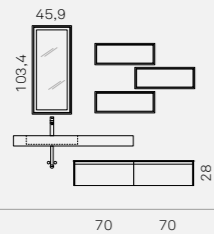

E.GÒ nodo step 42 (page 14-15)
L 210 x P 51 cm

Integrato
Top con lavabo in teknoril vasca rettangolare L 140 x P 51 x H 12 cm

Base L. 140
Finitura **Nodo tabacco** con frontali nodo avorio

Specchiera
Cla cla in Nodo Tabacco L 45.9 x H 103.4 cm con luci led

Integrated
Top with Washbasins With built-in rectangular in Teknoril W 140 x D 51 x H 12 cm

Base unit W. 140
Finish **Nodo tabacco** with frontal nodo avorio

Mirror
Cla Cla in Nodo Tabacco W 45.9 x H 103.4 cm with LED lights

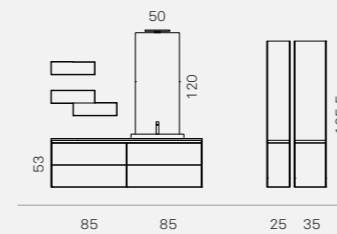

E.GÒ nodo step 58 (page 26-27)
L 170 x P 51 cm + colonne / tall unit

Giò
Lavabo incasso soprapiano in ceramica bianca

Base L. 170
Finitura **step laccato nuvola opaco** con particolari Brezza opaco

Top
Laccato Bianco opaco sp.1.8 cm

Specchiera
Filo lucido L 50 x H 120 cm con faretto Spark

Colonne Step
Laccato nebbia opaco

Giò
Washbasin Built-in countertop in ceramic

Base unit W. 170
Finish **Step base unit lacquered in matt Nuvola** with matt Brezza details

Top
Lacquered matt Bianco th. 1.8 cm

Mirror
Filo lucido W 50 x H 120 cm with spotlight Spark

Tall unit Step
Lacquered matt nebbia

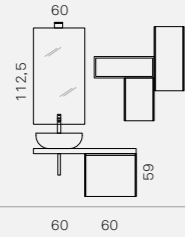

E.GÒ nodo step 38 (page 30-31)
L 121 x P 38 cm + pensili / + wall units

Susina
Lavabo in ceramica nera
L 55.2 x P 30 cm

Susina
Washbasins in black ceramic
W 55.2 x D 30 cm

Base L. 60
Finitura **Nodo talco**

Base unit W. 60
Finish **Nodo talco**

Top
Unicolore Cesar Brown
L 120 x P 38 x sp.6 cm

Top
Unicolore Cesar Brown
L 120 x P 38 x sp.6 cm

Specchiera
L 60 x H 112,5 cm
filo Lucido con faretto Klee

Mirror
W 60 x H 112,5 cm
filo Lucido with Klee spotlight

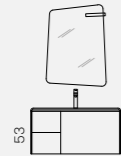

E.GÒ nodo step 37 (page 32-33)
L 106 x P 51 cm

Bob
Lavabo consolle in mineralguss L 105 cm

Bob
Washbasins Console in Mineralguss W 105 cm

Base L. 105
Finitura **Nodo talco**

Base unit W. 105
Finish **Nodo talco**

Specchiera
Sghemba con faretto Twilight

Mirror
Sghemba with Twilight spotlight

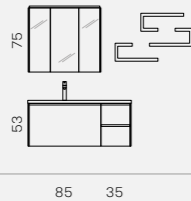

E.GÒ nodo step 40 (page 36-37)
L 121 x P 51 cm + sporgenza mensola / shelf overhang

Fusion
Lavabo consolle in mineralguss L 120 cm

Fusion
Wash basin console in Mineralguss W 120 cm

Base L. 121
Finitura **Nodo Tabacco**

Base unit W. 121
Finish **Nodo Tabacco**

Specchiera
Easy contenitore L 85 x H 75 cm con faretto Matisse

Mirror
Easy storage unit W 85 x H 75 cm with Matisse spotlight

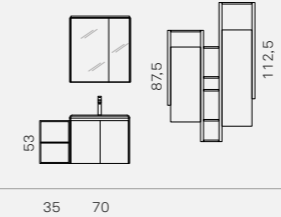

E.GÒ nodo step 36 (page 38-39)
L 105 x P 51 cm + pensili / wall units

Bob
Lavabo consolle in mineralguss L 70 cm

Bob
Washbasin console in Mineralguss W. 70 cm

Base L. 105
Finitura **Nodo tabacco**

Base unit W. 105
Finish **Nodo tabacco**

Specchiera
Contenitore Easy L 70 x H 75 cm cm luci led e faretto Matisse

Mirror
Easy storage mirror unit with LED lights and Matisse spotlight

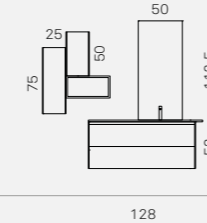

E.GÒ nodo step 59 (page 42-43)
L 128 x P 51 cm + pensili / wall units

Integrato
Top con lavabo integrato in teknoril sp.1.2 cm

Integrated
Top with Washbasins built-in in Teknoril, th. 1.2 cm

Base L. 120
Finitura **step laccato germoglio opaco** con particolari Sky opaco e Nodo Bianco

Base unit W. 120
Finish **Step lacquered in matt Germoglio** with details in matt Sky and Nodo Bianco

Specchiera
Filo lucido L 60 x H 112.5 cm con faretto Aalto

Mirror
Filo Lucido W 60 x H 112.5 cm with Aalto spotlight

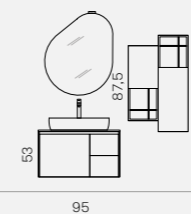

E.GÒ nodo step 41 (page 48-49)
L 96 x P 51 cm + pensili / wall units

Nespola 70
Lavabo in ceramica bianca

Nespola 70
Washbasin in white ceramic

Base L. 95
Finitura **Nodo bianco**

Base unit W. 95
Finish **Nodo bianco**

Top
Nodo Bianco sp.1.8 cm

Top
Nodo Bianco th.1.8 cm

Specchiera
Ba-Bà con faretto Ridley

Mirror
Ba-Bà with Ridley spotlight

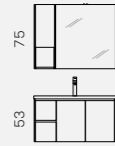

95

E.GÒ nodo step 32b (page 52-53)
L 95 x P 51 cm

Drop
Lavabo L. 95
in ceramica bianca

Drop
Washbasin W. 95
in white ceramic

Base L. 95
Finitura **step laccato nebbia**

Base unit W. 95
Finish **step laccato nebbia**

Specchiera
Filo lucido L 70 x H 75 cm
con faretto Filo

Mirror
Filo lucido W 70 x H 75 cm
with spotlight Filo

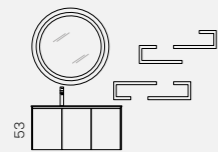

105

E.GÒ nodo step 34 (page 54)
L 105 x P 51 cm + sporgenza mensola /shelf overhang

Integrato
Top con lavabo integrato
ovale in teknorit

Integrato
Top with washbasin
oval built-in Teknorit

Base L. 105
Finitura **Nodo tabacco**

Base unit W. 105
Finish **Nodo tabacco**

Specchiera
Orion con luce led

Mirror
Orion with LED light

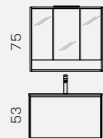

85

E.GÒ nodo step 31 (page 55)
L 85 x P 51 cm + pensili / + wall units

Roxy
Lavabo consolle
in mineralguss

Roxy
Washbasins console
in Mineralguss

Base L. 85
Finitura **Nodo avorio**

Base unit W. 85
Finish **Nodo avorio**

Specchiera
Contenitore Cabrio
L 85 x H 75 cm
con faretto Spark

Mirror
Cabrio storage
W 85 x H 75 cm
unit with Spark spotlight

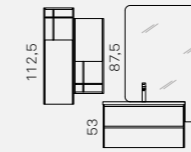

35 35 95

E.GÒ nodo step 30 (page 56-57)
L 120 x P 51 cm + pensili / + wall units

Fusion
Lavabo consolle in
mineralguss

Fusion
Washbasins consolle
in Mineralguss

Base L. 95
Finitura **Nodo talco**

Base unit W. 95
Finish **Nodo talco**

Specchiera
Hendrick's con luci led

Mirror
Hendrick's with LED lights

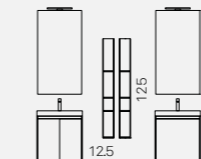

50 50

E.GÒ nodo step 60 (page 58-59)
L 50 x P 38 cm

Pampa
Lavabo
consolle in ceramica

Pampa
Washbasins
ceramic console

Base L. 50
Finitura **step laccato**
taupe opaco

Base unit W. 50
Finish **step lacquered**
taupe matt

Specchiera
Filo lucido L 60 x H 112.5 cm
con faretto Aalto

Mirror
Filo lucido W 50 x H 95 cm
with spotlight Aalto

Nodo



Bianco



Avorio



Talco



Tabacco

Laccato opaco e lucido o nodo laccato opaco

Matte and gloss lacquered or matt lacquered Nodo



Inox Taupe Nero Grigio fumo di Londra Cenere Nebbia Grigio Perla Brezza



Bianco New Pergamon Ecrù Juta Canapa Terranova Brown Cacao



Terra Visone Verde bosco Verde oliva Verde Twiggì Verde salvia The verde Germoglio



Fiordaliso Vaniglia Giallo Polline Arancio Mattone Rosso Fuoco Bordeaux Rosso India



Blu Night Blu Marin Navy Petrolio Cascata Cielo Acquamarina Sky



Nuvola Lavanda Glicine Rosa confetto Lilla light Bocciole Geranio Amarena



Lampone



Platino*
Laccato opaco / Matt lacquer

Design e coordinamento: Arcom
Progetto Grafico: Lokomotiv
Foto: Indoor
Art direction photo and styling: Rossi & Co.
Fotolito: Luce
Stampa: OGM SpA
Stampato: Febbraio 2018



By ARCOM srl

33070 Tamai di Brugnera (PN) Italy

Viale Europa 4

T. +39.0434.613619 / 1573020

F. +39.0434.608137

info@arcombagno.com

www.arcombagno.com



e-mail: gruppoatma@gruppoatma.it

<http://www.gruppoatma.it>

e.Gò

→
anta con maniglia a gola
grip-recessed handle

ROVERE
LARICE
FRASSINO
YOSEMITE
NODO
ARES
OLMO
SHERWOOD
COLORE



ak
bathstyle

design for your bathroom

e.Gò

→
| anta con maniglia a gola
| grip-recessed handle



Anta con maniglia a gola

→
Grip-recessed handle

/ La maniglia a gola è la soluzione perfetta per chi cerca nel design il massimo della purezza. Per questo è l'elemento fondamentale di e.Gò: una collezione dallo spirito contemporaneo con accenni naturali. Una combinazione sapiente di forme essenziali e finiture materiche, di volumi rigorosi e colori rubati alla natura. Un arredobagno con personalità e al contempo delicato.

/ A groove handle is the perfect solution for those who seek purity in design. This is why it is the central feature of the e.Gò collection, which has a modern spirit with natural accents. This informed combination consists of simple shapes, textured finishes, defined volumes and colours taken from nature itself. This bathroom furniture has personality but, at the same time, is delicate.

E.GÒ 61

L 170 P 51 cm
photo

Kratere
Lavabo "tutto fuori"
in ceramica bianca
Countertop white
ceramic washbasin

Base L. 170 / Base unit
finitura / finish
FRASSINO BIANCO

Top
finitura / finish
Bianco opaco sp. 7 cm

Specchiera / Mirror
Filo lucido L 50 x H 120
con faretto **Aalto**
with **Aalto** spotlight





Kratere basso

Ø 45 cm



finiture / finish
ceramica bianca
white ceramic

misure interno vasca /
internal basin size
Ø 44 H 10 cm

Finding the balance between tone and form

Verde il pensile laccato,
bianche le venature della base:
le finiture giocano con sottili
richiami alla natura.

Green for the lacquered wall
unit, white for the grain on the
base unit: the finishes play with
subtle references to nature.

→ Cercare un equilibrio di
tonalità e forme



E.GÒ 62

L 155 P 51 cm
photo

Integrato

Top con lavabo integrato
in Unicolor stratificato HPL Cesar-
Brown L 155 x P 51 x sp. 1 cm
Top with integrated
washbasin in Cesar-Brown HPL
composite Unicolor



Base L. 155 / Base unit
finitura / finish
YOSEMITE CHIARO
particolari laccati Platino
details in lacquered Platino

Specchiera / Mirror
Bà-Bà





La maniglia a gola è l'elemento chiave della collezione. I dettagli Platino creano un interessante contrasto con la naturalezza del top e della base.

The groove handle is the key element in this collection. The details in Platino create an interesting contrast with the natural top and base unit.

→ Valorizzare la gola con le giuste finiture

Top Unicolor

stratificato HPL sp.1 cm

finiture / finish
Cesar Brown

misure interno vasca integrata /
internal built-in basin size
L 60 P 31 H 10 cm



→ Far risaltare le forme
con i vani a giorno

**Gli elementi a giorno interrompono il rigore
dei volumi. I bagliori metallici si sposano
perfettamente con le venature.**

Bringing out the form
with open compartments

Open-fronted units break
up the structured shapes.
Metallic glimmers sit
perfectly alongside the
wood grain.



E.GÒ 54

L 155 P 51 cm
photo

Dandy

Lavabo incasso
in ceramica bianca
Built-in white ceramic
washbasin



Base L. 155 / Base unit
finitura / finish
ARES 50 SOLARE
particolari laccato Navy opaco
details in matt Navy lacquer

Top
finitura / finish
Unicolor Graffiato sp.6 cm

Specchiera / Mirror
Filo lucido L 105 x H 112,5 cm
con faretto Fedra -
with Fedra spotlight





Assicurare vivibilità senza rinunciare allo stile

Liveable, and stylish

La gola è adatta a chi cerca una soluzione pratica e discreta. Garantisce la sicurezza della presa maniglia e mantiene i frontali sgombri e puliti.

The groove grip suits those looking for a practical yet low-key solution. It guarantees a secure grip, and keeps the unit fronts clean and uncluttered.



E.GÒ 66

L 230 P 51 cm
photo

Dandy

Lavabo incasso soprapiano
in ceramica bianca
Built-in countertop
washbasin in white ceramic



Base L. 145 / Base unit
finitura / finish
LARICE BIANCO
particolari laccati cascata
opaco details in matt
Cascata lacquer

Top
finitura / finish
Larice bianco sp.10 cm

Specchiera / Mirror
con Ala e specchio
ingranditore - with Ala
and magnifying mirror
L 165 x H 50 cm





Base, top, pensile e specchiera si dispongono in modo omogeneo, formando un'aggregazione di volumi rigorosi ma leggeri, che tracciano linee marcatamente orizzontali.

The base unit, top, wall unit and mirror are arranged evenly, creating an airy yet structured collection of shapes and forms, that mark out distinctly horizontal lines.

Lampade Roller

H 40 Ø 2,5 cm

finiture / finish
cromo con tubolare
in vetro bianco
cromo with tube
in white glass

Potenza 2W - Classe A+
Lumen 1000 - Kelvin 4000

E.GÒ 67

L 165/170 P 51/38 cm
photo

Dandy

Lavabo incasso
in ceramica bianca
Built-in washbasin
in white ceramic



Base / Base unit
finitura / finish
LACCATA FIORDALISO OPACO
particolari laccati Petrolio
opaco - details in matt
Petrolio lacquer

Top
finitura / finish
Marmo Bianco Olimpo sp.2 cm

Specchiera / Mirror
Tonda Ø 80 cm
con luci led - with led lights
Ø 40 cm



Dandy

L 56 P 43 H 4 cm

finiture / finish
ceramica bianca
white ceramic

misure interno vasca /
internal basin size
L 53 P 28 H 9 cm

Rediscover the beauty of simplicity

La chiarezza e la semplicità del design si sposano con le finiture dai toni freschi e rilassanti.

A clear and simple design matches the fresh and relaxing finishes.

→
Riscoprire la bellezza
della semplicità





Cestoni da prendere per la gola
Large drawers to grab by the groove

I cestoni, ampi e capienti, si aprono con facilità grazie alla maniglia a gola, che garantisce una presa salda. Per un bagno bello da vivere oltre che da vedere.

These large, spacious drawers open with ease, thanks to the groove handle which provides a secure grip. This bathroom is easy on the eye and easy to live with.



E.GÒ 53

L 155 P 51 cm
+ magnetica
photo



Prugna
Lavabo "tutto fuori"
in ceramica bianca
Countertop washbasin
in white ceramic



Base L. 155 / Base unit
finitura / finish
OLMO JEREZ CANAPA

Top
finitura / finish
Unicolor Cesar-Brown sp.6 cm

Specchiera / Mirror
Filo lucido L 120 x H 112.5
con faretto - with spotlight
Regolo





→
Comporre un ambiente
rilassante

**Un bagno a misura di relax
Creating a relaxing space**

Le tonalità scure si accostano all'essenza. Lo spessore dei volumi varia e gli elementi si collocano in uno spazio dall'atmosfera zen.

The dark shades sit alongside the wood finish. The depth of the different shapes varies and the units are arranged in the space to create a Zen feel.



E.GÒ 65

L 170 P 51 cm
photo

Giò
Lavabo incasso
in ceramica bianca
Built-in washbasin
in white ceramic

Base L. 170 / Base unit
finitura / finish
ROVERE ARLINGTON

Top
finitura / finish
Rovere Arlington sp.10 cm

Specchiera / Mirror
Con Ala e specchio ingranditore
with Ala and magnifying mirror
L 165 x H 50 cm



La specchiera si adatta alle necessità di chi la usa. Il lavabo a incasso rispetta la leggerezza del top e della base in sospensione.

The mirror unit adapts to the needs of the user. The built-in washbasin continues the weightless feel of the top and floating base unit.

→
Piegare la specchiera
alle proprie esigenze

Specchiera con Ala

L 165 H 50 cm

Ala destra orientabile con specchio ingranditore

Adjustable right wing with magnifying mirror

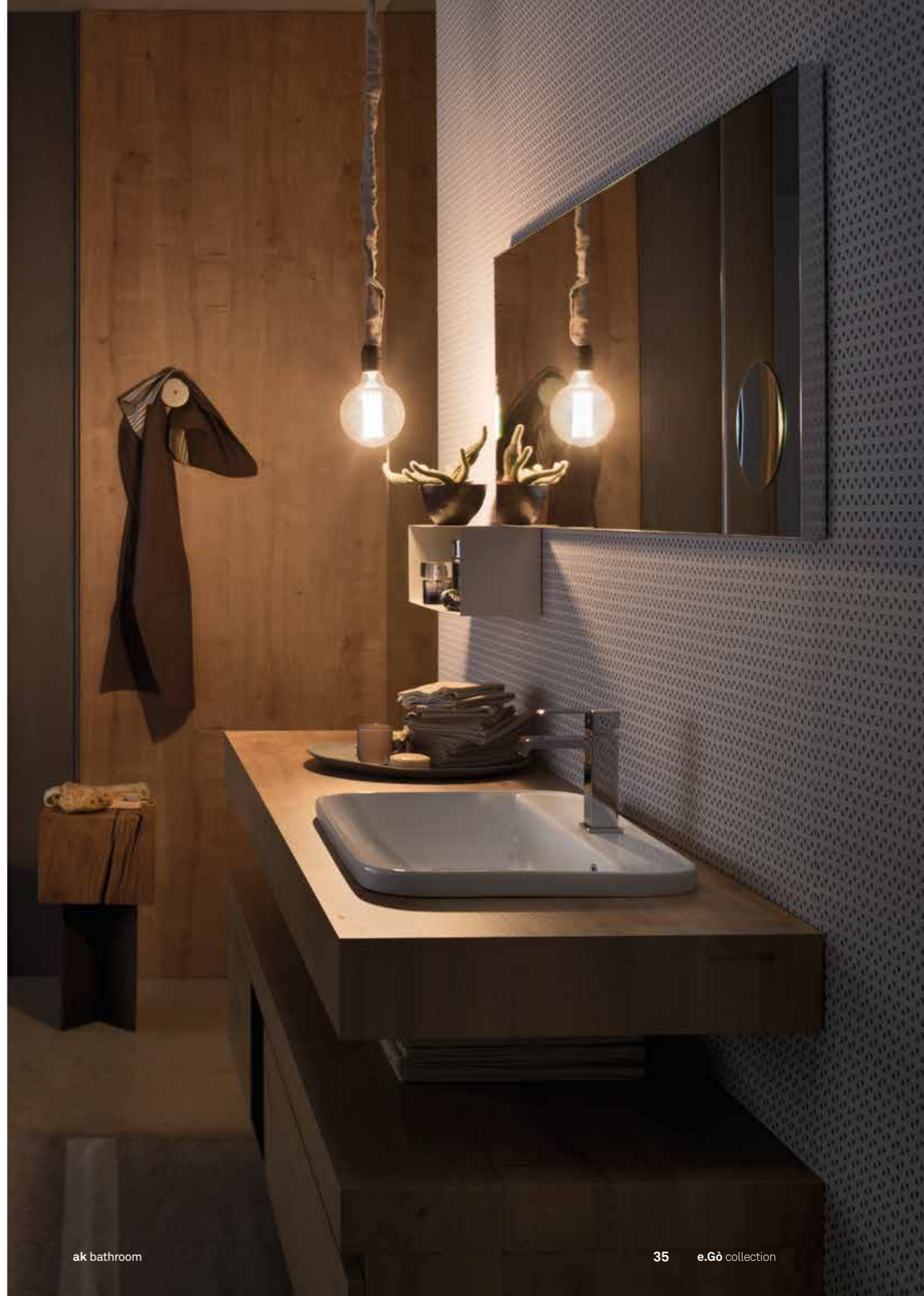

Prendere ispirazione
dalla natura

Gli elementi della composizione sembrano svilupparsi spontaneamente gli uni in relazione agli altri. Per un effetto finale di grande naturalezza.

Take inspiration
from nature

The elements in this composition seemingly unfold spontaneously, in relation to one another. The overall effect is extremely natural.



E.GÒ 68

L 155 P 51 cm
+ pensili / + wall units
photo

Integrato

Top con lavabo integrato in
Unicolor stratificato HPL Bianco
Dax L 105 x P 51 x Sp. 1 cm
Top with integrated
washbasin in Unicolor HPL
Bianco Dax sp.1 cm



Base L. 155 / Base unit
finitura / finish
FRASSINO BIANCO
particolari laccato
Canapa opaco - details in
matt Canapa lacquer

Specchiera / Mirror
Filo lucido L 70 x H 112,5
con faretto -
with spotlight **Quad**



Le sagome si riducono all'essenziale, i volumi assumono forme primarie. Il risultato è un bagno minimal e di grande fascino, in cui niente manca e niente è di troppo.

The silhouette is reduced to a minimum and the composition takes on a primary form. The result is a minimalist bathroom with maximum appeal, where nothing is missing and nothing is too much.



Faretto Quad

L 15 H 15 sp. 1,2 cm

finiture / finish
In plexiglass bianco
con luce led
In white Plexiglas
with LED light

Potenza 6W - Classe A++
Lumen 480 - Kelvin 6000

E.GÒ 69

L 145 P 51 cm
+ pensili / wall units
photo

Integrato
Lavabo integrato ovale
Integrated oval washbasin



Base L. 145 / Base unit
finitura / finish
LACCATO CENERE OPACO
particolari Terra opaco
details in matt Terra

Top
finitura / finish
Cristallo sabbiato
Terra sp.1.5 cm

Specchiera / Mirror
Norma sagomata - shaped





In perfetto equilibrio le due colonne pensili, simmetriche e inverse. La specchiera è touch: con un semplice tocco il profilo a led si illumina.

The two tall wall units are perfectly balanced, symmetrical and inverse. The mirror unit is touch-sensitive; tap the edge to turn on the LED light.

→
Stupire con un
arredo futuristico

Specchiera Norma

L 75 H 75 cm

Con bordo sottile in plexiglass illuminato a led che diffonde la luce

It has a slender Plexiglas rim with LEDs that distribute the light





Materiali dalle sembianze fluide
Fluid materials

Il top in cristallo sabbato con lavabo integrato dà all'arredobagno un aspetto tenue ed evanescente. Un effetto accentuato dalla tonalità neutra della base.

The etched glass top with a built-in washbasin gives the bathroom furniture a tenuous, evanescent look. This effect is accentuated by the neutral tone of the base unit.



La base è sospesa mentre i fianchi a terra creano assieme al top una cornice di spessore: la composizione è il risultato di una doppia ispirazione, tra il bianco dei lavabi e delle ante e la matericità del piano.

The base is wall-mounted whereas the floorstanding sides together with the top, create a thick frame: the arrangement is based on twin inspiration, somewhere between the white of the wash basins and doors and the material presence of the top.

E.GÒ 23

L 187 P 51 cm
photo



Fall
Lavabi "tutto fuori"
in teknorit - Countertop
washbasins in Teknorit



Base L. 187 / Base unit
finitura / finish
**LARICE MONOCOLORE
BIANCO**

Top
finitura / finish
Unicolor Cemento sp.6 cm

Specchiera / Mirror
Tonda con led - with leds
faretti - spotlight **Ridley**





E.GÒ 55

L 95 P 38 cm
photo

Select

Lavabo consolle
in ceramica bianca
White ceramic
console washbasin



Base L. 165 / Base unit
finitura / finish
ARES 50 SOLARE
particolati Salvia opaco
details in matt Salvia

Specchiera / Mirror
Satellite



→ Dare forma a idee nuove
per il bagno



Un braccio consente di muovere lo specchio con profilo luminoso. Una soluzione ingegnosa, che si abbina all'essenzialità della base per un effetto hi-tech.

The arm makes the mirror with edge lighting mobile. This ingenious solution tones perfectly with the sleek look of the base unit and creates a hi-tech feel.

Specchiera Satellite

L 75 H 80 cm

Con telaio cromato orientabile e specchio ingranditore retroilluminato

It features an adjustable chrome frame and a backlit magnifying mirror

→
Razionalizzare la parete
con i pensili

I sottili pensili a giorno in metallo permettono di personalizzare la schiena, scegliendo un colore a contrasto.

Structure the wall with units

These slender open-fronted wall units in metal can be used to personalise the back, with a choice of contrasting colours.





Arredare il bagno con un
design scultoreo



E.GÒ 26

L 170 P 38/51 cm
+ pensili / + wall units

Boule
Lavabo incasso
in teknorit - Built-in
washbasin in Teknorit



Base L. 170 / Base unit
finitura / finish
SHERWOOD LUNA
particolari - details
Sherwood Polvere

Top
finitura / finish
Unicolor Grigio Venato sp.6 cm

Specchiera / Mirror
Filo lucido L 50 x H 105
con faretto - spotlight **Spark**



E.GÒ 21

L 106 P 51 cm
+ mensole / shelves
photo

Drop
Lavabo consolle
in ceramica bianca
White ceramic
console washbasin



Base L. 106 / Base unit
finitura / finish
ROVERE TRANCÈ CANAPA

Specchiera / Mirror
Filo lucido L 70 x H 112,5 cm
con faretto - spotlight Klee

→
Dare risalto a tutti i
particolari

**Le dimensioni del lavabo consolle enfatizzano
l'effetto della maniglia a gola:
il dettaglio diventa protagonista.**

Emphasising
every detail

The size of the console
basin emphasises the
effect of the groove
handle: this feature
becomes the focal point.





→
Raddoppiare la bellezza
e la funzionalità

Il monoblocco della base sostiene un doppio lavabo dalla capienza generosa. Una soluzione curata fin nei minimi dettagli, che rende il bagno ancora più accogliente.

The single base unit supports a double, generously sized washbasin. This neat solution takes care of the details and makes the bathroom even more welcoming.

E.GÒ 27

L 121 P 51 cm
photo

Lego
Lavabo consolle doppia
vasca in mineralguss
Twin console washbasin
in Mineralguss

Base L. 120 / Base unit
finitura / finish
SHERWOOD PLATINO

Specchiera / Mirror
Contenitore **Cabrio**
L 120 x H 75 con faretto
Spark - Cabrio storage mirror
unit with **Spark** spotlight



Toni vibranti e geometrie purissime. Lo stile moderno è ribadito da forme semplici e rigorose e riscaldato dall'accostamento del rosso e del bianco. Per un arredobagno di grande tendenza.

Bright tones and sleek shapes. The modern style comes through in the simple, structured shapes and is softened by the use of red and white together. The result is bathroom furniture right on trend.

E.GÒ 64

L 120 P 51 cm

City
Lavabo consolle
in mineralguss
Console washbasin
in Mineralguss



Base L. 120 / Base unit
finitura / finish
LACCATO LAMPONE OPACO

Specchiera / Mirror
Sghemba

Pensili / Wall units
In vetro con schienale laccato
lampone opaco L 25 cm
Glass with matt Lampone
lacquered back panel W. 25 cm



E.GÒ 63

L 105 P 51 cm
+ colonne / tall units
photo



Nespola 45

Lavabo in ceramica bianca
Washbasin in white ceramic



Base L. 105 / Base unit
finitura / finish
LACCATO TERRANOVA OPACO
particolari larice bicolore
canapa - details in two-tone
Canapa larch

Top
finitura / finish
Unicolor stratificato HPL
Mokaccino
L 105 x P 51 x sp. 1 cm

Specchiera / Mirror
Filo lucido L 50 x H 105
con faretto - spotlight Aalto





→ Sperimentare con la
composizione

Una grande colonna in
sospensione, progettata per
contenere tutto il necessario
in un bagno bello e organizzato.

This large, floating tall unit
has been designed to store
everything you need in a neat
and tidy bathroom.



La specchiera svolge una doppia funzione: riflette e contiene. Anche il faretto lineare testimonia una scelta che risponde allo stile oltre che alla praticità.

The mirror unit is dual-purpose: reflecting and storing. The linear spotlight is another example of a design choice that considers style as well as practicality.

→
Riporre e custodire
dietro lo specchio

E.GÒ 70

L 85 P 51 cm
photo

Tak
Lavabo consolle in
ceramica - Ceramic
console washbasin

Base L.85 / Base unit
LARICE BICOLORE ECRÙ
Specchiera / Mirror
contenitore **Easy** L 85 x H 75
con faretto **Adler**
Easy storage mirror unit
with **Adler** spotlight



→
Modellare il bagno
con eleganza

**Tutta la grazia e la versatilità della ceramica,
plasmata in un lavabo console
dalle forme morbide e delicate.**

Shaping the bathroom,
elegantly

The grace and versatility
of ceramic, moulded into
a console basin with a
soft and delicate form.





E.GÒ 20

L 155 P 51 cm

Integrato

Lavabo integrato ovale
Integrated oval washbasin

Base L. 155 / Base unit

finitura / finish

ROVERE TRANCHÈ ECRÙ

Top

Teknorit sp. 12 cm

Specchiera / Mirror

Filo lucido L 85 x H 50
con faretto - spotlight **Filo**

ak bathroom

→
Romperre gli schemi e
animare l'arredo



Pieni e vuoti sono distribuiti con gusto e i volumi si rincorrono lungo tutta la composizione. Un arredobagno che combina il movimento con l'eleganza.

Full and empty spaces are arranged tastefully, and the pattern continues throughout the composition. This bathroom composition combines movement and elegance.

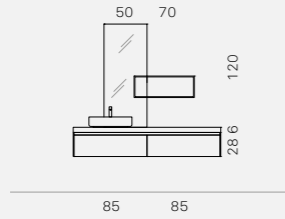

E.GÒ 61 (page 04-05)
L 170 x P 51 cm

Kratere
Lavabo "tutto fuori"
in ceramica bianca

Base L. 170
Finitura **Frassino bianco**

Top
Finitura Bianco opaco sp. 7 cm

Specchiera
Filo lucido L 50 x H 120
con faretto Aalto

Kratere
Washbasin countertop
white ceramic

Base unit W. 170
Finish **Frassino bianco**

Top
Finish Bianco opaco sp. 7 cm

Mirror
Polished edge W. 50 x H. 120 cm
with Aalto spotlight

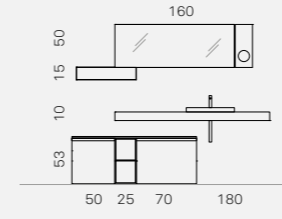

E.GÒ 66 (page 18-19)
L 230 x P 51 cm

Dandy
Lavabo incasso sopra piano
in ceramica bianca

Base L. 145
Finitura **Larice bianco**
particolari laccati cascata opaco

Top
Finitura Larice bianco sp.10 cm

Specchiera
con Ala e specchio ingranditore
L 165 x H 50 cm

Dandy
Washbasin Built-in
countertop in white ceramic

Base unit W. 145
Finish **Larch bianco**
details in matt Cascata lacquer

Top
Finish Larch bianco sp.10 cm

Mirror
with Ala and mirror
W. 165 x H. 50 cm

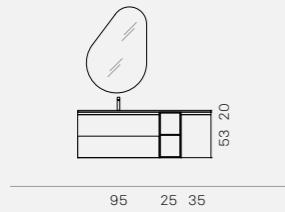

E.GÒ 62 (page 08-09)
L 155 x P 51 cm

Integrato
Top con lavabo
integrato in Unicolor
stratificato HPL Cesar-Brown
L 155 x P 51 x sp. 1 cm

Base L. 155
Finitura **Yosemite chiaro**
particolari laccati Platino

Specchiera
Bà-Bà

Integrato
Top with Washbasin
integrated in Cesar-Brown HPL
composite Unicolor
W. 155 x D. 51 x sp. 1 cm

Base unit W. 155
Finish **Yosemite chiaro**
details in lacquered Platino

Mirror
Bà-Bà

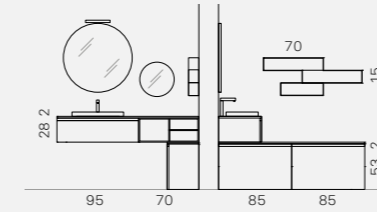

E.GÒ 67 (page 22-23)
L 165/170 x P 51/38 cm

Dandy
Lavabo incasso
in ceramica bianca

Base
Finitura **Laccata fiordaliso opaco**
particolari laccati petrolio opaco

Top
Finitura Marmo
Bianco Olimpo sp.2 cm

Specchiera
Tonda Ø 80 cm
con luci led Ø 40 cm

Dandy
Washbasin built-in
in white ceramic

Base unit
Finish **Laccata fiordaliso opaco**
details in matt Petrolio lacquer

Top
Finish Marmo
Bianco Olimpo sp.2 cm

Mirror
Tonda Ø 80 cm
with led lights Ø 40 cm

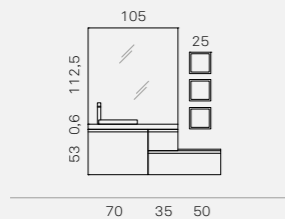

E.GÒ 54 (page 14-15)
L 155 x P 51 cm

Dandy
Lavabo incasso
in ceramica bianca

Base L. 155
Finitura **Ares 50 solare**
particolari laccato navy opaco

Top
Finitura Unicolor
Graffiato sp.6 cm

Specchiera
Filo lucido L 105 x H 112,5 cm
con faretto Fedra

Dandy
Washbasins built-in
white ceramic

Base unit W. 155
Finish **Ares 50 solare**
details in matt Navy lacquer

Top
Finish Unicolor
Graffiato sp.6 cm

Mirror
Polished edge W. 105 x H. 112,5 cm
with Fedra spotlight

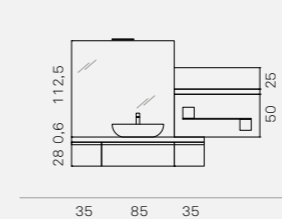

E.GÒ 53 (page 28-29)
L 155 x P 51 cm + magnetica

Prugna
Lavabo "tutto fuori"
in ceramica bianca

Base L. 155
Finitura **Olmo jerez canapa**

Top
Finitura Unicolor Cesar-Brown
sp.6 cm

Specchiera
Filo lucido L 120 x H 112,5 cm
con faretto Regolo

Prugna
Washbasin countertop
in white ceramic

Base unit W. 155
Finish **Olmo jerez canapa**

Top
Finish Unicolor Cesar-Brown
sp.6 cm

Mirror
Polished edge W. 120 x H. 112,5 cm
with Regolo spotlight

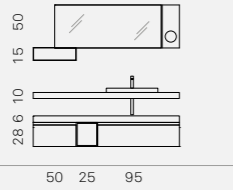

E.GÒ 65 (page 32-33)
L 170 x P 51 cm

Giò
Lavabo incasso
in ceramica bianca

Base L. 170
Finitura **Rovere Arlington**

Top
Finitura Rovere Arlington sp.10 cm

Specchiera
Con Ala e specchio ingranditore
L 165 x H 50 cm

Giò
Washbasins built-in
white ceramic

Base unit W. 170
Finish **Rovere Arlington**

Top
Finish Rovere Arlington sp.10 cm

Mirror
with Ala and magnifying mirror
W. 165 x H. 50 cm

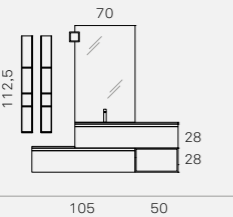

E.GÒ 68 (page 38-39)
L 155 x P 51 cm + pensili - wall units

Integrato
Top con lavabo integrato
in Unicolor stratificato HPL
Bianco Dax L 105 x P 51 x Sp. 1 cm

Base L. 155
Finitura **Frassino bianco**
particolari laccato canapa opaco

Specchiera
Filo lucido L 70 x H 112.5
con faretto Quad

Integrato
Top with washbasin integrated
in Unicolor HPL Bianco Dax
W. 105 x D. 51 x Sp. 1 cm

Base unit W. 155
Finish **Frassino bianco**
details in matt Canapa lacquer

Mirror
Filo Lucido W. 70 x H. 112.5 cm
with Quad spotlight

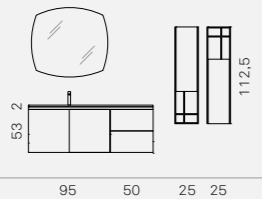

E.GÒ 69 (page 42-43)
L 145 x P 51 cm + pensili - wall units

Integrato
Lavabo integrato ovale

Base L. 145
Finitura **Laccato cenere opaco**
particolari Terra opaco

Top
Finitura Cristallo sabbiato
Terra sp.1.5 cm

Specchiera
Norma sagomata

Integrato
Washbasins integrated oval

Base unit W. 145
Finish **Laccato cenere opaco**
details in matt Terra

Top
Finish Cristallo sabbiato
Terra sp.1.5 cm

Mirror
Norma shaped

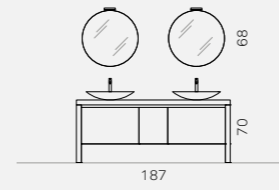

E.GÒ 23 (page 48-49)
L 187 x P 51 cm

Fall
Lavabi "tutto fuori"
in teknorit

Base L. 187
Finitura **Larice**
monocolore bianco

Top
Finitura Unicolor Cemento sp.6 cm

Specchiera
Tonda con led e faretto
Ridley

Fall
Washbasin Countertop
in Teknorit

Base unit W. 187
Finish **Single-tone**
Bianco larch

Top
Finish Unicolor Cemento sp.6 cm

Mirror
Tonda with LEDs and Ridley
spotlight

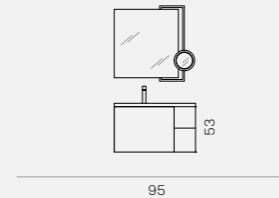

E.GÒ 55 (page 50-51)
L 95 x P 38 cm

Select
Lavabo consolle
in ceramica bianca

Base L. 165
Finitura **Ares 50 solare**
particolati Salvia opaco

Specchiera
Satellite

Select
Washbasin console
white ceramic

Base unit W. 165
Finish **Ares 50 solare**
details in matt Salvia

Mirror
Satellite

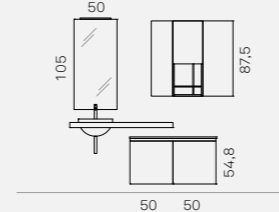

E.GÒ 26 (page 56-57)
L 170 x P 38/51 cm + pensili - wall units

Boule
Lavabo incasso
in teknorit

Base L. 170
Finitura **Sherwood luna**
particolari Sherwood Polvere

Top
Finitura
Unicolor Grigio Venato sp.6 cm

Specchiera
Filo lucido L 50 x H 105
con faretto Spark

Boule
Washbasin built-in
in Teknorit

Base unit W. 170
Finish **Sherwood luna**
details in Sherwood Polvere

Top
Finish
Unicolor Grigio Venato sp.6 cm

Mirror
Filo Lucido W. 50 x H. 105 cm
with Spark spotlight

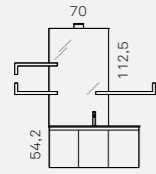

E.GÒ 21 (page 58-59)
L 106 x P 51 cm + mensole - shelves

Drop
Lavabo consolle
in ceramica bianca

Base L. 106
Finitura **Rovere tranchè canapa**

Specchiera
Filo lucido L 70 x H 112,5 cm
con faretto Klee

Drop
Washbasins console
white ceramic

Base unit W. 106
Finish **Rovere tranchè canapa**

Mirror
Filo Lucido W. 70 x H. 112.5 cm
with Klee spotlight

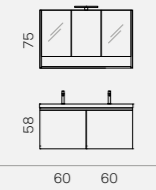

E.GÒ 27 (page 62-63)
L 121 x P 51 cm

Lego
Lavabo consolle doppia vasca
in mineralguss

Base L. 120
Finitura **Sherwood platino**

Specchiera
Contenitore Cabrio
L 120 x H 75 con faretto Spark

Lego
Washbasin Twin console
in Mineralguss

Base unit W. 120
Finish **Sherwood platino**

Mirror
Cabrio storage unit W. 120 H. 75 cm
with Spark spotlight

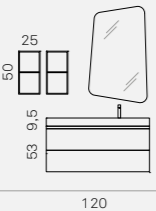

E.GÒ 64 (page 64-65)
L 120 x P 51 cm

City
Lavabo consolle
in mineralguss

Base L. 120
Finitura **Laccato lampone opaco**

Specchiera
Sghemba

Pensili
In vetro con schienale laccato
lampone opaco L 25 cm

City
Washbasins console
in Mineralguss

Base unit W. 120
Finish **Matt Lampone lacquered**

Mirror
Sghemba

Wall units
Glass with matt Lampone
lacquered back panel W. 25 cm



E.GÒ 63 (page 66-67)
L 105 x P 51 cm + colonne - tall units

Nespolo 45
Lavabi in ceramica bianca

Base L. 105
Finitura **Laccato terranova opaco**
particolari larice bicolore canapa

Top
Finitura Unicolor stratificato HPL
Mokaccino L 105 x P 51 x sp. 1 cm

Specchiera
Filo lucido L 50 x H 105
con faretto Aalto

Nespolo 45
Washbasin in white ceramic

Base unit W. 105
Finish **Matt Terranova lacquered** with
details in two-tone Canapa larch

Top
Finish Unicolor HPL Mokaccino
W. 105 x D. 51 x sp. 1 cm

Mirror
Filo Lucido W. 50 x H. 105 cm
with Aalto spotlight

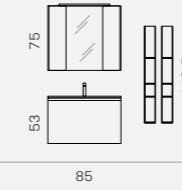

E.GÒ 70 (page 70-71)
L 85 x P 51 cm

Tak
Lavabo consolle
in ceramica bianca

Base L. 85
Finitura **Larice bicolore ecrù**

Specchiera
contenitore Easy L 85 x H 75
con faretto Adler

Tak
Washbasin console
white ceramic

Base unit W. 85
Finish **Larice bicolore ecrù**

Mirror
Easy storage unit W. 85 x H. 75 cm
with Adler spotlight

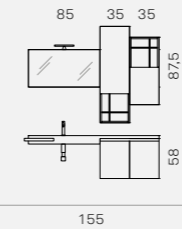

E.GÒ 20 (page 74-75)
L 155 x P 51 cm

Integrato
Lavabo integrato ovale

Base L. 155
Finitura **Rovere tranchè ecrù**

Top
Finitura Teknorit sp. 12 cm

Specchiera
Filo lucido L 85 x H 50
con faretto Filo

Integrato
Washbasin integrated oval

Base unit W. 155
Finish **Rovere tranchè ecrù**

Top
Finish Teknorit sp. 12 cm

Mirror
Filo Lucido W. 85 x H. 50 cm
with Filo spotlight

Larice

Larch



Bianco

Ecrù

Canapa

Frassino

Ash



Bianco

Yosemite

Yosemite



Chiaro

Rovere

Oak



Ecrù

Canapa

Marrone

Rovere

Oak



Arlington

Nodo



Bianco

Avorio

Talco

Tabacco

Sherwood

+ 50 laccati opaco



Luna

Polvere

Platino

Burn

Olmo



Bianco

Grigio

Canapa

Marrone

Ares



50 solare

53 lunare

Colore

Colour



Bianco
opaco / lucido

Agata
opaco / lucido

Magma
opaco / lucido

Grigio antracite
opaco / lucido

Colore laccato opaco e lucido

Matte and gloss lacquered color



Inox

Taupe

Nero

Grigio fumo
di Londra

Cenere

Nebbia

Grigio Perla

Brezza



Bianco

New
Pergamon

Ecrù

Juta

Canapa

Terranova

Brown

Cacao



Terra

Visone

Verde bosco

Verde oliva

Verde Twigg

Verde salvia

The verde

Germoglio



Fiordaliso

Vaniglia

Giallo Polline

Arancio

Mattone

Rosso Fuoco

Bordeaux

Rosso India



Blu Night

Blu Marin

Navy

Petrolio

Cascata

Cielo

Acquamarina

Sky

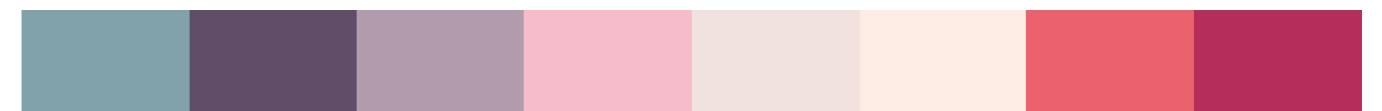

Nuvola

Lavanda

Glicine

Rosa confetto

Lilla light

Bocciolo

Geranio

Amarena



Lampone



Platino*
Laccato opaco / Matt lacquer

Design e coordinamento: Arcom
Progetto Grafico: Lokomotiv
Foto: Indoor
Art direction photo and styling: Rossi & Co.
Fotolito: Luce
Stampa: OGM
Stampato: Febbraio 2018

ak
bathstyle

By ARCOM srl

33070 Tamai di Brugnera (PN) Italy

Viale Europa 4

T. +39.0434.613619 / 1573020

F. +39.0434.608137

info@arcombagno.com

www.arcombagno.com

 **ATMA**
INDUSTRIE DEL MOBILE

e-mail: gruppoatma@gruppoatma.it

<http://www.gruppoatma.it>

e.Ly J

→
anta con maniglia a gola J
door with J-groove handle

ROVERE
ARLINGTON
SHERWOOD
ARES
OLMO
COLORE



e.Ly J

→
anta con maniglia a gola J
door with J-groove handle

Il potere espressivo dei materiali
The expressive power of different materials

Forme e materiali si incontrano ed è subito design. Colori, lucidi e opachi, o venature, naturali e tinte, rivestono e vestono l'arredobagno.

Shapes and materials combine to make the design. Matt and glossy colours, and natural and stained wood grain decorate and dress the bathroom furniture.

Finiture disponibili /
Finishes available

1. ROVERE / NEW OAK

Arlington

2. SHERWOOD

4 tonalità + 50 colori laccati (opaco)
4 shades + 50 lacquered colours (matt)

3. ARES

2 tonalità - 2 shades

4. OLMO

4 tonalità - 4 shades

COLORE / COLOUR

50 colori laccati (opaco e lucido)
50 lacquered colours (matt and glossy)

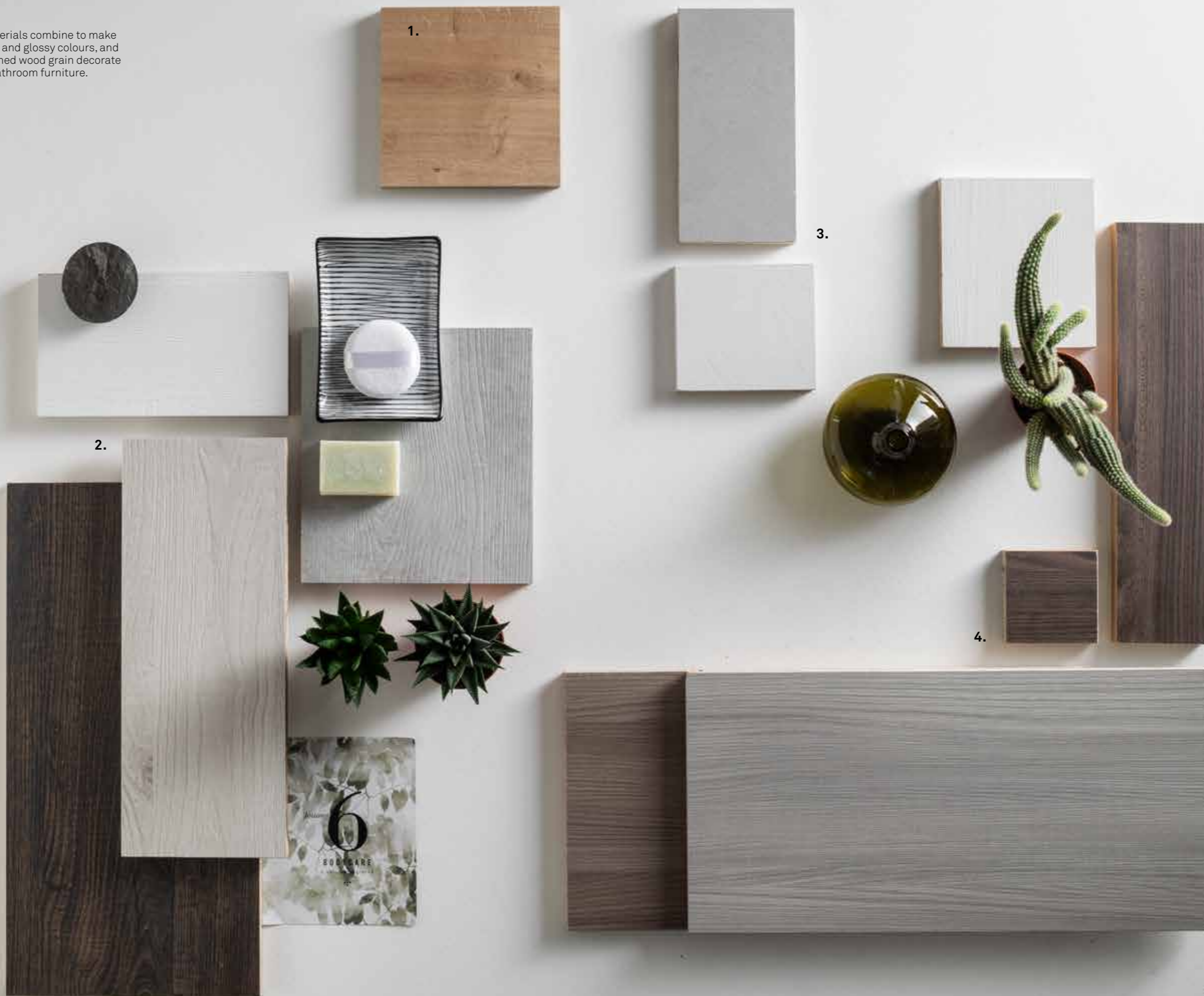

e.Ly J

L'apertura gola a J caratterizza le ante nell'estetica e nella funzionalità: un segno che sottolinea il mobile e garantisce una presa sicura.

→
Aprire con la semplicità
della gola

Opening doors has never been simpler than with the groove

The J groove is the feature element on the door, both in terms of the look and its practical uses. It characterises the unit and guarantees a good grip.

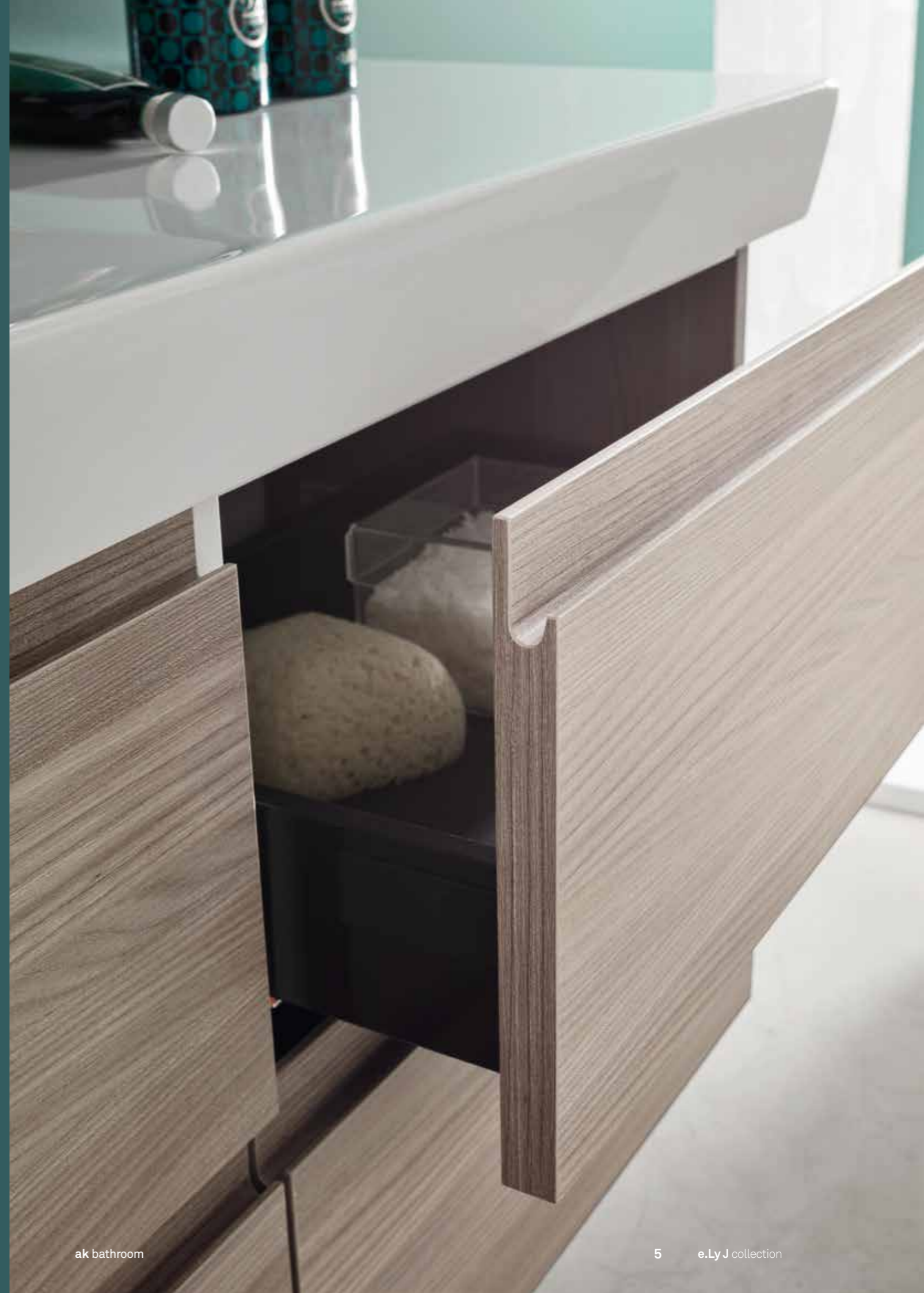



E.LY J 62

L 120 P 38 cm
photo

Pampa
Lavabo L. 120
vasca sx in ceramica bianca
Washbasin W. 120
Left-hand basin in
white ceramic



Base L. 120 / Base unit
finitura / finish
OLMO JEREZ CANAPA

Specchiera / Mirror
Tonda diametro 80 cm
con faretto Circllet
Tonda, 80 cm diameter
with Circllet spotlight



Accostamenti liberi e naturali
Free and natural pairings

La luminosità della ceramica si abbina alle venature dell'olmo e insieme creano una composizione naturale da tutti i punti di vista.

The ceramic adds a light and bright touch, which combines with the elm wood grain to create a natural composition, from every point of view.



→
Arredare con la purezza
delle forme

Pampa

L 120 P 40 H 7,5 cm

finiture / finish
ceramica / ceramic

dimensioni disponibili / size
L 50 - 60 - 70 - 85 - 95 - 105
P 40

misure interno vasca /
internal basin size
L 69 P 28 H 11,5 cm

E.LY J 68

L 165 P 51 cm
photo

Integrato

Lavabo L. 165
in unicolor stratificato (HPL)
Sabbia Creola sp. 1 cm
Washbasin W. 165
in unicolor HPL, Sabbia Creola,
1 cm thick



Base L. 165 / Base unit
finitura / finish
OLMO JEREZ CANAPA
particolari Verde Oliva opaco
details in matt Verde Oliva

Specchiera / Mirror
Tonda diametro 80 e 40 cm
con faretto Circllet
Tonda, 80 cm and 40 cm
diameter with Circllet spotlight





Tonda

specchiera / mirror
Ø 80 - 40 cm

fareto / spotlight
Cirlet

L'inserto a giorno apre al colore The open-fronted insert brings colour to the design

L'elemento a giorno si inserisce nel mobile: apre l'angolo, crea un nuovo spazio e aggiunge un tocco di colore all'olmo.

The open element is fitted into the unit, opening up the corner to create a new space and add a splash of colour to the elm wood.

Portare nuove geometrie
nell'arredo



Integrato

L 165 P 51 sp. 1 cm

finiture / finish
Lavabo integrato rettangolare
in Unicolor stratificato (HPL)
Sabbia Creola

Rectangular integrated
washbasin in unicolour HPL,
Sabbia Creola

misure interno vasca /
internal basin size
L 60 P 31 H 10 cm





E.LY J 61

L 165 P 38 cm
photo



Susina
Lavabi in ceramica bianca
Washbasins in white ceramic



Base L. 165 / Base unit
finitura / finish
OLMO JEREZ BIANCO
particolari Sky opaco
details in matt Sky

Specchiera / Mirror
Half con faretto **Cremino**
Half with **Cremino** spotlight





La coppia di lavabi raddoppia la funzionalità del mobile e la praticità dell'ambiente. Un bagno per due e tanto spazio per tutto.

The twin basins double the utility of this unit, and the practical features in the space. A bathroom for two, and plenty of space for everything.



Susina

L 54 P 30 H 18 cm



finiture / finish
ceramica bianca o nero opaco
white ceramic or matt black

misure interno vasca /
internal basin size
L 52 P 28 H 15 cm

E.LYJ 37

L 120 P 51 cm
+ pensile - wall unit
photo

Jag
Lavabo consolle L. 95
in mineralguss
Console washbasin W. 95
in Mineralguss



Base L. 120 / Base unit
finitura / finish
SHERWOOD BURN

Specchiera / Mirror
Hendrick's con luci led
Hendrick's with LED lights



Esprimere il design con
il calore del legno

Una vera sensazione di natura A real sense of nature

Le venature sono marcate e
trasmettono la matericità del
legno appena tagliato.
L'arredo ha un fascino naturale.

The grain is accentuated to
recreate the textured feel of
freshly cut wood.
Furniture with natural appeal.

E.LY J 66

L 170 P 51 cm
photo

Giò
Lavabo incasso soprapiano
L 60 x P 40 x H 3.2 cm
in ceramica bianca
Recessed countertop
washbasin in white ceramic

Base L. 170 / Base unit
finitura / finish
OLMO JEREZ GRIGIO

Top e Pensile
finitura / finish
ARES 50 SOLARE

Specchiera / Mirror
filo lucido L 140 x H 50 cm
con faretto **Ufo**
polished edge W. 140 x H. 50 cm
with **Ufo** spotlight





Nelle tonalità più fredde del grigio, le venature hanno un carattere più moderno e si adattano perfettamente al design lineare dell'arredo.

In the colder grey shades, the wood grain creates a more modern character, and adapts perfectly to the linear furniture design.



Giò

L 60 P 40 H 3,2 cm

Lavabo con rubinetto
sulla ceramica
Washbasin with tap
on ceramic

misure interno vasca /
internal basin size
L 57 P 28 H 12 cm

→
Valorizzare la gola con
un design lineare

**La gola a J è il tratto distintivo di basi e pensili.
Posizionata sul lato superiore
o inferiore dell'anta dà ulteriore
risalto alle linee nette.**

A linear design puts the
groove in its best light

The J groove is the
feature element on the
base units and wall
units. Positioned on the
top or side of the door,
it emphasises the clean
lines of this unit.



E.LY J 65

L 140 P 51 cm
photo



Softly 60

Lavabo in ceramica bianca
Washbasin in white ceramic



Base L. 140 / Base unit
finitura / finish
OLMO JEREZ BIANCO
particolari Ares 53 lunare
details in Ares 53 Lunare

Top
finitura / finish
ARES 53 LUNARE sp.1.8 cm

Specchiera / Mirror
filo lucido L 60 x H 112.5 cm
con faretto **Nite**
polished edge W. 60 x H. 112.5
cm with **Nite** spotlight





L'essenzialità del bianco fa risaltare la texture dell'olmo e si armonizza con i toni neutri del top e del modulo a giorno. L'insieme è soft.

The minimalist white colour brings out the textured elm wood, and blends in with the neutral shades of the top and open element. The result is a soft overall look.

Softly 60

L 60 P 43 H 17 cm



finiture / finish
ceramica bianca
white ceramic

misure interno vasca /
internal basin size
L 57 P 30 H 14,5 cm





→
Trovare un posto per tutto
il necessario

I pensili a giorno danno al bagno ulteriori possibilità di personalizzazione. Colori e geometrie arredano e allo stesso tempo decorano.

Find a place for everything you need

The open wall units make extra personalisation possible in bathroom space. Colours and shapes both furnish and decorate the space.



E.LY J 36

L 176 P 51 cm
photo

Jag 96
Lavabo consolle in
mineralguss
Console washbasin in
Mineralguss



Base L. 95 / Base unit
finiture / finish
SHERWOOD LUNA

Specchiera / Mirror
Tonda diametro 80 cm
con faretto **Penny**
Tonda, 80 cm diameter
with **Penny** spotlight

E.LY J 69

L 210 P 51 cm
photo

Integrato

Lavabo L 160 cm in teknoril
bianco sp.12 cm
Washbasin W. 160 cm in white
Teknoril, 12 cm thick

Base L. 135 / Base unit
finitura / finish
ROVERE ARLINGTON

Specchiera / Mirror
Tonda diametro 80 cm
con luci led
Tonda, 80 cm diameter
with LED lights





Il top dal forte spessore si appoggia sulla base in rovere. Il bianco assoluto si armonizza con i nodi e le venature in una composizione dallo stile nordico.

The chunky top rests on an oak base unit. The pure white colour harmonises with the knots and grain in the wood, to create a Nordic-inspired composition.



mensole

L 70 P 12,5 H 12,5 cm

finiture / finish
scocca in metallo bianco opaco
e schiena in rovere Arlington

matte white metal
and back in Arlington oak

E.LYJ 70

L 170 P 51 cm
photo

Integrato
Lavabo L 170 cm in cristallo
Taupe sp.1 cm
Washbasin W. 170 cm in Taupe
glass, 1 cm thick



Base L. 170 / Base unit
finitura / finish
ROVERE ARLINGTON

Specchiera / Mirror
filo lucido L 95 H 75 cm
con faretto Nite 800
polished edge W. 95 H. 75 cm
with Nite 800 spotlight





→ Dare forma alla parete con
pensili chiusi e aperti

**Tutta la bellezza della semplicità
Simple beauty**

La presenza materica del rovere accoglie il lavabo integrato in cristallo. La natura esprime il suo lato più elegante e raffinato.

The textured oak wood holds the built-in glass washbasin. Nature's most refined and elegant side shines through.



La versatilità estetica del cristallo
Versatile aesthetics with glass

Il cristallo colorato dà forma al lavabo e a una comoda superficie d'appoggio. Pratico e bello, si abbina perfettamente alle venature.

The coloured glass gives shape to the washbasin and provides a handy work surface. Practical and attractive, it tones perfectly with the wood grain.



→ Cromie e contrasto
tra il cristallo e il legno

Integrato

L 170 P 51 sp.1 cm

finiture / finish
cristallo Taupe

misure interno vasca /
internal basin size
L 72 P 31 H 15 cm



→
Creare composizioni originali
sulla parete

E.LY J 38

L 150 P 51 cm
+ pensili - wall units
photo

Lego 61
Lavabo consolle in mineralguss
Console washbasin in Mineralguss

Base L. 60 / Base unit
finiture / finish
SHERWOOD BURN
particolari / details
Sherwood polvere

Top
Unicolor Cemento L 150 cm
Unicolour Cemento

Specchiera / Mirror
Contenitore **Cabrio** con
faretto **Filo - Cabrio** storage unit
with **Filo** spotlight





Il total white del top con il lavabo si abbina alla modernità della base in laccato: bianco e blu sono una coppia perfetta nell'arredobagno.

The all-white top and basin match the modern lacquered base unit below. White and blue make the perfect pair for bathroom furniture.

E.LYJ 72

L 95 P 51 cm
photo

Nespola 45

In ceramica bianca con top bianco opaco sp.1.8 cm
In white ceramic with matt white top, 1.8 cm thick



Base L. 95 / Base unit
finitura / finish
CIELO OPACO
con particolari Bianco e Verde Twiggy opaco
Matt Cielo with details in Bianco and matt Verde Twiggy

Specchiera / Mirror
Sghemba





Unire estetica e praticità nei
complementi d'arredo

Nell'ambiente bagno, anche gli accessori hanno un ruolo importante: creano punti di appoggio e arredano con l'originalità del design.

Fusing aesthetics and practicality in the furnishing accessories

In the bathroom space, accessories are important too; they create useful surfaces and furnish the space with an original design.



E.LY J 39

L 85 P 51 cm
+ colonna - tall unit
photo

Roxi 85
Lavabo consolle in
mineralguss - Console
washbasin in Mineralguss



Base L. 85 / Base unit
finiture / finish
SHERWOOD PLATINO

Specchiera / Mirror
Contenitore **Cabrio** con faretto
Flipper - Cabrio storage unit
with **Flipper** spotlight



E.LYJ 71

L 140 P 38/51 cm
photo

Integrato
Lavabo L 140 cm in teknoril
7037 sp. 1.2 cm
Washbasin W. 140 cm
in Teknoril 7037, 1.2 cm thick



Base L. 140 / Base unit
finitura / finish
GIALLO POLLINE OPACO
con particolari cenere opaco
Matt Giallo Polline with
details in matt Cenere

Specchiera / Mirror
filo lucido L 70 H 112.5 cm
con faretto Spark
polished edge
with Spark spotlight





La base curva e colorata con lavabo integrato prosegue con una base dritta che dà più spazio al design a alla capacità di contenimento.

The curved, coloured base unit with a built-in washbasin has a straight base that leaves more room for design and storage space.

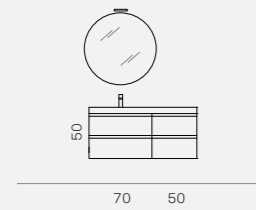

E.LY J 62 (page 06-07)
L 120 x P 38 cm

Pampa
Lavabo L. 120
vasca sx in ceramica bianca

Base L. 120
Finitura **Olmo jerez canapa**

Specchiera
Tonda diametro 80 cm
con faretto Circllet

Pampa
Washbasin W. 120
Left-hand basin in white ceramic

Base unit W. 120
Finish **Olmo jerez canapa**

Mirror
Tonda, 80 cm diameter
with Circllet spotlight

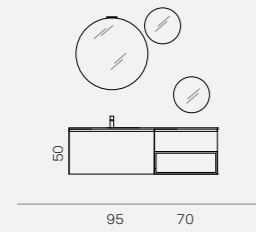

E.LY J 68 (page 10-11)
L 165 x P 51 cm

Integrato
Lavabo L. 165
in unicolor stratificato (HPL)
Sabbia Creola sp. 1 cm

Base
Finitura **Olmo jerez canapa**
particolari Verde Oliva opaco

Specchiera
Tonda diametro 80 e 40 cm
con faretto Circllet

Integrato
Washbasin W. 165
in unicolour HPL, Sabbia Creola,
1 cm thick

Base unit
Finish **Olmo jerez canapa**
Details in matt Verde Oliva

Mirror
Tonda, 80 cm and 40 cm diameter
with Circllet spotlight

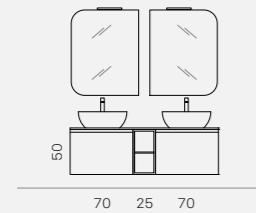

E.LY J 61 (page 16-17)
L 165 x P 38 cm

Susina
lavabi in ceramica bianca

Base L. 165
Finitura **Olmo jerez bianco**
particolari Sky opaco

Specchiera
Half con faretto Cremino

Susina
Washbasins in white ceramic

Base unit W. 165
Finish **Olmo jerez bianco**
Details in matt Sky

Mirror
Half with Cremino spotlight

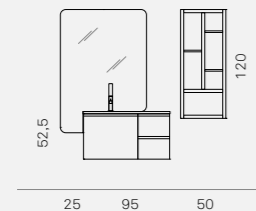

E.LY J 37 (page 20-21)
L 120 x P 51 cm + pensile - wall unit

Jag
lavabo consolle L. 95
in mineralguss

Base L. 120
Finitura **Sherwood burn**

Specchiera
Hendrick's con luci led

Jag
Console washbasin W. 95
in Mineralguss

Base unit W. 120
Finish **Sherwood burn**

Mirror
Hendrick's with LED lights

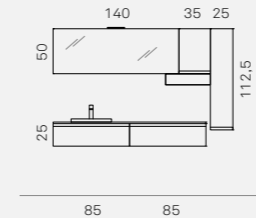

E.LY J 66 (page 22-23)
L 170 x P 51 cm

Giò
lavabo incasso soprapiano
L 60 x P 40 x H 3.2 cm
in ceramica bianca

Base L. 170
Finitura **Olmo jerez grigio**

Top e Pensile
Finitura **Ares 50 solare**
sp.1.8 cm

Specchiera
filo lucido L 140 x H 50 cm
con faretto Ufo

Giò
Recessed countertop washbasin
W. 60 x D. 40 x H. 3.2 cm
in white ceramic

Base unit W. 170
Finish **Olmo jerez grigio**

Top and Wall unit
Finitura **Ares 50 solare**
sp.1.8 cm

Mirror
polished edge W. 140 x H. 50 cm
with Ufo spotlight

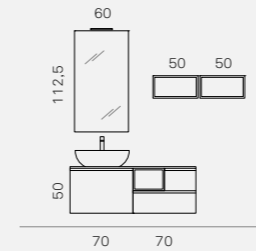

E.LY J 65 (page 28-29)
L 140 x P 51 cm

Softly 60
Lavabo in ceramica bianca

Base L. 140
Finitura **Olmo jerez bianco**
particolari Ares 53 lunare

Top
Finitura **Ares 53 lunare**
sp.1.8 cm

Specchiera
filo lucido L 60 x H 112.5 cm
con faretto Nite

Softly 60
Washbasin in white ceramic

Base unit W. 140
Finish **Olmo jerez bianco**
Details in Ares 53 Lunare

Top
Finish **Ares 53 lunare**
sp.1.8 cm

Mirror
polished edge W. 60 x H. 112.5 cm
with Nite spotlight

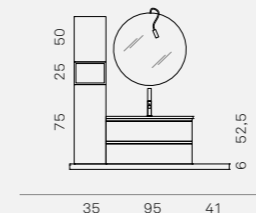

E.LY J 36 (page 34-35)
L 176 x P 51 cm

Jag 96
lavabo consolle in mineralguss

Base L. 95
Finitura **Sherwood luna**

Specchiera
Tonda diametro 80 cm
con faretto Penny

Jag 96
Console washbasin in Mineralguss

Base unit W. 95
Finish **Sherwood luna**

Mirror
Tonda, 80 cm diameter
with Penny spotlight

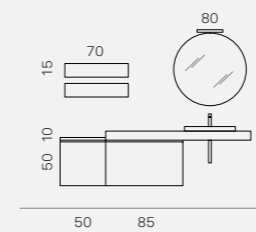

E.LY J 69 (page 36-37)
L 210 x P 51 cm

Integrato
Lavabo L 160 cm
in teknoril bianco sp.12 cm

Base L. 135
Finitura **Rovere arlington**

Specchiera
Tonda diametro 80 cm
con luci led

Integrato
Washbasin W. 160 cm in white
Teknoril, 12 cm thick

Base unit L. 135
Finish **Rovere arlington**

Mirror
Tonda, 80 cm diameter
with LED lights

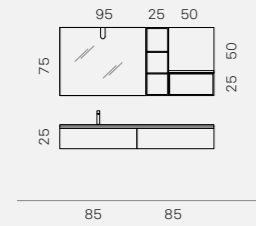

E.LY J 70 (page 40-41)
L 170 x P 51 cm

Integrato
Lavabo L 170 cm
in cristallo Taupe sp.1 cm

Base L. 170
Finitura **Rovere arlington**

Specchiera
filo lucido L 95 H 75 cm
con faretto Nite 800

Integrato
Washbasin W. 170 cm in Taupe
glass, 1 cm thick

Base unit W. 170
Finish **Rovere arlington**

Mirror
polished edge W. 95 H. 75 cm
with Nite 800 spotlight

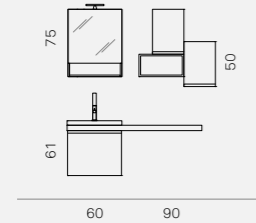

E.LY J 38 (page 46-47)
L 150 x P 51 cm + pensili

Lego 61
Lavabo consolle in mineralguss

Base L. 60
Finitura **Sherwood burn**
con particolari
Sherwood polvere

Top
Unicolor Cemento L 150 cm

Specchiera
Contenitore Cabrio
con faretto Filo

Lego 61
Console washbasin in Mineralguss

Base unit W. 60
Finish **Sherwood burn**
with details in
Sherwood polvere

Top
Unicolor Cemento W. 150 cm

Mirror
Cabrio storage unit
with Filo spotlight

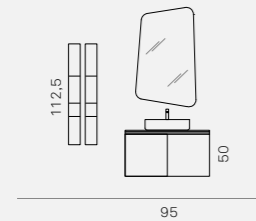

E.LY J 72 (page 48-49)
L 95 x P 51 cm

Nespola 45
lavabo in ceramica bianca
con top bianco opaco sp.1.8 cm

Base L. 95
Finitura **Cielo opaco**
con particolari Bianco e
Verde Twiggy opaco

Specchiera
Sghemba

Nespola 45
Washbasin In white ceramic with
matt white top, 1.8 cm thick

Base unit W. 95
Finish **Matt Cielo**
with details in Bianco
and matt Verde Twiggy

Mirror
Sghemba

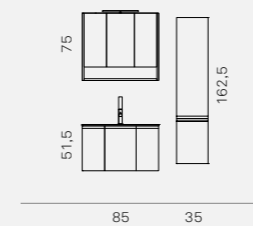

E.LY J 39 (page 52-53)
L 85 x P 51 cm + colonna - tall unit

Roxi 85
lavabo consolle in mineralguss

Base L. 85
Finitura **Sherwood platino**

Specchiera
Contenitore Cabrio
con faretto Flipper

Roxi 85
Console washbasin in Mineralguss

Base unit W. 85
Finish **Sherwood platino**

Mirror
Cabrio storage unit
with Flipper spotlight

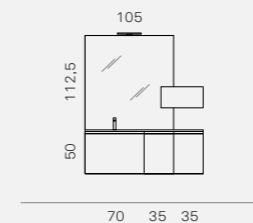

E.LY J 71 (page 54-55)
L 140 x P 38/51 cm

Integrato
lavabi L 140 cm in teknoril
7037 sp. 1.2 cm

Base L. 140
Finitura **Giallo Polline opaco**
con particolari cenere opaco

Specchiera
filo lucido L 70 H 112.5 cm
con faretto Spark

Integrato
Washbasin W. 140 cm in Teknoril
7037, 1.2 cm thick

Base unit W. 140
Finish **Matt Giallo Polline**
with details in matt Cenere

Mirror
polished edge W. 70 H. 112.5 cm
with Spark spotlight

Rovere

Oak



Arlington

Sherwood

+ 50 laccati opaco



Luna

Polvere

Platino

Burn

Olmo



Bianco

Grigio

Canapa

Marrone

Ares



50 solare

53 lunare

Colore laccato opaco e lucido

Matte and gloss lacquered color



Inox

Taupe

Nero

Grigio fumo di Londra

Cenere

Nebbia

Grigio Perla

Brezza



Bianco

New Pergamon

Ecrù

Juta

Canapa

Terranova

Brown

Cacao



Terra

Visone

Verde bosco

Verde oliva

Verde Twiggi

Verde salvia

The verde

Germoglio



Fiordaliso

Vaniglia

Giallo Polline

Arancio

Mattone

Rosso Fuoco

Bordeaux

Rosso India



Blu Night

Blu Marin

Navy

Petrolio

Cascata

Cielo

Acquamarina

Sky



Nuvola

Lavanda

Glicine

Rosa confetto

Lilla light

Bocciole

Geranio

Amarena



Lampone

Design e coordinamento: Arcom
Progetto Grafico: Lokomotiv
Foto: Indoor
Art direction photo and styling: Rossi & Co.
Fotolito: Luce
Stampa: OGM
Stampato: Ottobre 2017



By ARCOM srl

33070 Tamai di Brugnera (PN) Italy

Viale Europa 4

T. +39.0434.613619 / 1573020

F. +39.0434.608137

info@arcombagno.com

www.arcombagno.com



e-mail: gruppoatma@gruppoatma.it

<http://www.gruppoatma.it>

e.Ly

→
anta con maniglia
door with handle

ROVERE
LARICE
FRASSINO
YOSEMITE
NODO
ARES
OLMO
SHERWOOD
COLORE



e.Ly

→
anta con maniglia
door with handle

Un sistema di apertura tra i più diffusi:
la maniglia può essere decorativa,
nascosta o parte integrante del design,
in tutti i casi è molto pratica.

→
Aprire con la praticità
della maniglia

Open with a
practical handle

As one of the most
commonly used opening
mechanisms, handles
can be decorative, hidden
or an integral part of the
design; in all cases they
are very practical.

indice / index

-
- 04 → **Anta con maniglia**
Door with handle
 - 50 **Anta inclinata**
Angled door
 - 68 **Anta curva**
Curved door



Anta con maniglia

→
Door with handle

/ Con maniglia applicata o push-pull, l'apertura di ante e cassetti viene interpretata in diversi modi sull'arredobagno. Quando si vede la maniglia diventa anche un accessorio decorativo, quando non c'è prevale la pulizia estetica dei frontali. AK propone diversi modelli e finiture di maniglia da adattare al tipo di anta o di elemento per dare alla funzionalità un certo stile.

/ With an applied or push-pull handle, doors and drawers can be opened in different ways depending on how the furniture is interpreted. When on show, the handle is a decorative accessory; when hidden, the fronts have an ultra-clean look. K offers different models and finishes for its handles, adaptable to suit the type of door or unit, to add style to this functional element.



E.LY 60
maniglia - handle art.323

L 85 P 51 cm
photo

Drop
lavabo L. 85
in ceramica bianca
washbasin W. 85
in white ceramic



Base L. 85 / Base unit
finitura / finish
OLMO JEREZ GRIGIO

Specchiera / Mirror
Swing con faretto Penny
Swing with Penny spotlight

Colonna L. 35 / Tall unit
finitura / finish
Laccato Verde Bosco opaco
Matt lacquered Verde Bosco



**Allungata per la base, più piccola per la colonna:
ad ogni elemento la sua tipologia di maniglia
per unire funzionalità e stile.**

→
Trovare per ogni arredo
la maniglia perfetta

Find the right handle for
every style of furniture

Longer on the base units,
shorter on the tall units,
there is a handle for
every unit type, to merge
style and functionality.



E.LY 63
maniglia - handle Push-pull

L 210 P 51 cm
+ pensili / wall units
photo



Softly 60
L 60 x P 43 x H 17 cm
in ceramica bianca con top
invecchiato scuro sp.8 cm
in white ceramic with
dark aged top, 8 cm thick



Base L. 175 / Base unit
finitura / finish
ARES 53 LUNARE
con particolari Magma opaco
with matt Magma details

Specchiera / Mirror
L 50 x H 105 cm filo lucido
con faretto Aifon
filo lucido with Aifon spotlight



L'apertura push-pull mette in evidenza la finitura dell'anta e la geometria degli elementi. Su basi e pensili la maniglia c'è, ma non si vede.

The push-pull opening brings out the finish on the door and the shape of the units. The handle is there on the base and wall units, but you can't see it.

Softly 60

L 60 P 43 H 17 cm



finiture / finish
ceramica / ceramic

misure interno vasca /
internal basin size
L 57 P 30 H 14,5 cm



E.LY 64
maniglia - handle art.323

L 120 P 51 cm
photo

Integrato Jolly
in mineralguss sp.1.2 cm
in Mineralguss, 1.2 cm thick



Base L. 120 / Base unit
finitura / finish
OLMO JEREZ MARRONE
con particolari laccato Taupe
opaco - with details in matt
lacquered Taupe

Specchiera / Mirror
Ba-Bà con faretto **Ridley**
Ba-Bà with **Ridley** spotlight



Esaltare i contrasti materici
Bring out the texture

Il bianco assoluto del lavabo è abbinato alle venature scure dell'olmo, sulle quali risalta il cromato della maniglia. Una composizione equilibrata nei contrasti.

The pure white sink is paired with the dark elm grain. The chrome handle stands out against this backdrop. A balanced composition of contrasts.

→
Questione di dettagli
eleganti e raffinati



Integrato Jolly

L 120 P 51 sp.1 cm

finiture / finishes
Mineralguss bianco sp.1.2 cm
in Mineralguss, 1.2 cm thick

misure interno vasca /
internal basin size
L 60 P 35,5 H 12 cm

Finishes Laccato

E.LY 73
maniglia - handle art.370

L 170 P 51 cm
photo

Integrato
in teknoril bianco "pietra"
in "Pietra" white Teknoril



Base L. 170 / Base unit
finitura / finish
**LACCATO BIANCO E
CANAPA OPACO**

Specchiera / Mirror
Filo lucido L 95 H 75 cm
con faretto **Cremino**
Filo Lucido W. 95 H. 75 cm
with **Cremino** spotlight





→ Sottolineare il design
con la maniglia

La maniglia lungo l'anta
The handle along the door

La maniglia corre sul profilo superiore (o inferiore) dell'anta, a tutta lunghezza, lasciando invariata la pulizia estetica dei frontali.

The handle runs along the full length of the upper or lower profile of the door, leaving the clean line of the fronts untouched.



→
Aprire nuovi spazi
sulla parete

I pensili a giorno in legno sono integrati con ulteriori vani in metallo per organizzare lo spazio contenitivo e allo stesso tempo dare originalità agli elementi.

Open up new spaces
on the wall

The open-fronted wooden wall units have additional metal compartments, to organise the storage space and, at the same time, make the units original.



E.LY 74
maniglia - handle art.370

L 165 P 51 cm
photo

Dandy
L 64 P 35,5 H 4 cm
lavabo in ceramica
ceramic washbasin

Base L. 165 / Base unit
finitura / finish
LARICE BIANCO

Specchiera / Mirror
Tonda diametro 80 cm
con faretto Nite
Tonda mirror, 80 cm
diameter, with Nite spotlight





La sottile linea della maniglia cromata fa risaltare ulteriormente la luminosità del tutto bianco. La composizione è dinamica, ma anche essenziale.

The thin chrome handle intensifies the brightness of the all-white finish. This composition is simple yet dynamic.

→
Sfalsare le basi per dare
movimento

Dandy

L 64 P 35,5 H 4 cm

finiture / finish
ceramica / ceramic

misure interno vasca /
internal basin size
L 53 P 34 H 9 cm





E.LY 75
maniglia - handle art.370

L 175 P 51 cm
photo



Softly 60
L 60 x P 43 x H 17 cm
in ceramica bianca con
top Nodo Bianco sp.6 cm
in white ceramic with Nodo
Bianco top, 6 cm thick



Base L. 175 / Base unit
finitura / finish
NODO TALCO

Specchiera / Mirror
Tonda diametro 80 cm con luci led
Tonda 80 cm diameter,
with LED lights





→
Portare le venature
anche sul top



La versatilità delle venature
Versatile grains

Sulla base e sul top le venature si esprimono in due diverse tonalità e danno un aspetto naturale alla composizione.

On the base unit and top, the grain is in two different shades and gives the composition a natural look.

Decorare la parete con
mensole originali

Basi e top si abbinano ad altri elementi coordinati nelle finiture, ma unici nel design. Come le mensole in metallo con schiena abbinata all'arredo.

Decorate the wall with original shelving

Base units and tops match other units with the same finishes, but each design is unique. Just like the metal shelves, with a back panel to match the furniture.



E.LY 76
maniglia - handle art.163

L 95 P 51 cm
photo

Mery
L 55 x P 43 x H 5 cm
in mineralguss



Base L. 95 / Base unit
finitura / finish
FRASSINO BIANCO
con particolari Salvia opaco
with matt Salvia details

Specchiera / Mirror
filo lucido L 50 x H 105 cm
con faretto **Ridley**
Filo Lucido W. 50 x H. 105 cm
with **Ridley** spotlight

Specchiera **Tonda** diametro
80 cm con faretto **Ridley**
Tonda mirror, 80 cm diameter,
with **Ridley** spotlight



Sembrano uguali, ma sono i dettagli a fare la differenza: l'elemento a giorno integrato ad una delle due basi e gli specchi di forme diverse.

They look the same but it's the details that make the difference: the open unit built into one of the two base units and the different shaped mirrors.



Mery

L 55 P 43 H 5 cm

finiture / finish
in mineralguss

misure interno vasca /
internal basin size
L 50 P 28 H 10 cm

ak bathroom



La maniglia è applicata sulle basi e sui pensili e con la sua particolare forma dà un tocco decorativo all'arredobagno.

The handle is applied to the base units and wall units and its unusual shape adds a decorative touch to the bathroom furnishings.

E.LY 33
maniglia - handle art.271

L 140 P 38/53 cm
+ pensili / + wall units
photo

Integrato Kreo
teknoril bianco sp.1.2 cm
white Teknoril, 1.2 cm thick



Base L. 140 / Base unit
finitura / finish
ROVERE TRANCHÈ CANAPA

Specchiera / Mirror
L 50 H 95 cm filo Lucido
con faretto **Filo** -
with **Filo** spotlight





All'interno della specchiera
contenitore c'è spazio per tutte le
cose che devono essere tenute a
portata di mano senza essere in vista.

Inside the storage mirror unit,
there is room for everything you
need to hand but not on show.

E.LY 40
maniglia - handle art.323

L 155 P 38/51 cm
photo

Drop
L. 106 in ceramica / ceramic

Base L. 105 / Base unit
finitura / finish
SHERWOOD POLVERE

Specchiera / Mirror
L 60 H 75 cm
contenitore **Luce**
Luce storage unit



E.LY 22
maniglia - handle art.274

L 175 P 38/51 cm
photo

Lego 106
in mineralguss

Base L. 175 / Base unit
finitura / finish
MAGMA E AGATA OPACO

Specchiera / Mirror
Plane L 66.2 H 95 cm
con luci led perimetrali
Plane W, 66.2 H. 95 cm
with perimeter LED lights



→
Creare composizioni originali
sulla parete

E.LY 41
maniglia - handle art.323

L 105 P 51 cm
+ pensili / wall units

Roxi
L 106 in mineralguss



Base L. 105 / Base unit
finitura / finish
SHERWOOD PLATINO

Specchiera / Mirror
Plane L 66.2 H 95 cm
con luce led integrata
Plane W. 66.2 H. 95 cm
with built-in LED light





E.LY 34
maniglia - handle art.283

L 105 P 38 cm
+ pensili / wall units
photo

Integrato
rettangolare in cristallo
sabbato sp.1.5 cm
rectangular in sandblasted
glass, 1.5 cm thick



Base L. 105 / Base unit
finitura / finish
LARICE BIANCO

Specchiera / Mirror
Lybra L.60 H.80 cm

Disporre gli elementi creando
composizioni inedite

Gli elementi pensili si possono comporre sfruttando la modularità dei contenitori e degli elementi a giorno con altezze e larghezze diverse.

Arrange the units to create innovative compositions

Wall units can be arranged by taking advantage of the modular storage units and open units, with different heights and widths.



E.LY 03
maniglia - handle art.243

L 145 P 51 cm
photo



Fall
ceramica bianca con top
Bianco Lucido sp.1.8 cm
white ceramic with top
Gloss Bianco, 1.8 cm thick



Base L. 145 / Base unit
finitura / finish
BIANCO LUCIDO

Specchiera / Mirror
contenitore **Easy** con
faretti **Leggo - Easy** storage
unit with **Leggo** spotlight



E.LY 77

maniglia - handle Push-pull

L 180 P 51 cm
photo



Softly 60

L 60 x P 43 x H 17 cm
in ceramica bianca con top
Olmo marrone sp.1,8 cm
in white ceramic with top
Marrone elm, 1,8 cm thick



Base L. 180 / Base unit

finitura / finish

OLMO MARRONE

con particolari laccato

Mattone opaco

with matt lacquered

Mattone details

Specchiera / Mirror

Diagonal L 175 x H 50 cm





L'anta con taglio diagonale lascia intravedere un modulo a giorno colorato. Anche nell'arredobagno, venature e colore formano una coppia di grande effetto.

The door with a diagonal cut gives a glimpse of the coloured open unit inside. Wood grain and colour are a winning combination in the bathroom furniture too.

→
Alternare elementi
chiusi e aperti

**Chiusa o a giorno, la colonna stupisce
sempre per la sua capacità di contenimento
e la varietà di finiture e moduli
con cui è possibile personalizzarla.**

**Alternate open and
closed units**

Whether open or closed,
the tall unit is striking,
both for the storage
space it offers and the
variety of finishes and
units that can be used to
personalise it.



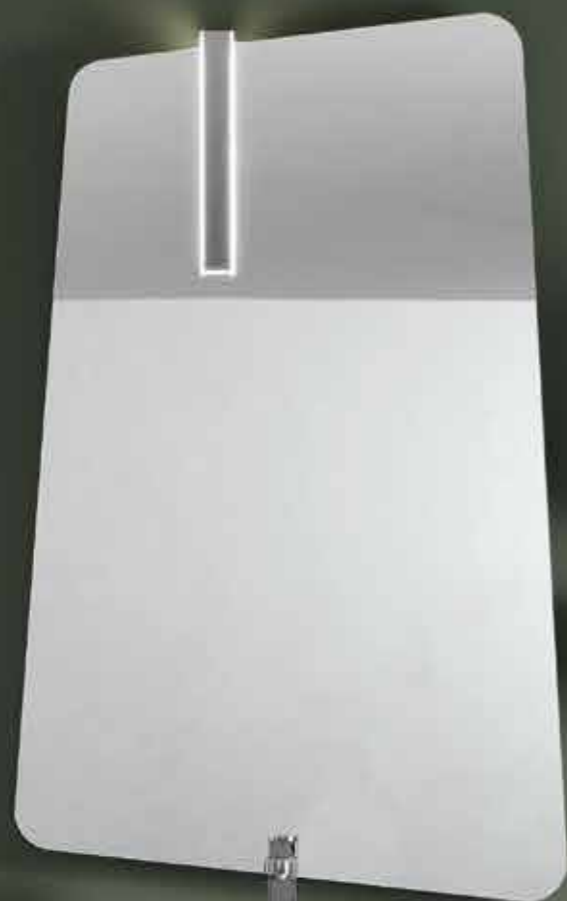

E.LY 78
maniglia - handle Push-pull

L 110 P 51 cm
photo

Giò
incasso soprapiano in
ceramica con top Ares 53
lunare sp.1,8 cm
recessed countertop in
ceramic with Ares 53 Lunare
top, 1.8 cm thick



Base L. 110 / Base unit
finitura / finish
ARES 53 LUNARE
particolari laccati
Verde Oliva opaco
lacquered details
Matt Verde Oliva

Specchiera / Mirror
Sghemba con faretto Ridley
Sghemba with Ridley spotlight





**Dare unicità all'ambiente
Unique touch to the space**

Le mensole in metallo con
schiene colorate possono
essere coordinate all'arredo o
al colore di fondo della parete.

The metal shelves with
coloured back panels can be
matched to the furniture or
the backdrop wall colour.

→
Rendere più originale la
funzionalità delle mensole





Il design obliquo dell'anta è il tratto distintivo della base: lascia parzialmente visibile il modulo a giorno e dà un carattere originale all'arredo.

The angled line of the door is the distinctive feature of the base unit. It leaves the open-fronted unit partially on show and gives additional character to the furniture.

E.LY 79
maniglia - handle Push-pull

L 120 P 51 cm
photo

City
lavabo consolle in mineralguss
vasca dx L 120 P 51 cm
console washbasin in Mineralguss, right sink



Base L. 120 / Base unit
finitura / finish
LACCATO BOCCIOLO
E CANAPA OPACO

Specchiera / Mirror
L 95 H 50 cm filo lucido
con faretto **Matisse** - Filo
Lucido with **Matisse** spotlight





E.LY 80

L 130 P 51 cm
photo

Fall
in ceramica con top cristallo
Fumo di Londra sp.1.5 cm
in ceramic with glass Fumo
di Londra top, 1.5 cm thick



Base L. 130 / Base unit
finitura / finish
LACCATO Platino e Grigio
fumo di Londra opaco / matt

Specchiera / Mirror
Plane L 66,2 H 95 cm



→
Abbinare più matericità in
un'unica composizione

Il taglio-dettaglio dell'anta
The cut detail on the door

Due ante oblique per dare alla base un taglio originale. Il design abbinato alle tonalità di grigio rendono moderna e attuale la composizione.

Two slanting doors to give the base unit an original angle. The design combined with different grey tones make the composition modern and current.



→ Mettere nuove
geometrie sulla parete

La mensola a zig-zag in metallo sta bene in qualsiasi ambiente della casa, anche sulla parete del bagno. La schiena colorata permette abbinamenti con l'arredo.

Add new patterns to the wall

A zigzag metal shelf sits well in any space in the home, including on the bathroom wall. The coloured back panel means it can be matched to the furniture.



E.LY 35
maniglia - handle art.323

L 195 P 20,8/51 cm
photo

Integrato Jolly
in mineralguss sp.1.2 cm



Base L. 195 / Base unit
finitura / finish
LARICE BICOLORE ECRÙ

Specchiera / Mirror
Orion Ø 90 cm



E.LY 26
maniglia - handle art.323

L 120 P 38/51 cm
photo

Integrato Jolly
in mineralguss sp.1.2 cm



Base L. 120 / Base unit
finitura / finish
BIANCO OPACO

Specchiera / Mirror
Orion Ø 90 cm



Nella forma arrotondata della base sospesa trovano spazio contenitori e vani a giorno e un top con lavabo integrato e una buona superficie d'appoggio. La specchiera contenitore ha un profilo di luci a led.

The round shape includes close and open units and a worktop with built-in washbasin and a wide surface. The mirror cupboard boasts led lights.

E.LY 20
maniglia - handle art.323

L 155 P 23,2/51 cm
photo

Integrato Jolly
in mineralguss sp.1.2 cm



Base L. 155 / Base unit
finitura / finish
YOSEMITE CHIARO

Specchiera / Mirror
Quantum L 95 cm
con luci led - with LED lights



→
Portare nuove geometrie
nell'arredo

E.LY 15
maniglia - handle art.323

L 114 P 38/51 cm
photo

Integrato Ovale
in cristallo canapa sp.1 cm
in Canapa glass, 1 cm thick



Base L. 114 / Base unit
finitura / finish
ROVERE TRANCHÈ CANAPA

Specchiera / Mirror
L 85 H 75 cm filo lucido
con faretto **Flipper** - Filo
Lucido with **Flipper** spotlight



Arredare con la morbidezza
delle curve

Un bagno moderno, attento alle esigenze del vivere contemporaneo, dove la qualità e lo stile convergono in un design morbido ma funzionale.

Furnish your space with soft curves

A modern bathroom, attentive to the needs of contemporary living, where quality and style come together to create a soft but functional design.



E.LY 06
maniglia - handle art.323

L 130 P 51/38 cm
photo

Fusion L 95
in mineralguss sp. 3.5 cm



Base L. 130 / Base unit / Top
finitura / finish
GRIGIO ANTRACITE LUCIDO

Specchiera / Mirror
L 120 H 50 cm filo lucido
con faretto **Flipper** - Filo
Lucido with **Flipper** spotlight

ak bathroom

77 e.Ly collection



Moduli per interpretare ogni esigenza, soluzioni per arredare creando ambienti funzionali. Ogni composizione nasce per ottimizzare lo spazio a disposizione inventando uno stile sempre personale.

Modules to meet all requirements, solutions to furnish whilst creating functional settings. Every element is born to optimise the available space, while devising a style which is always personal.

E.LY 31
maniglia - handle art.283

L 120 P 38/51 cm
photo

Integrato ovale
in teknorit sp.1.2 cm



Base L. 120 / Base unit
finitura / finish
BIANCO OPACO

Specchiera / Mirror
L 70 x H 112.5 cm filo lucido
con faretto **Regolo** - Filo
Lucido with **Regolo** spotlight





Lo specchio illumina la base completa di piano e lavabo integrato, grazie all'inserimento funzionale e decorativo dei led.

The mirror lights up the base complete with top and built-in washbasin using leds to achieve both functional and decorative lighting.

E.LY 28/B
maniglia - handle art.283

L 105 P 38/51 cm
photo

Integrato Duna
in mineralguss sp.1.2 cm



Base L. 105 / Base unit
finitura / finish
AGATA LUCIDO

Specchiera / Mirror
Lybra L 60 H 80 cm



E.LY 81
maniglia - handle art.323

L 95 P 51 cm
photo

Integrato
in teknoril grigio 7004



Base L. 95 / Base unit
finitura / finish
ROVERE ARLINGTON
cenere opaco - matt Cenere

Specchiera / Mirror
Filo lucido L 70 H 50 cm
con faretto Aalto
Filo Lucido mirror W. 70 H. 50
cm with Aalto spotlight



Il lato moderno
della natura

Lo stile naturale dell'arredobagno è reso più attuale dalla finitura del top e della maniglia cromata. Un design lineare che arreda con semplicità grandi e piccoli spazi.

The modern side
of nature

The natural style of this bathroom furniture is made more current with the top finish and chrome handle. This linear design creates simple furniture for spaces large and small.



Finishes NODO

E.LY 82
maniglia - handle art.163

L 85 P 51 cm
photo

Integrato
in cristallo Grigio perla
Sp.1.5 cm



Base L. 85 / Base unit
finitura / finish
NODO TABACCO

Colonna / Column
L.25 x P.20.8 cm
in ares 53 lunare

Specchiera / Mirror
Filo lucido L.85 H.75 cm





La lucentezza del piano in cristallo si abbina alle venature della base: chiaroscuri e contrasti creano una composizione in armonia con sé stessa e con l'ambiente.

The gleaming glass top combines with the grain on the base unit to create a contrasting chiaroscuro effect that fits harmoniously into the composition.

→ Dare risalto alle venature con il cristallo



Faretto Ufo

finiture / finish
bianco opaco / matt white





La base a terra arreda spazi contenuti, ma il pensile abbinato aumenta lo spazio di contenimento. Pochi elementi per un ambiente bagno che punta all'essenzialità.

The floor-standing base unit furnishes smaller spaces, and the matching wall unit provides even more storage space. A few, well-placed elements create a sleek and simple bathroom space.

E.LY 83
maniglia - handle art. 163

L 70 P 51 cm
photo

Roxi
lavabo consolle in mineralguss
console washbasin in Mineralguss



Base L. 70 / Base unit
finitura / finish
LARICE BICOLORE CANAPA
e laccato terra opaco

Specchiera / Mirror
L 50 H 105 cm Filo lucido
con faretto **Filo** - Filo Lucido
with **Filo** spotlight





Capiente ed estremamente funzionale, l'arredobagno contiene in un'unica base tutto il necessario. Un'ottima soluzione salvaspazio con finiture di tendenza e la praticità della maniglia.

The bathroom furniture offers everything you need in terms of space and function in just one base unit. An excellent space-saving solution with on-trend finishes and a practical handle.

E.LY 67
maniglia - handle art.163

L 120 P 51 cm
photo

Giò
incasso soprapiano in
ceramica bianca con top
unicolor stratificato (HPL)
Linosa sp.1 cm
recessed countertop in white
ceramic with HPL Linosa
Unicolor top, 1 cm thick

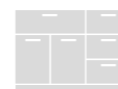

Base L. 120 / Base unit
finitura / finish
OLMO JEREZ GRIGIO
Specchiera / Mirror
filo lucido L 120 H 75 cm



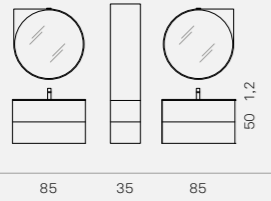

E.LY 60 (page 06-07)
L 85 x P 51 cm
maniglia - handle art.323

Drop
Lavabo L. 85
in ceramica bianca

Base L. 85
Finitura **Olmo jerez grigio**

Specchiera
Swing con **faretto Penny**

Drop
Washbasin W. 85
in white ceramic

Base unit W. 85
Finish **Jerez grigio elm**

Mirror
Swing with Penny **spotlight**

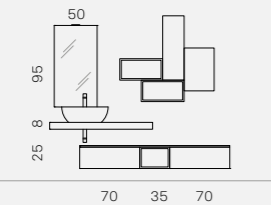

E.LY 63 (page 10-11)
L 210 x P 51 cm + pensili - wall unit
maniglia - handle Push-pull

Softly
Lavabo L 60 x P 43 x H 17 cm
in ceramica bianca con top
invecchiato scuro sp.8 cm

Base L. 175
Finitura **Ares 53 lunare**
con particolari **Magma opaco**

Specchiera
Filo lucido L 50 x H 105 cm
con **faretto Aifon**

Softly
Washbasin W. 60 x D. 43 x H. 17 cm
in white ceramic with
dark aged top, 8 cm thick

Base unit W. 175
Finish **Ares 53 lunare**
with matt **Magma details**

Mirror
Filo Lucido W. 50 x H. 105 cm
with **Aifon spotlight**

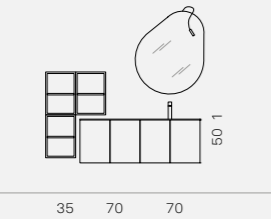

E.LY 64 (page 14-15)
L 120 x P 51 cm
maniglia - handle art.323

Integrato Jolly
Lavabo in mineralguss
sp.1.2 cm

Base L. 120
Finitura **Olmo jerez marrone**
con particolari laccato
Taupe opaco

Specchiera
Ba-Bà con **faretto Ridley**

Integrated Jolly
Washbasins in Mineralguss,
1.2 cm thick

Base unit W. 120
Finish **Jerez marrone elm**
with details in matt
lacquered **Taupe**

Mirror
Ba-Bà with **Ridley spotlight**

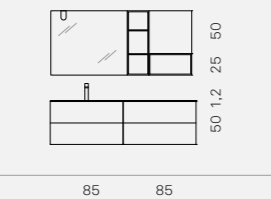

E.LY 73 (page 18-19)
L 170 x P 51 cm
maniglia - handle art.370

Integrato
lavabo in teknoril
bianco "pietra"

Base L. 170
Finitura **Laccato bianco**
e **canapa opaco**

Specchiera
Filo lucido L 95 H 75 cm
con **faretto Cremino**

Integrated
Washbasin in "Pietra"
white Teknoril

Base unit W. 170
Finish **Lacquered bianco**
and **matt canapa**

Mirror
Filo Lucido W. 95 H. 75 cm
with **Cremino spotlight**

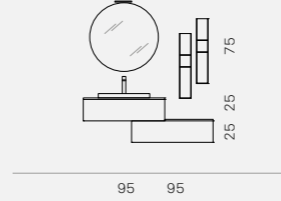

E.LY 74 (page 24-25)
L 165 x P 51 cm
maniglia - handle art.370

Dandy
Lavabo in ceramica
L 64 P 35.5 H 4 cm

Base L. 165
Finitura **Larice bianco**

Specchiera
Tonda diametro 80 cm
con **faretto Nite**

Dandy
Washbasin ceramic
W. 64 D. 35.5 H. 4 cm

Base unit W. 165
Finish **Bianco larch**

Mirror
Tonda mirror, 80 cm diameter,
with **Nite spotlight**

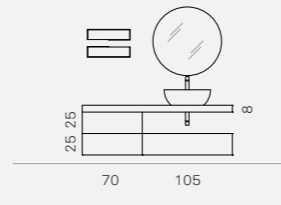

E.LY 75 (page 28-29)
L 175 x P 51 cm
maniglia - handle art.370

Softly
Lavabo L 60 x P 43 x H 17 cm
in ceramica bianca con
top **Nodo Bianco** sp.6 cm

Base L. 175
Finitura **Nodo talco**

Specchiera
Tonda diametro 80
con luci led

Softly
Washbasin W. 60 x D. 43 x H. 17 cm
in white ceramic with **Nodo Bianco**
top, 6 cm thick

Base unit W. 175
Finish **Nodo talco**

Mirror
Tonda, 80 cm diameter,
with **LED lights**

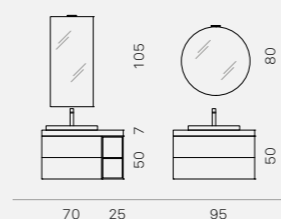

E.LY 76 (page 34-35)
L 95 x P 51 cm
maniglia - handle art.163

Mery
Lavabo L 55 x P 43 x H 5 cm
in mineralguss

Base L. 95
Finitura **Frassino bianco**
con particolari **Salvia opaco**

Specchiera
filo lucido L 50 x H 105 cm
con **faretto Ridley**
Tonda diametro 80 cm
con **faretto Ridley**

Mery
Washbasins W. 55 x D. 43 x H. 5 cm
in Mineralguss

Base unit W. 95
Finish **Bianco ash**
with matt **Salvia details**

Mirror
Filo Lucido W. 50 x H. 105 cm
with **Ridley spotlight**
Tonda mirror, 80 cm diameter,
with **Ridley spotlight**

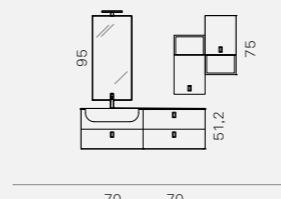

E.LY 33 (page 38-39)
L 140 x P 38/53 cm + pensili - wall unit
maniglia - handle art.271

Integrato Kreo
lavabo in teknoril
bianco sp.1.2 cm

Base L. 140
Finitura
Rovere tranchè canapa

Specchiera
Filo Lucido L 50 H 95 cm
con **faretto Filo**

Integrated Kreo
Washbasin white Teknoril,
1.2 cm thick

Base unit W. 140
Finish
Canapa tranchè oak

Mirror
Filo Lucido W. 50 H. 95 cm
with **Filo spotlight**

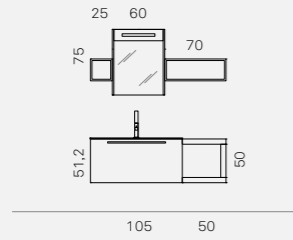

E.LY 40 (page 40-41)
L 155 x P 38/51 cm
maniglia - handle art.323

Drop
Lavabo L. 106
in ceramica

Base L. 105
Finitura **Sherwood polvere**

Specchiera
L 60 H 75 cm
contenitore Luce

Drop
Washbasin W. 106
in ceramic

Base unit W. 105
Finish **Sherwood polvere**

Mirror
W. 60 H. 75 cm
Luce storage unit

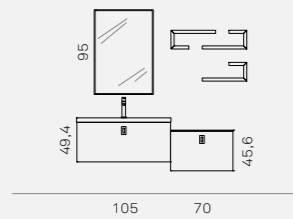

E.LY 22 (page 42-43)
L 175 x P 38/51 cm
maniglia - handle art.274

Lego
Lavabo L. 106 in mineralguss

Base L. 175
Finitura **magma e agata opaco**

Specchiera
Plane L 66.2 H 95 cm
con luci led perimetrali

Lego
Washbasin W. 106 in Mineralguss

Base unit
Finish **matt magma and agata**

Mirror
Plane W. 66.2 H. 95 cm
with perimeter LED lights



E.LY 41 (page 44-45)
L 105 x P 51 cm + pensili - wall unit
maniglia - handle art.323

Roxi
Lavabo L. 106
in mineralguss

Base L. 105
Finitura **Sherwood platino**

Specchiera
Plane L 66.2 H 95 cm
con luce led integrata

Roxi
Washbasins W. 106
in Mineralguss

Base unit W. 105
Finish **Sherwood platino**

Mirror
Plane W. 66.2 H. 95 cm
with built-in LED light

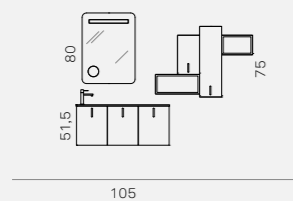

E.LY 34 (page 46-47)
L 105 x P 38 cm + pensili - wall unit
maniglia - handle art.283

Integrato
lavabo rettangolare in
cristallo sabbaiato sp.1.5 cm

Base L. 105
Finitura **Larice bianco**

Specchiera
Lybra L 60 H 80 cm

Integrated
Washbasin rectangular in
sandblasted glass, 1.5 cm thick

Base unit W. 105
Finish **Bianco larch**

Mirror
Lybra W. 60 H. 80 cm

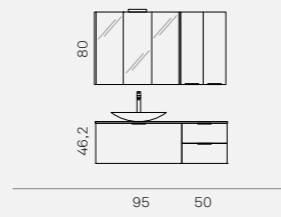

E.LY 03 (page 48-49)
L 145 x P 51 cm
maniglia - handle art.243

Fall
Lavabo ceramica bianca
con top Bianco Lucido
sp.1.8 cm

Base L. 145
Finitura **Bianco lucido**

Specchiera
contenitore Easy
con **faretto** Lego

Fall
Washbasin white ceramic
with top Gloss Bianco,
1.8 cm thick

Base unit W. 145
Finish **Gloss bianco**

Mirror
Easy storage unit with
Lego **spotlight**

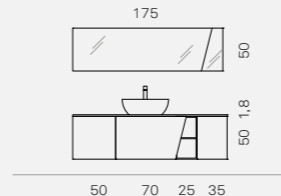

E.LY 77 (page 50-51)
L 180 x P 51 cm
maniglia - handle Push-pull

Softly
Lavabo L 60 x P 43 x H 17 cm
in ceramica bianca con top
Olmo marrone sp.1.8 cm

Base L. 180
Finitura **Olmo marrone**
con particolari laccato
Mattone opaco

Specchiera
Diagonal L 175 x H 50 cm

Softly
Washbasin W. 60 x D. 43 x H. 17 cm
in white ceramic with top
Marrone elm, 1.8 cm thick

Base unit W. 180
Finish **Marrone elm**
with matt lacquered
Mattone details

Mirror
Diagonal W. 175 x H. 50 cm

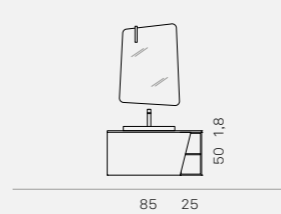

E.LY 78 (page 56-57)
L 110 x P 51 cm
maniglia - handle Push-pull

Giò
Lavabo incasso sopra piano
in ceramica con top
Ares 53 lunare sp.1.8 cm

Base L. 110
Finitura **Ares 53 lunare**
particolari laccati
Verde Oliva opaco

Specchiera
Sghemba con **faretto** Ridley

Giò
Washbasins recessed countertop
in ceramic with Ares 53 Lunare
top, 1.8 cm thick

Base unit W. 110
Finish **Ares 53 lunare**
lacquered details
Matt Verde Oliva

Mirror
Sghemba with Ridley **spotlight**

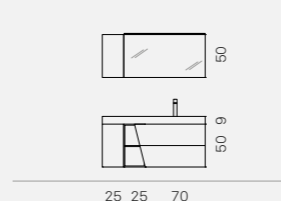

E.LY 79 (page 60-61)
L 120 x P 51 cm
maniglia - handle Push-pull

City
lavabo consolle
in mineralguss vasca dx
L 120 P 51 cm

Base L. 120
Finitura **Laccato bocciolo**
e canapa opaco

Specchiera
L 95 H 50 cm filo lucido
con **faretto** Matisse

City
Console washbasin
in Mineralguss, right sink
W. 120 D. 51 cm

Base unit W. 120
Finish **Lacquered bocciolo**
and matt canapa

Mirror
Filo Lucido W. 95 H. 50 cm
with Matisse spotlight

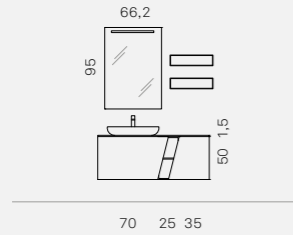

E.LY 80 (page 61-63)
L 130 x P 51 cm
maniglia - handle push-pull

Fall
Lavabo in ceramica
con top cristallo Fumo
di Londra sp.1.5 cm

Base L. 130
Finitura **Laccato platino**
e **grigio fumo di Londra opaco**

Specchiera
Plane L 66,2 H 95 cm

Fall
Washbasin in ceramic
with glass Fumo di Londra top,
1.5 cm thick

Base unit W. 130
Finish **Lacquered Platino**
and **mat Grigio Fumo di Londra**

Mirror
Plane W. 66.2 H. 95 cm

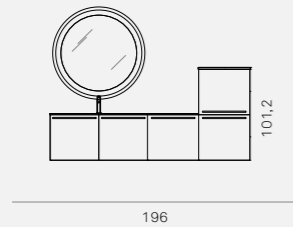

E.LY 35 (page 68-69)
L 195 x P 20,8/51 cm
maniglia - handle art.323

Integrato Jolly
Lavabo in mineralguss
sp.1.2 cm

Base L. 195
Finitura **Larice bicolore ecrù**

Specchiera
Orion, diametro 90 cm

Integrated Jolly
Washbasin in Mineralguss,
1.2 cm thick

Base unit W. 195
Finish **Two-tone ecrù larch**

Mirror
Orion, 90 cm diameter

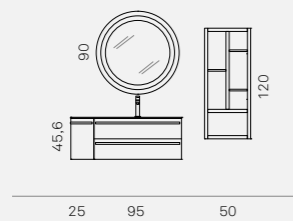

E.LY 26 (page 70-71)
L 120 x P 38/51 cm
maniglia - handle art.323

Integrato Jolly
Lavabo in mineralguss
sp.1.2 cm

Base L. 120
Finitura **Bianco opaco**

Specchiera
Orion diametro 90 cm

Integrated Jolly
Washbasins in Mineralguss,
1.2 cm thick

Base unit W. 120
Finish **mat bianco**

Mirror
Orion, 90 cm diameter

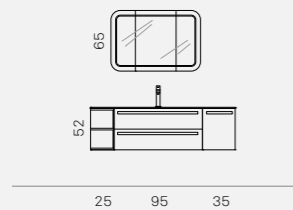

E.LY 20 (page 72-73)
L 155 x P 23,2/51 cm
maniglia - handle art.323

Integrato Jolly
lavabo in mineralguss
sp.1.2 cm

Base L. 155
Finitura **Yosemite chiaro**

Specchiera
Quantum L 95 cm con luci led

Integrated Jolly
Washbasin in Mineralguss,
1.2 cm thick

Base unit W. 155
Finish **light yosemite**

Mirror
Quantum W. 95 cm with LED lights

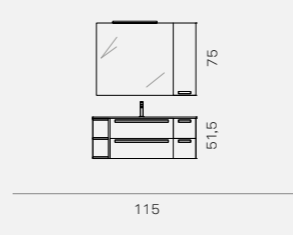

E.LY 15 (page 74-75)
L 114 x P 38/51 cm
maniglia - handle art.323

Integrato Ovale
Lavabo in cristallo
canapa sp.1 cm

Base L. 114
Finitura
Rovere tranchè canapa

Specchiera
L 85 H 75 cm filo lucido
con **faretto Flipper**

Integrated Ovale
Washbasin in Canapa glass,
1 cm thick

Base unit W. 114
Finish
canapa tranchè oak

Mirror
Filo Lucido W. 85 H. 75 cm
with Flipper **spotlight**

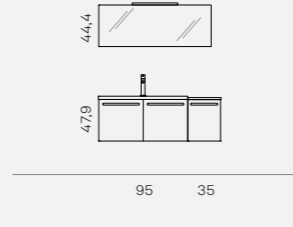

E.LY 06 (page 76-77)
L 130 x P 51/38 cm
maniglia - handle art.323

Fusion L 95
Lavabo in mineralguss
sp. 3.5 cm

Base e Top L. 130
Finitura **Grigio**
antracite lucido

Specchiera
filo lucido L 120 H 50 cm
con **faretto Flipper**

Fusion L 95
Washbasin in Mineralguss,
3.5 cm thick

Base unit and Top W. 130
Finish **gloss**
grigio antracite

Mirror
Filo Lucido W. 120 H. 50 cm
with Flipper **spotlight**

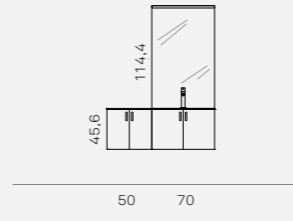

E.LY 31 (page 78-79)
L 120 x P 38/51 cm
maniglia - handle art.283

Integrato ovale
Lavabo in teknoril sp.1.2 cm

Base L. 120
Finitura **Bianco opaco**

Specchiera
filo lucido L 70 x H 112.5 cm
con **faretto Regolo**

Integrated Ovale
Washbasins in Teknoril, 1.2 cm thick

Base unit W. 120
Finish **mat bianco**

Mirror
Filo Lucido W. 70 x H. 112.5 cm
with Regolo **spotlight**

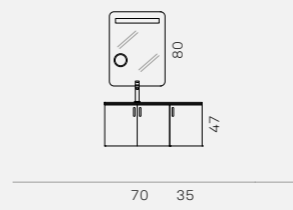

E.LY 28/B (page 80-81)
L 105 x P 38/51 cm
maniglia - handle art.283

Integrato Duna
lavabo in mineralguss
sp.1.2 cm

Base L. 105
Finitura **Agata lucido**

Specchiera
Lybra L 60 H 80 cm

Integrated Duna
Washbasin in Mineralguss,
1.2 cm thick

Base unit W. 105
Finish **Gloss Agata**

Mirror
Lybra W. 60 H. 80 cm

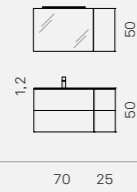

E.LY 81 (page 82-83)
L 95 x P 51 cm
maniglia - handle art.323

Integrato
Lavabo in teknoril
grigio 7004

Base L. 95
Finitura **Rovere Arlington**
e cenere opaco

Specchiera
Filo lucido L 70 H 50 cm
con **faretto** Aalto

Integrato
Washbasin in Grigio
Teknoril 7004

Base unit W. 95
Finish **Arlington oak**
and matt **Cenere** finish

Mirror
Filo Lucido mirror W. 70 H. 50 cm
with Aalto **spotlight**

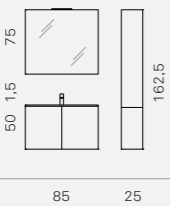

E.LY 82 (page 86-87)
L 85 x P 51 cm
maniglia - handle art.163

Integrato
Lavabo in cristallo
Grigio perla Sp.1.5 cm

Base L. 85
Finitura **Nodo tabacco**

Specchiera
Filo lucido
L 85 H 75 cm

Integrato
Washbasin in Grigio Perla glass,
1.5 cm thick

Base unit W. 85
Finish **Nodo tabacco**

Mirror
Filo Lucido
W. 85 H. 75 cm

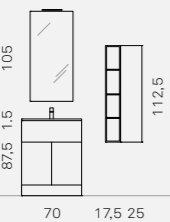

E.LY 83 (page 90-91)
L 70 x P 51 cm
maniglia - handle art. 163

Roxi
Lavabo consolle
in mineralguss

Base L. 70
Finitura **Larice bicolore**
canapa e laccato terra opaco

Specchiera
Filo lucido L 50 H 105 cm
con **faretto** Filo

Susina
Console washbasin
in Mineralguss

Base unit W. 70
Finish **two-tone Canapa larch**
finish and lacquered matt **Terra**

Mirror
Filo Lucido mirror W. 50 H. 105 cm
with Filo **spotlight**

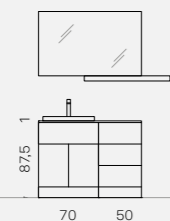

E.LY 67 (page 92-93)
L 120 x P 51 cm
maniglia - handle art.163

Giò
lavabo incasso sopra piano
in ceramica bianca con
top unicolor stratificato (HPL)
Linosa sp.1 cm

Base L. 120
Finitura **Olmo jerez grigio**

Specchiera
Filo lucido L 120 H 75 cm

Giò
Washbasin recessed countertop
in white ceramic with HPL
Linosa Unicolor top,
1 cm thick

Base unit W. 120
Finish **Jerez grigio elm**

Mirror
Filo Lucido W. 120 H. 75 cm

Maniglie in metallo

Metal handles



Art. 243
finitura / finish: Brill



Art. 271
finitura / finish: Bianco

Art. 273
finitura / finish: Cromo



Art. 163
finitura / finish: Cromo

Art. 165
finitura / finish: Alluminio



Art. 263
finitura / finish: Cromo



Art. 323
finitura / finish: Cromo



Art. 283
finitura / finish: Cromo



Art. 370
finitura / finish: Brill
Anta dritta / Straight door: L 25-35-50-60-70-85-95-105-120
No disponibile per le ante curve / Not available for curved doors

Larice

Larch



Bianco

Ecrù

Canapa

Frassino

Ash



Bianco

Yosemite

Yosemite



Chiaro

Rovere

Oak



Ecrù

Canapa

Marrone

Rovere

Oak



Arlington

Nodo



Bianco

Avorio

Talco

Tabacco

+ 50 laccati opaco

Sherwood



Luna

Polvere

Platino

Burn

+ 50 laccati opaco

Olmo



Bianco

Grigio

Canapa

Marrone

Ares



50 solare

53 lunare

Colore

Colour



Bianco opaco / lucido

Agata opaco / lucido

Magma opaco / lucido

Grigio antracite opaco / lucido

Colore laccato opaco e lucido

Matte and gloss lacquered color



Inox

Taupe

Nero

Grigio fumo di Londra

Cenere

Nebbia

Grigio Perla

Brezza



Bianco

New Pergamon

Ecrù

Juta

Canapa

Terranova

Brown

Cacao



Terra

Visone

Verde bosco

Verde oliva

Verde Twigg

Verde salvia

The verde

Germoglio



Fiordaliso

Vaniglia

Giallo Polline

Arancio

Mattone

Rosso Fuoco

Bordeaux

Rosso India



Blu Night

Blu Marin

Navy

Petrolio

Cascata

Cielo

Acquamarina

Sky



Nuvola

Lavanda

Glicine

Rosa confetto

Lilla light

Bocciole

Geranio

Amarena



Lampone



Platino*
Laccato opaco / Matt lacquer

Design e coordinamento: Arcom
Progetto Grafico: Lokomotiv
Foto: Indoor
Art direction photo and styling: Rossi & Co.
Fotolito: Luce
Stampa: Sincromia
Stampato: Gennaio 2018



By ARCOM srl

33070 Tamai di Brugnera (PN) Italy

Viale Europa 4

T. +39.0434.613619 / 1573020

F. +39.0434.608137

info@arcombagno.com

www.arcombagno.com



e-mail: gruppoatma@gruppoatma.it

<http://www.gruppoatma.it>

THE
NEW
CONCEPT
OF
LAUNDRY

W&D

Wash'n'dry

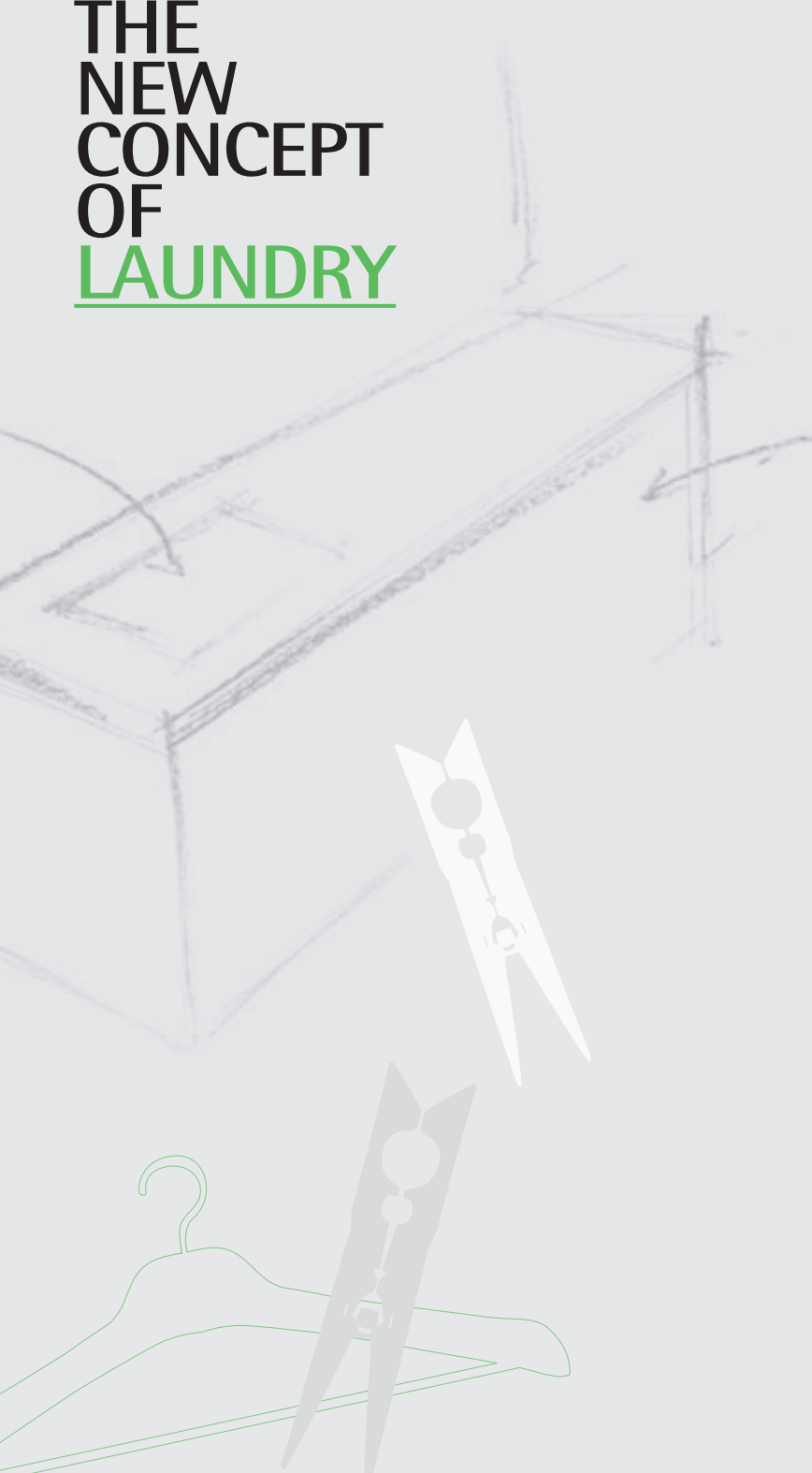

AK
BATHROOM

LA LAVANDERIA
SFOGGIA UNA
COLLEZIONE DI
ELEMENTI
FUNZIONALI
E VERSATILI,
DALL'ESTETICA
DINAMICA E
ACCATTIVANTE

THE LAUNDRY ROOM
BOASTS A COLLECTION OF
FUNCTIONAL AND VERSATILE
ELEMENTS, WITH DYNAMIC AND
CAPTIVATING AESTHETICS

W&D

Wash'n'dry



*lavabo incasso
soprapiano*

ante

*top al metro
lineare*

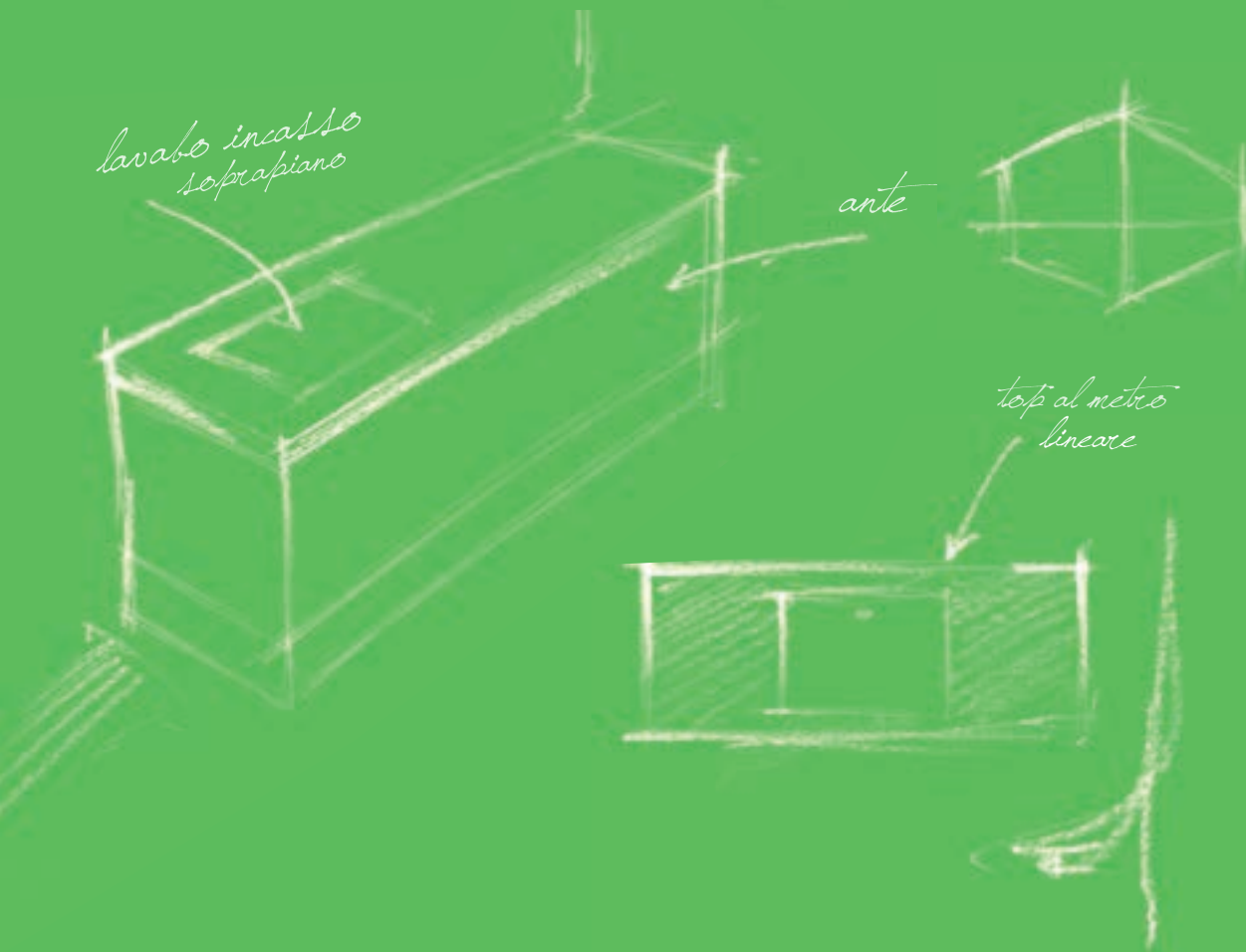



W&D
Wash'n'dry



3 tipologie di lavabo

CERAMICA
TEKNORIL
MINERALGUSS

3 wash basin types:
ceramic, teknoril, mineralguss

top sp 1,2 - 1,8 - 6 cm

Tops with sp 1,2 - 1,8 - 6 cm

dimensioni

A MISURA

Customised sizes

elementi funzionali
ED ERGONOMICI

Functional and ergonomic elements

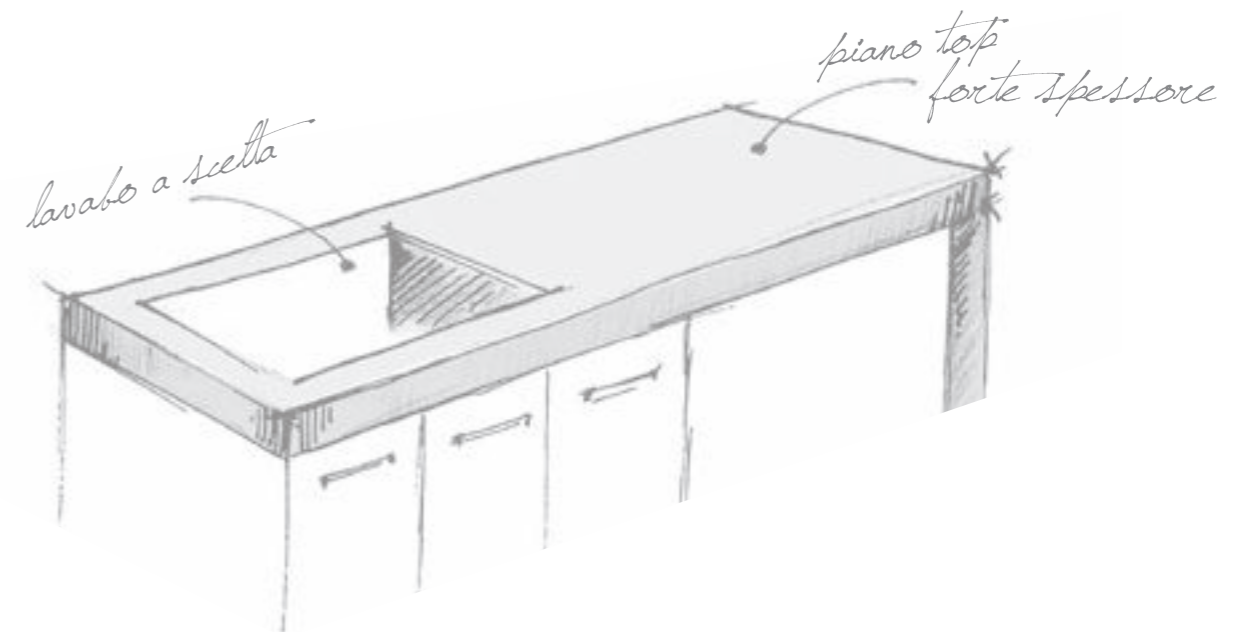



lavabo in CERAMICA / ceramic wash basin



LAVABO BALNEA

Lavabo in ceramica bianca
L 59 - P 34,5 - H 35 cm (interno vasca)



Un piano struttura in Unicolor Bianco Dax spesso 6 cm definisce la composizione. Il lavatoio in ceramica da incasso soprapiano, con incavo portasapone lavorato a rilievo e miscelatore decentrato, è illuminato dal faretto sottopensile a led.

A 6 cm thick Unicolor White Dax surface structure defines the composition. The built-in counter top ceramic wash tub, with grooved, relief soap-holder and off-centre tap, is illuminated by the LED under-unit spotlight.

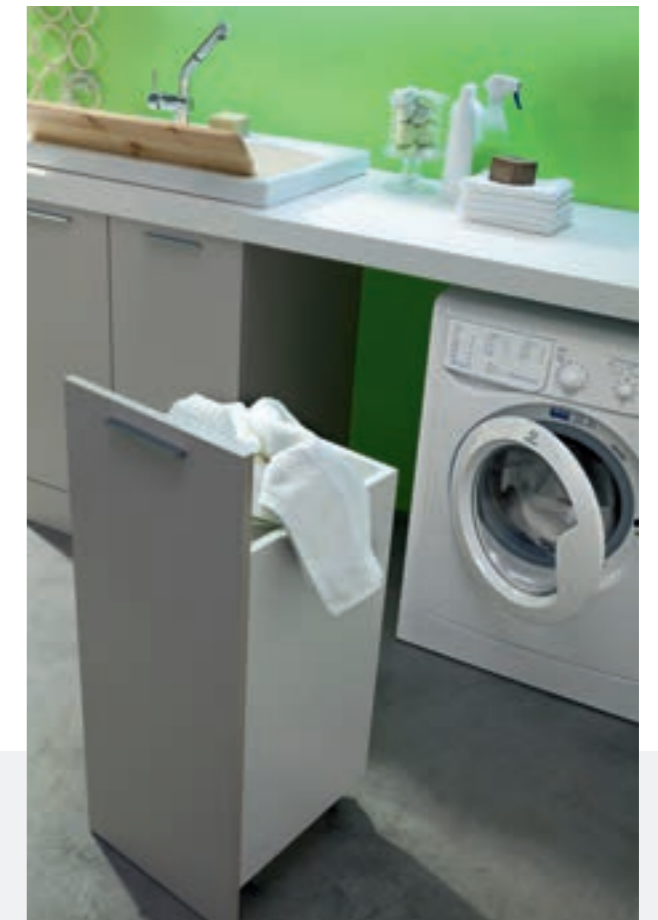

Il carrello portabiancheria, inserito tra contenitori e lavatrice, si sposta su ruote per un utilizzo più comodo e veloce.

The laundry trolley, inserted between the storage units and washing machine, can be wheeled making it more convenient and more readily available.

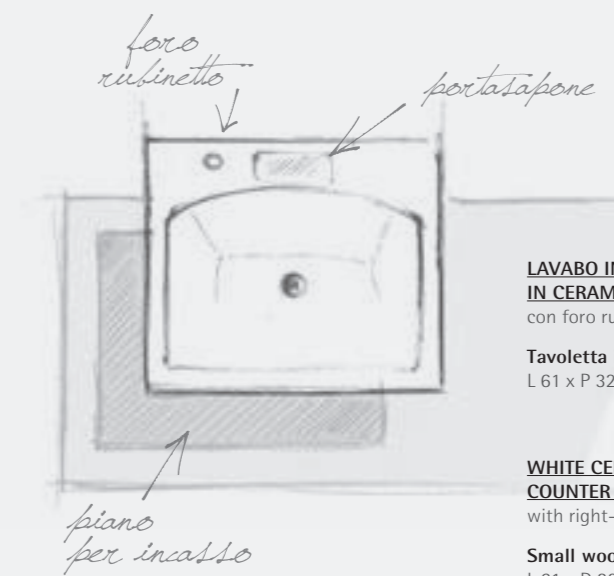

**LAVABO INCASSO SOPRAPIANO
IN CERAMICA BIANCA**
con foro rubinetto dx-sx

Tavoletta in legno (a richiesta)
L 61 x P 32 cm

**WHITE CERAMIC BUILT-IN
COUNTER TOP WASH BASIN**
with right-left tap hole

Small wooden board (upon request)
L 61 x D 32 cm



lavabo in CERAMICA / ceramic wash basin

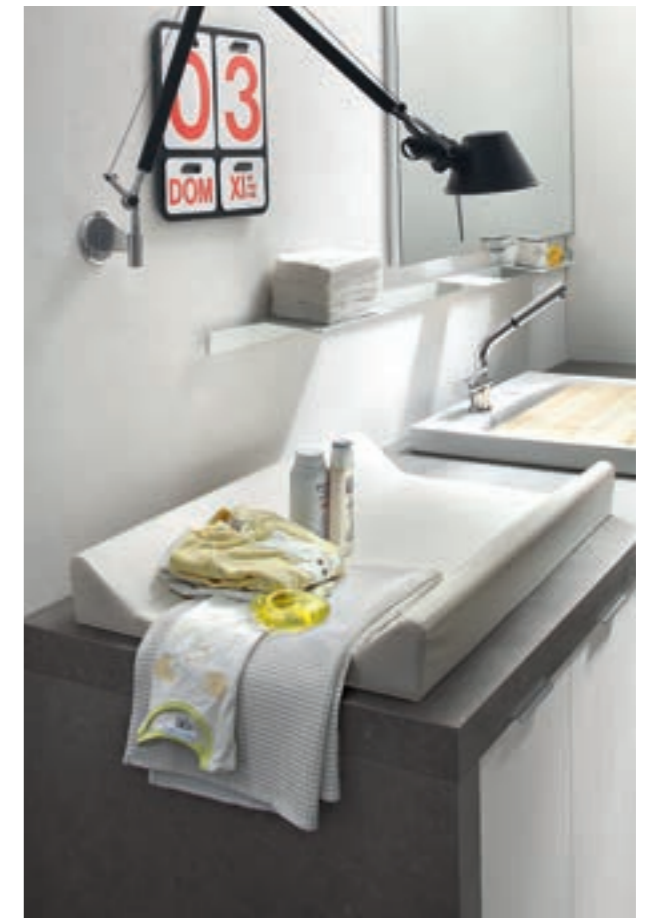

top 6cm

3 Profondità



TOP CON FORTE SPESSORE

Disponibile con spessore da 1,2/1,8/6 cm
 Profondità 38/51/63 cm
 Lunghezza massima da 210/250 cm

Il frassino bianco è abbinato all'Unicolor Cemento del fianco e del piano, dove c'è spazio anche per il fasciatoio. La base è completa di modulo porta lavabo e porta lavatrice a due ante.

The white ash is paired with the Unicolor Cemento of the side and top, where there is also room for a changing table. The base is completed with a wash basin support module and two-door washing machine front.

TOP 1,2 cm
 solo in teknoril e teknorit

TOP 1,8 cm
 tutte le finiture disponibili (larice, rovere, frassino...)

TOP 6 cm
 solo in UNICOLOR nei colori: Bianco Dax, Cemento, Grigio venato, Porfido, Cesar Brown

TOP 1,2 cm
 only in teknoril and teknorit

TOP 1,8 cm
 all finishes available (larch, oak, ash...)

TOP 6 cm
 only in UNICOLOR in the following colours: White Dax, Cemento, Grigio venato, Porfido, Cesar Brown





CARRELLO ESTRAIBILE ACCESSORIATO

L 50 - P 50 - H 87 cm



Una soluzione salva spazio ricca di funzionalità. Il carrello su ruote è un'idea dinamica che unisce un cesto portabiancheria a ribalta, un vano superiore portaoggetti e gli accessori posteriori per i detersivi e i saponi. Da usare come si vuole, dove si vuole.

A space-saving solution, bursting with functions. The wheeled trolley represents a dynamic idea which fuses a flap laundry basket, a top compartment for storing objects and further accessories for detergents and soaps. To be used liberally, whenever you wish.



Il carrello è perfettamente inserito nella base, con la stessa anta e maniglia.

The trolley fits perfectly into the base which displays a matching door and handle.



Si estrae per accedere al vano porta oggetti superiore.

It is extracted in order to access the top object storage compartment.



L'anta a ribalta consente in ogni momento l'uso del portabiancheria.

The flap door enables the use of the laundry basket at any given time.



Libero e indipendente, si sposta all'occorrenza dove più serve.

Unrestricted and independent, it can be moved to wherever it is needed.



lavabo in CERAMICA / ceramic wash basin

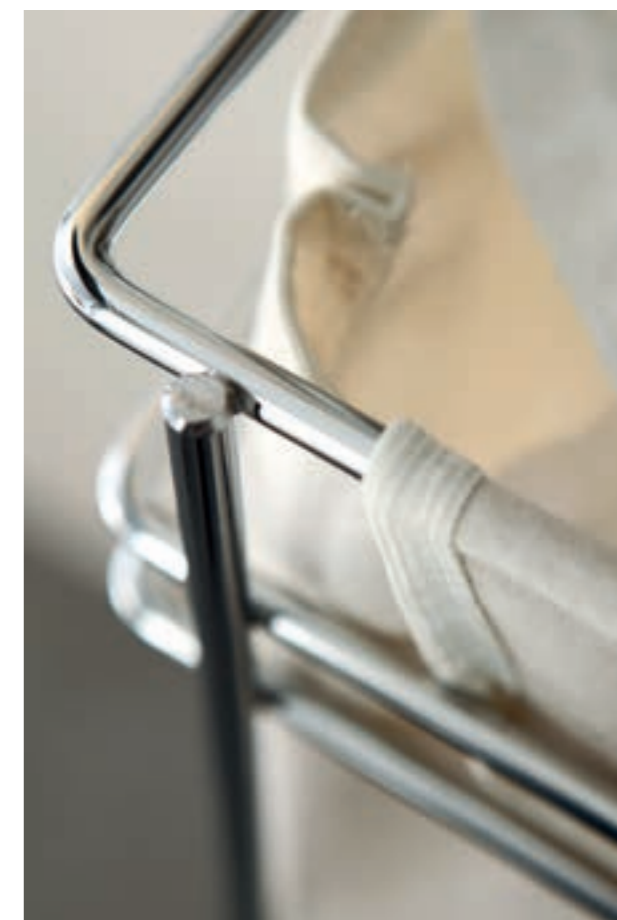

ELEGANZA FUNZIONALE

Comoda praticità nella zona lavanderia



Una base con la finitura in larice bicolore ecrù e una struttura verticale a spalla in Unicolor Cesar Brown spessore 6 cm: la lavanderia moderna scopre il vantaggio di una progettualità libera, con il cesto portabiancheria estraibile e il lavabo in ceramica.

A two colour ecrù brushed larch finish base and a 6 cm thick vertical structure with Unicolor Cesar Brown back support: the modern laundry room boasts design freedom, with the extractable laundry basket and ceramic wash basin.





lavabo in CERAMICA / ceramic wash basin



SOLUZIONE AD ANGOLO



Il volume interno dell'angolo è accessibile grazie ad un ripiano in Unicolor Cesar Brown da 6 cm dove poter riporre accessori e detersivi.

The entire corner space is accessible thanks to a 6 cm, Unicolor Cesar Brown shelf on which it is possible to place accessories and detergents.



Due piani profondi 63 cm si incontrano a formare un vano a giorno racchiuso tra la base portavabo e le colonne attrezzate. Una composizione studiata per il massimo sfruttamento dell'angolo.

Two 63 cm deep tops come together to form an open unit between the wash basin base and the equipped tall units. A composition designed to make the most out of the corner space.

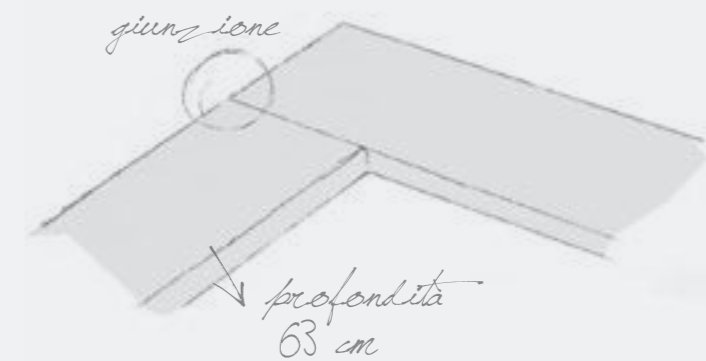



COLONNE ATTREZZATE

per ogni esigenza di spazio

Vani attrezzati con asse da stiro, cestelli e barra appendiabiti estraibili si affiancano a vani con divisori e ripiani interni per tenere le scope e l'aspirapolvere separati da accessori e flaconi.

Units equipped with ironing boards, baskets and extractable clothes hangers are united with units with dividers and internal shelves which separate brooms and vacuum cleaners from accessories and bottles.





CESTONE CON CHIUSURA DI SICUREZZA

Con chiave in dotazione



Detersivi, disinfettanti, smacchianti: in lavanderia ci sono sempre prodotti pericolosi che è meglio tenere sotto chiave. Per questo uno dei contenitori della base è provvisto di serratura, in modo che i bambini non corrano alcun rischio.

Detergents, disinfectants, stain removers: there are always dangerous products in the laundry room; it is best to keep them locked away. For this very purpose, one of the storage units is equipped with a lock, so that there is no risk to children.



Elemento estraibile con contenitori e cestino completo di coperchio.

Extractable element with storage units and basket complete with cover.

Contenitore estraibile dal telaio di protezione con chiusura a chiave.

Extractable storage unit with protective frame and lock.



**TOP IN TEKNORIL sp 1,2 cm
LUCIDO E OPACO**
con vasca integrata Conca

**GLOSS AND MATT TEKNORIL
TOP - 1.2 cm thick**
with built-in Conca wash basin

Lunghezza massima 210 cm
Il lavabo viene posizionato a scelta

Maximum length 210 cm
The hole can be placed where desired

Doppia profondità
51 / 63 cm

Double depth
51 / 63 cm

Misure interno vasca
L 53 / P 38 / H 20 cm

Internal basin dimensions
W 53 / D 38 / H 20 cm

LAVABO IN TEKNORIL A MISURA

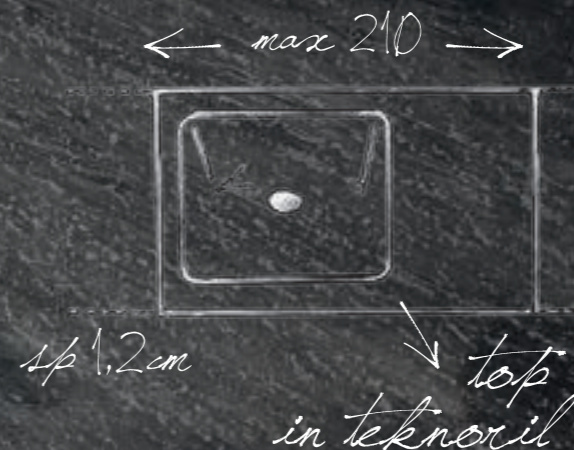

L'ANIMA TRADIZIONALE
E QUELLA TECNOLOGICA
DELLA LAVANDERIA
SI INCONTRANO IN
UNA COMPOSIZIONE
ERGONOMICA E
ORIGINALE IN BIANCO
LUCIDO CON MANIGLIA
CROMO E MENSOLE IN
UNICOLOR PORFIDO.

THE TRADITIONAL AND TECHNOLOGICAL
SPIRIT OF THE LAUNDRY ROOM
FUSE WITHIN AN ERGONOMIC AND
ORIGINAL COMPOSITION IN GLOSS
WHITE WITH CHROME HANDLES AND
UNICOLOR PORFIDO SHELVES.





lavabo in TEKNORIL / Teknoril wash basin



LE COLONNE RIALZATE

La comodità e la praticità in un'unica soluzione



Lavatrice e asciugatrice si trovano all'altezza ideale nelle due colonne in appoggio sulla struttura in Unicolor Porfido. Sotto si inseriscono i due carrelli portabiancheria in metallo bianco. E per i capi da lavare a mano, c'è il lavabo integrato in teknoril completo di tavoletta lavabiancheria e alzatina sagomata di protezione.

The washing machine and tumble-dryer can be found at the perfect height within the two supporting units of the Unicolor Porfido structure. The two white metal laundry trolleys can be placed underneath. When it comes to items which require hand washing, there is the built-in teknoril wash basin complete with laundry board and shaped protective splash-guard.

base portabiancheria

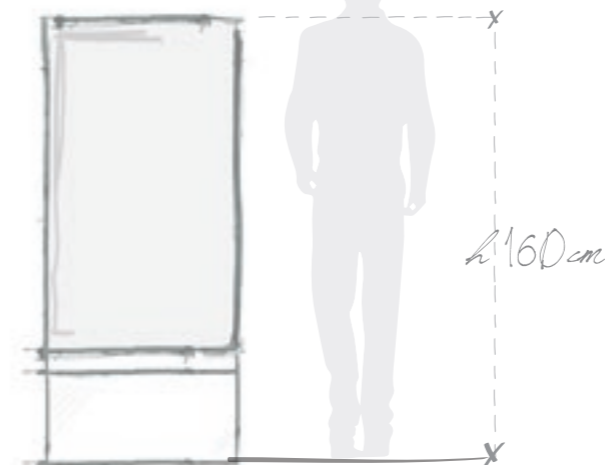



lavabo in TEKNORIL / Teknoril wash basin



DOPPIA PROFONDITÀ

P 51 con rubinetteria a muro
P 63 con rubinetteria a muro o sul top

→
La base sospesa con top e lavabo integrato, è completa di tavoletta lavabiancheria in teknoril a due posizioni. Il tutto è racchiuso da fianchi di finitura e top inferiore laccato bianco opaco.

The wall base unit with top and built-in wash basin is completed with the two-position teknoril laundry board. Everything is encapsulated within finishing sides and matt white lacquered base top.

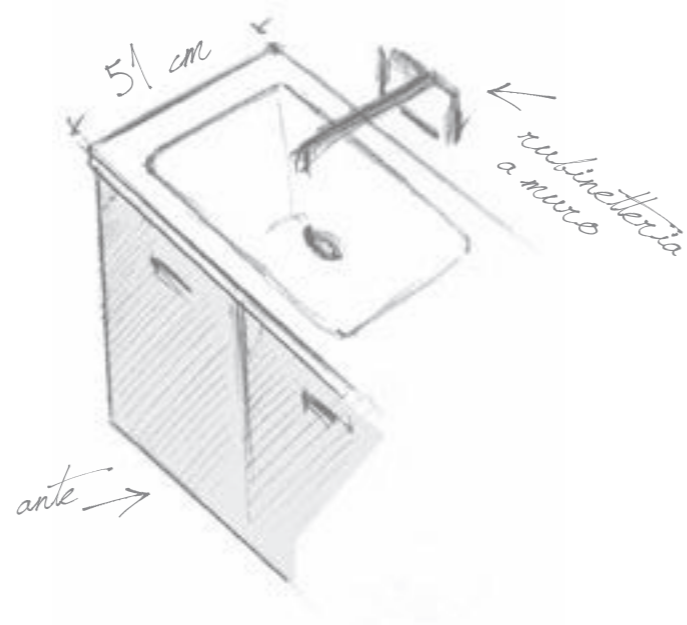

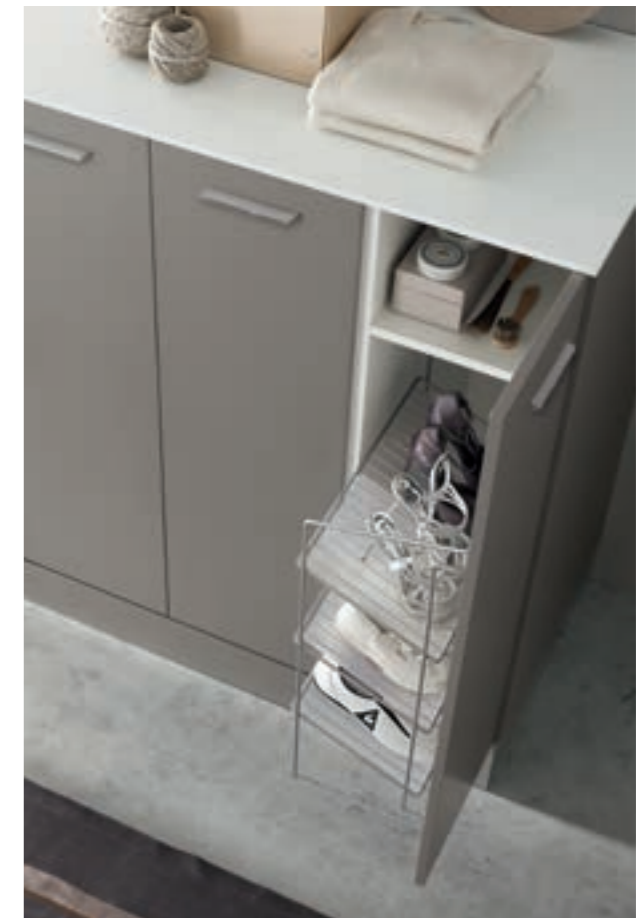

VERSATILE E RAZIONALE

Progetti per creare e arredare stili diversi



Nella colonna portalavatrice a due ante alta 125 cm un ripiano superiore crea due vani per gestire più comodamente le operazioni. Dall'altro lato, una colonna con portascarpe estraibile in tondino metallico aggiunge un'ulteriore e utile funzionalità.

Within the two-door washing machine unit, 125 cm in height, a top shelf serves to establish two compartments to enable convenient management of activities. On the other side, a tall unit with extractable shoe holder in metal reinforcing rod provides yet another useful function.





lavabo in TEKNORIL / Teknoril wash basin





COLONNA PRATICA E FUNZIONALE

Soluzioni attrezzate, per riporre tutti gli oggetti



La colonna alta 200 cm è progettata per contenere l'aspirapolvere. Il fianco è attrezzato con appendini portascopie e l'anta con l'accessorio avvolgitubo e porta detersivi. Un'idea multifunzionale e salvaspazio inserita nella composizione.

The 200 cm tall unit is designed to store the vacuum cleaner. The side is equipped with hanging door organisers and the door with hose reel and detergent holder. A multifunctional and space-saving idea, all part of the composition.





PIANO CON VASCA
INTEGRATA E
TAVOLETTA IN
TEKNORIL DA USARE
COME CHIUSURA A
MEZZA PROFONDITÀ
O COME APPOGGIO
PER IL LAVAGGIO.
UNA LAVANDERIA,
TANTE IDEE.

TOP WITH BUILT-IN WASH BASIN
AND BOARD IN TEKNORIL TO BE
USED AS A CLOSURE AT HALF
DEPTH OR AS A SUPPORT WHEN
WASHING. ONE LAUNDRY ROOM,
COUNTLESS IDEAS.



lavabo in MINERALGUSS / Mineralguss wash basin

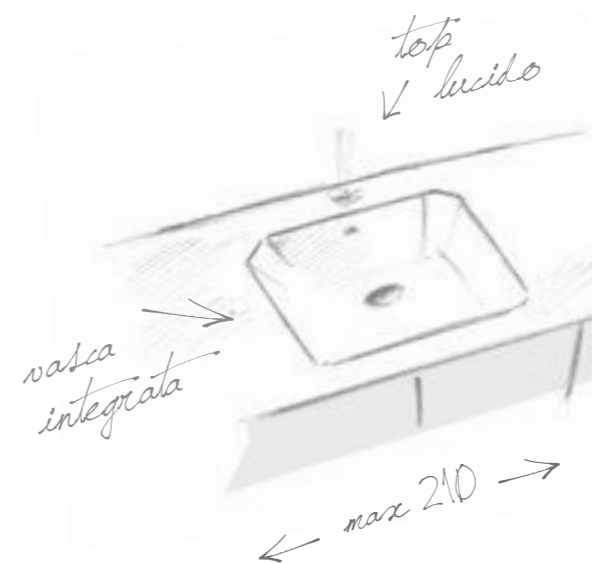

LAVABO IN MINERALGUSS

Con vasca integrata
(misure interne L 51 / P 33 / H 21 cm)

→
La composizione segue criteri di praticità valorizzando l'armonia di ogni soluzione, dalle colonne porta lavatrice e asciugatrice ai vani a giorno, dai contenitori al piano lavabo con vasca molto capiente e un'ottima superficie d'appoggio.

The composition takes into consideration practicalities whilst heightening the balance of each solution, from the washing machine and tumble-dryer tall units to the various open units, from the storage units to the wash basin top, with extremely capacious basin and excellent support surface.

TOP 1,2 cm
versione lucido

Lunghezza massima 210 cm
Il foro viene posizionato a scelta

Doppia profondità
51 / 63 cm

TOP 1,2 cm
gloss version

Maximum length 210 cm
The hole can be placed where desired

Double depth
51 / 63 cm



LAVABO SEMINCASSO IN MINERALGUSS

P 38 con rubinetteria a muro
P 51 con rubinetteria a muro o sul top
P 63 con rubinetteria a muro o sul top



Il lavabo integrato nel piano sporge leggermente per avere una vasca di comoda ampiezza senza dover aumentare la profondità della base sospesa. La gestione dello spazio stabilisce nuove relazioni tra ingombri e praticità.

The wash basin built into the top overhangs slightly providing a large basin without having to increase the depth of the wall hung base unit. Space management takes on new meaning with the associations between measurements and practicalness.

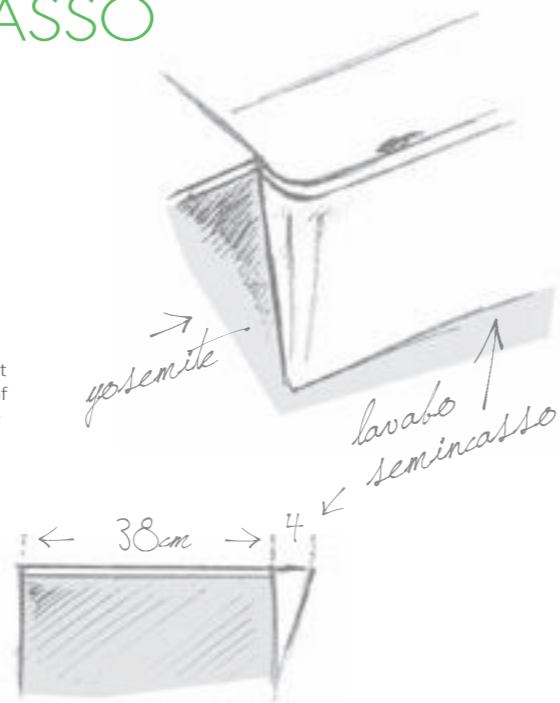

lavabo in MINERALGUSS / Mineralguss wash basin

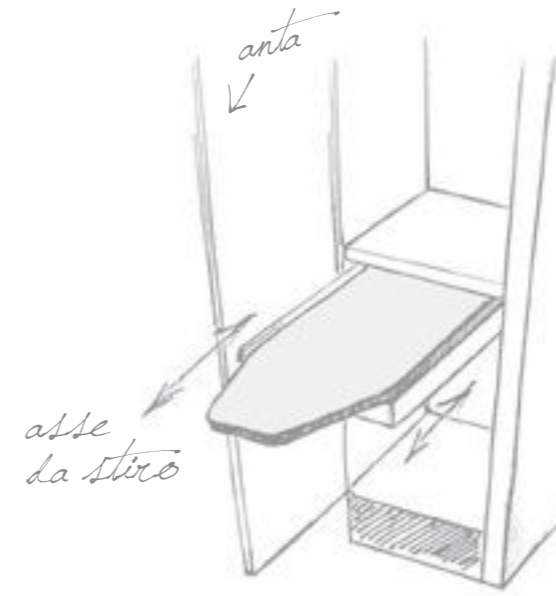
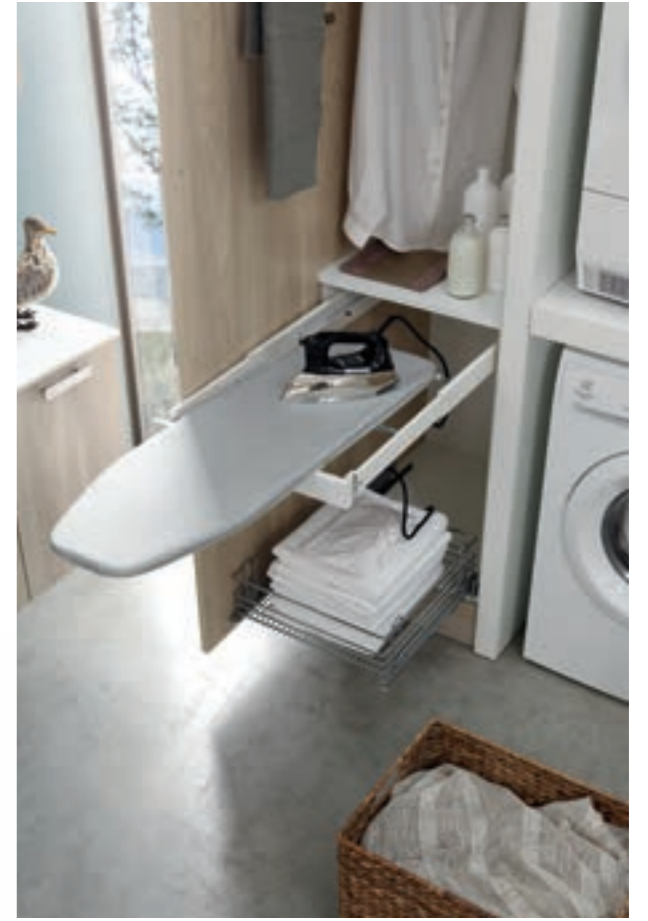

L'ASSE DA STIRO ESTRAIBILE

Praticità in lavanderia



Lavare, asciugare e stirare: un'unica struttura con colonne attrezzate e vani tecnici riunisce le principali funzioni della lavanderia. E' una soluzione ideale per trasformare un locale di dimensioni contenute in un ambiente comodo e funzionale.

Washing, drying and ironing: a single structure with equipped tall units and technical compartments brings together the main functions of the laundry room. The ideal solution to transform an area with limited space into a convenient and functional room.

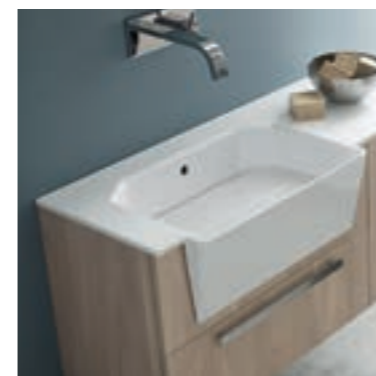



W&D
Wash'n'dry



THE NEW CONCEPT OF LAUNDRY

IL NUOVO CONCETTO
DELLA LAVANDERIA

composizioni
Compositions

modularità
Modularity

finiture
Finishes

maniglie
Handles

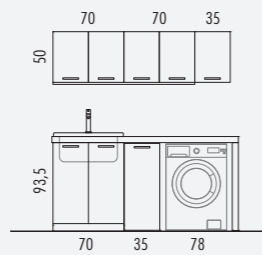

**W&D 01****L 183 P 63 cm**

Agata opaco con maniglia 163 cromo
Lavabo incasso in ceramica Balnea
Top unicolor Bianco Dax sp.6 cm

Matt Agata with 163 chrome handle
Built-in ceramic Balnea wash basin
6 cm thick Unicolor White Dax top

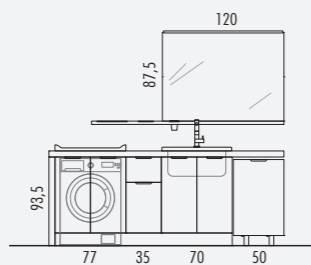
**W&D 02****L 232 P 63 cm**

Frassino bianco con maniglia 243 brill
Lavabo incasso in ceramica Balnea
Top unicolor Cemento sp.6 cm

White ash with 243 brill handle
Built-in ceramic Balnea wash basin
6 cm thick Unicolor Cemento top

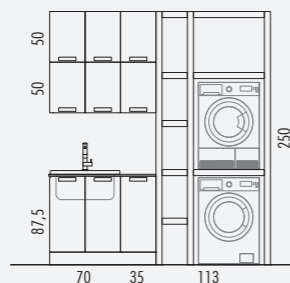
**W&D 03****L 219 P 51 cm**

Larice bicolore ecrù con maniglia 253 cromo
Lavabo incasso in ceramica Balnea
Top unicolor Cesar Brown sp.6 cm

Two-tone ecru larch with 253 chrome handle
Built-in ceramic Balnea wash basin
6 cm thick Unicolor Cesar Brown top

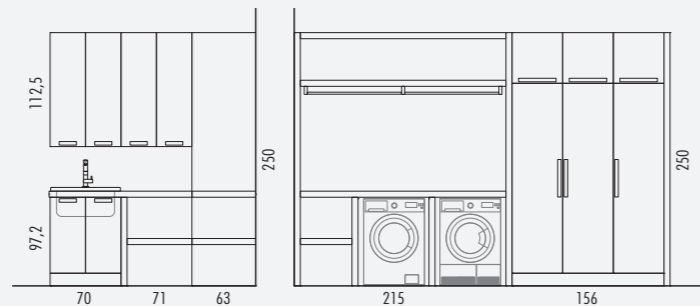
**W&D 04****L 204/371 P 63 cm**

Bianco opaco con maniglia 253 cromo
Lavabo incasso in ceramica Balnea
Top unicolor Grigio Venato sp.6 cm

Matt white with 253 chrome handle
Built-in ceramic Balnea wash basin
6 cm thick Unicolor Grigio venato top

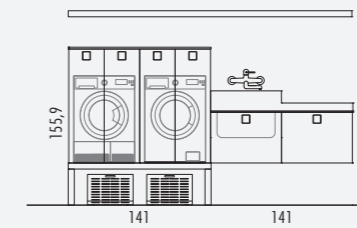
**W&D 05****L 281 P 51/63 cm**

Bianco lucido con maniglia 263 cromo
Particolari Unicolor Porfido
Top in teknoril con lavatoio integrato Conca

Gloss white with 263 chrome handle
Unicolor Porfido details
Top in teknoril with built-in Conca washtub

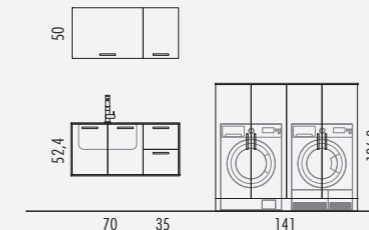
**W&D 06****L 107,5 P 63 + 2 colonne L 70 P 63 cm**

Magma opaco con maniglia 163 cromo
Top in teknoril sp.1,2 cm
con lavatoio integrato Conca

Matt Magma with 163 chrome handle
1.2 cm thick teknoril top
with built-in Conca washtub

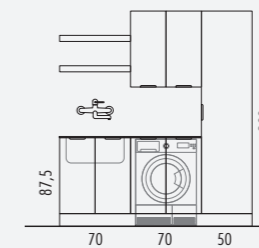
**W&D 07****L 191 P 51 cm**

Rovere tranchè canapa con particolari
rovere tranchè marrone
Maniglia 243 brill
Top in teknoril sp.1,2 cm
con lavatoio integrato Conca

Canapa tranchè oak with Marrone tranchè oak
details 243 brill handle
1.2 cm thick teknoril top
with built-in Conca washtub

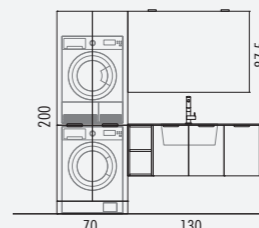
**W&D 08****L 201 P 51/63 cm**

Bianco lucido con maniglia 243 brill
Top in mineralguss sp.1,2 cm
con lavatoio integrato Fonte

Gloss white with 243 brill handle
1.2 cm thick mineralguss top
with built-in Fonte washtub

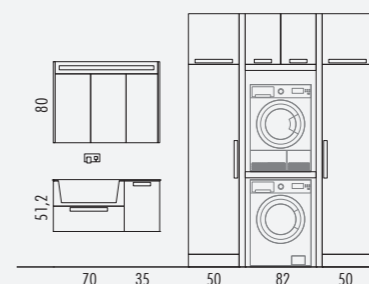
**W&D 09****L 106 P 38/42 + colonne L 182 P 51 cm**

Yosemite chiaro con particolari Unicolor bianco dax
Maniglia 253 cromo
Top in mineralguss sp.1,2 cm
con lavatoio semincasso integrato Fonte

Light Yosemite with Unicolor White Dax details
253 chrome handle
1.2 cm thick mineralguss top
with built-in semi-recessed Fonte washtub

Pensili p. 20,8 / 37 cm

Wall units

| H 50 | H 75 | H 112,5 | H 50 | H 75 | H 112,5 | H 50 | H 50 |
|------------------|------------------|------------------|-------------------|-------------------|-------------------|------------------|---|
| L 25 35 | L 25 35 | L 25 35 | L 50 L 70 | L 50 L 70 | L 50 L 70 | L 50 L 70 | L 70 |
| | | | | | | | |
| 1 anta 1 door | 1 anta 1 door | 1 anta 1 door | 2 ante 2 doors | 2 ante 2 doors | 2 ante 2 doors | 1 anta 1 door | a ribalta flap a ribalta con fondo stendibiancheria flap with bottom drying rack |

Basi a terra p. 37 / 50 / 62 cm

Floor-standing base units

| H 87,5 | | | | | | |
|--|--------------------------------------|-------------------------|--------------------------------|------------------|-------------------|---------------------------------------|
| L 25 35 | L 25 35 | L 25 35 | L 50 L 70 | L 35 L 50 | L 50 L 70 | L 50 L 70 |
| | | | | | | |
| 1 anta 1 door | 1 anta+1 cassetto 1 door+1 drawer | 3 cassetti 3 drawers | solo P 50/62* only D 50/62* | 1 anta 1 door | 2 ante 2 doors | 2 ante+1 cassetto 2 doors+1 drawer |
| *a ribalta con cesto porta biancheria *flap with bottom drying rack | | | | | | |

Basi sospese p. 37 / 50 / 62 cm

Wall-mounted base units

| H 50 | | | | | | |
|------------------|-------------------------|------------------------|------------------------------|------------------------|-------------------|-------------------|
| L 25 35 L 50 | L 25 35 L 50 L 70 | L 25 35 L 50 L 70 | L 25 35 L 50 L 70 | L 25 35 L 50 L 70 | L 25 35 L 50 L 70 | L 25 35 L 50 L 70 |
| | | | | | | |
| 1 anta 1 door | 2 cassetti 2 drawers | 1 cassetto 1 drawer | solo P 37/50 only D 37/50 | a giorno open units | 2 ante 2 doors | |

Colonne p. 37 / 50 / 62 cm

Tall units

| H 125 | H 200 | H 50 | | H 50 | |
|--|-------------------|---------------------------------------|-------------------|-------------------|---------------------------------------|
| L 25 35 | L 25 35 | L 25 35 | L 25 35 | L 50 L 70 | L 50 L 70 |
| | | | | | |
| 1 anta 1 door | 2 ante 2 doors | 2 ante+1 cassetto 2 doors+1 drawer | 2 ante 2 doors | 4 ante 4 doors | 4 ante+1 cassetto 4 doors+1 drawer |
| solo P 50/62* only D 50/62* | | | | | |
| *a ribalta con cesto porta biancheria *flap with bottom drying rack | | | | | |

Colonne e basi portalavatrice p. 50 / 62 cm

Tall units and washing machine bases

| H 87,5 | H 125 | H 200 |
|-------------------|-------------------|-------------------|
| L 70 | L 70 | L 70 |
| | | |
| 2 ante 2 doors | 2 ante 2 doors | 4 ante 4 doors |

Basi portalavabo sospese p. 37 / 50 / 62 cm

Washing machine wall-mounted base units

| H 50 | | | | | | |
|-------------------|-------------------------------|-----------------------|---|-------------------------------|--|---|
| L 70 | L 70 L 85 L 95 L 105 | L 85 L 95 L 105 | L 70 L 85 L 95 L 105 | L 70 L 85 L 95 L 105 | L 85 L 95 L 105 | L 85 L 95 L 105 |
| | | | | | | |
| 2 ante 2 doors | 1 cassetto 1 drawer | 3 ante 3 doors | 1 fisso+ 1 cassetto 1 fixed 1 drawer | 2 cassettoni 2 drawers | 2 ante+ 2 cassettoni 2 doors+ 2 drawers | 1 cassetto+ 2 cassetti 1 drawer+ 2 drawers |

Basi portalavabo a terra p. 37 / 50 / 62 cm

Washing machine floor-standing base units

| H 87,5 / P 37 | | | H 87,5 / P 50-62 |
|---------------|-----------------------|------|------------------|
| | | | |
| L 70 | L 85 L 95 L 105 | L 95 | L 70 |

Accessori

Accessories

H 87,5 / L 35 / P 37

Carrello con ruote
Wheeled trolley

H 87,5 / L 50 / P 50

Carrello attrezzato con ruote
Trolley equipped with wheels



YOSEMITE

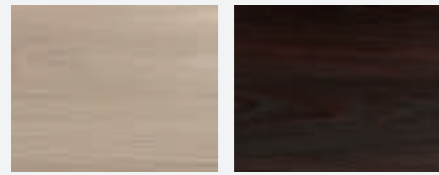

Chiaro Scuro

ROVERE TRANCÈ



Ecrù Canapa Marrone

CONDOTTI

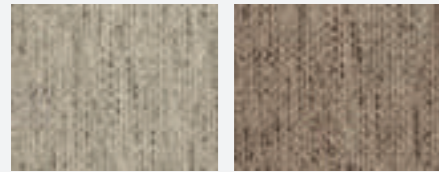

Safari Argilla

LARICE

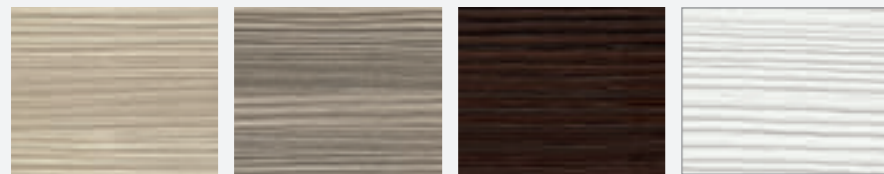

Ecrù Canapa Marrone Bianco

FRASSINO

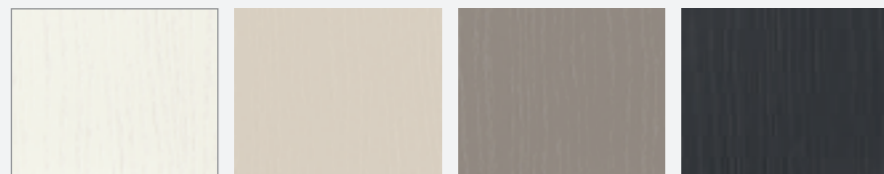

Bianco Champagne Zenzero Ardesia

SHERWOOD

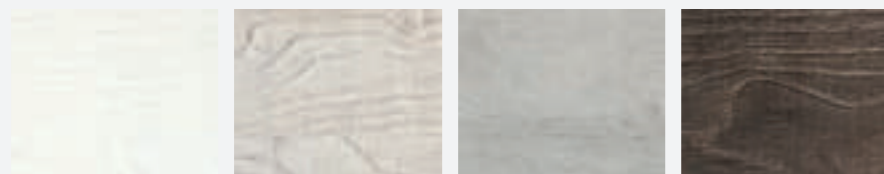

Luna Platino Polvere Burn

LARICE E FRASSINO NEI 38 COLORI

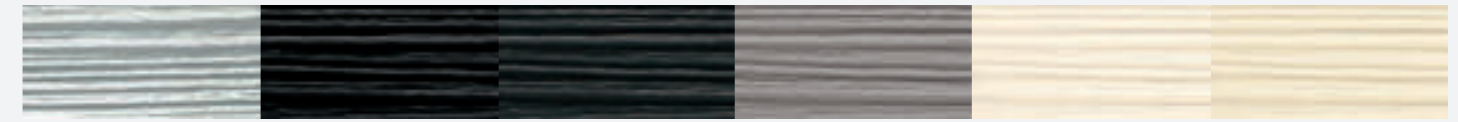

Inox Nero/Black Grigio fumo di Londra Cenere New Pergamon Ecrù

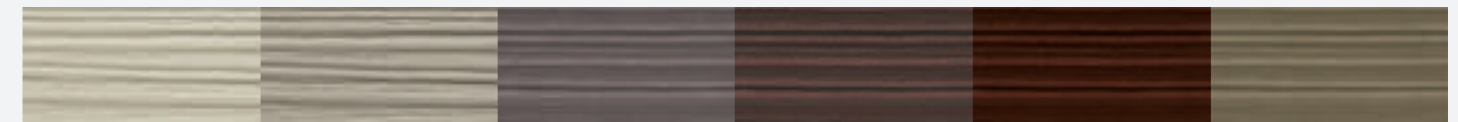

Juta Canapa Terranova Brown Cacao Terra



Visone Verde Bosco Verde Oliva Giallo Polline Giallo Solare Mattone



Rosso fuoco Bordeaux Rosso India Blu Night Blu Marin Blu Nazionale



Cascata Cielo Nuvola Navy Lavanda Glicine



Lilla Light Rosa Rosa Confetto Amarena Lampone Arancio



Verde Twigg Acquamarina

COLORE



Bianco lucido e opaco Sabbia lucido Rosso Marocco lucido Agata lucido e opaco Magma lucido e opaco Grigio antracite lucido e opaco



Maniglie disponibili

Handles available



Art. 243 brill - brill



Art. 253 cromo - chrome



Art. 163 cromo - chrome
Art. 165 alluminio - aluminium



Art. 323 cromo - chrome



Art. 263 cromo - chrome



Art. 283 cromo - chrome



Art. 273 cromo - chrome
Art. 271 bianco - white



By ARCOM srl

33070 Maron di Brugnera (PN) Italy
Viale Lino Zanussi, 34/B
T. +39.0434.613619 / 1573020
F. +39.0434.608137
info@arcombagno.com

design for your bathroom

46



Profondità
Depth

ak
bathstyle

46



Profondità
Depth

ak
bathstyle

46

Profondità
Depth

La nuova dimensione del bagno

it — L'arredo bagno 46 trova spazio in ambienti dove ogni centimetro è prezioso: la profondità ridotta permette di arredare con funzionalità e stile anche i bagni più piccoli o dove ci sono particolari esigenze e ingombri da rispettare. Una collezione salvaspazio.

en — Give your bathroom a new dimension
The 46 collection has been designed for bathrooms in which every centimetre counts. The depth of all the units has been reduced, so you can furnish the most compact spaces with functional style, even where you are tied to specific restrictions. A space-saving collection.



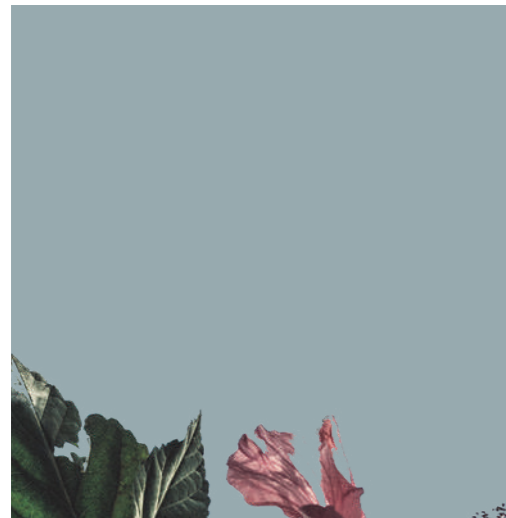

Nuove idee per arredare con effetti legno e colori opachi

Wood effects and matt colours: new ideas to furnish your space

Bathroom

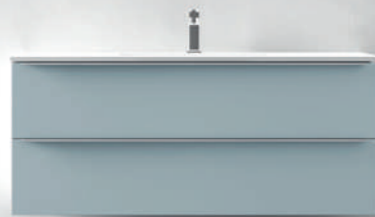

05 Nobilitati effetto legno

Wood-effect melamine

- SABLE BEIGE
- SABLE MARRONE
- SABLE BIANCO
- CHÊNE NATUREL
- ROVERE CORTINA



06 Nobilitati colore opaco

Melamine matt colour

- BIANCO NEVE
- GRIGIO MEDIO
- GRIGIO CHIARO
- GRIGIO SCURO
- AZZURRO
- ROSSO CARDINALE



Style

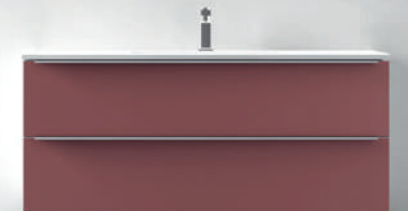

it — La collezione 46 può essere personalizzata con venature o colori pieni per adattarsi a diversi stili di arredamento. Naturale, moderno, minimal, elegante: l'arredo bagno esprime la personalità dell'ambiente e delle persone che lo vivono quotidianamente.

en — The 46 collection can be customised with wood grain or solid colour to suit different furnishing styles. Natural, modern, minimalist and elegant: say something about you and your home, with your bathroom furniture.

Mood



Meno
profondità,
più spazio:
il mobile
si riduce
e tu hai una
maggiore
libertà di
movimento.



46

PROFONDITÀ 50 CM
Dimensione standard
Size standard

it — La collezione 46 ha una profondità ridotta rispetto allo standard per portare un arredo confortevole e pratico anche in ambienti di piccole dimensioni. Una soluzione perfetta per arredare il bagno degli ospiti o il secondo bagno di casa senza rinunciare allo stile.

en — Less depth, more space: the compact unit gives you more freedom of movement
The 46 collection is less deep than the standard size, offering you measured, practical furniture even in a smaller space. It is the perfect solution for a guest or second bathroom, without sacrificing style.

Nobilitato

Effetto legno

it — Una selezione di venature per portare il calore delle essenze nell'ambiente bagno: bianche, naturali e scure caratterizzano diversi stili di arredo.

en — Wood-effect melamine
A choice of wood-grain finishes bring warmth to your bathroom: white, natural and dark, to define different furnishing styles.



Finiture disponibili
Available finishes

SABLE BEIGE
SABLE MARRONE
SABLE BIANCO
CHÊNE NATUREL
ROVERE CORTINA



SABLE BEIGE

comp. 46 — 01
L 90 x P 46 cm

Scocca e frontale
Sable Beige con particolari
bianco Neve opaco
Top unicolor
Pulpis Light sp. 3,8 cm
Lavabo "tutto Fuori"
Sky in mineralguss

Body and front
Sable Beige with
matt Bianco Neve details
Unicolor top
Pulpis Light 3.8 cm thick
Sky countertop washbasin
in Mineralguss

Piccoli spazi arredati con stile

it — Il mobile da bagno è semplice e lineare
ma estremamente funzionale: tutto ciò che
serve è a portata di mano.

en — Small spaces furnished in style
The bathroom furniture is simple, linear but
extremely functional. You have everything
you need to hand.



it — I pensili chiusi e i moduli a giorno aggiungono spazio utile sulla parete e creano composizioni originali.

en — The wall units and open compartments add useful wall space and create an original composition.



SABLE MARRONE

comp. 46 — 02
L 120 x P 46 cm

Scocca e frontale
Sable Marrone
Lavabo consolle
Keope in mineralguss

Body and front
Sable Marrone
Keope console
washbasin
in Mineralguss



SABLE MARRONE

comp. 46 — 03
L 120 x P 46 cm

Scocca e frontale
Sable Marrone
Top unicolor
Pulpis Dark sp. 3,8 cm
Lavabo "tutto fuori"
Thin 45 in ceramica

Body and front
Sable Marrone
Unicolor top
Pulpis Dark 3.8 cm thick
Thin 45 countertop
washbasin in ceramic

it — La specchiera contenitore e i pensili moltiplicano lo spazio a disposizione con lo stesso stile del mobile da bagno.

en — The mirrored storage unit and wall units increase the available space, in the same style as the bathroom furniture.

Volumi aperti e sospesi

it — I moduli a giorno si inseriscono nella base e aprono nuovi spazi per contenere ed esporre allo stesso tempo.

en — Open and wall-mounted spaces
Open compartments in the base unit open up new storage space, where you can also put things on display.





SABLE BIANCO

comp. 46 — 04
L 100 x P 46 cm

Scocca e frontale
Sable Bianco
Lavabo consolle Tube
in ceramica

Body and front
Sable Bianco
Tube console
washbasin in ceramic



it — Il lavabo consolle si estende in lunghezza per offrire il massimo della capienza e della praticità.

en — The console washbasin extends lengthways to offer maximum capacity and practicality

SABLE BEIGE

comp. 46 — 05
L 80 x P 46 cm

Scocca e frontale
Sable Beige
Lavabo consolle
Just in ceramica

Body and front
Sable Beige
Console washbasin
Just in ceramic





it — Una serie di colonne affiancate crea una parete attrezzata. Ante e cassetti facilitano l'organizzazione.

en — A series of tall units side by side creates a well-equipped feature wall. Doors and drawers make the space easy to organise.



Colonna
a terra con 2 ante
+ 1 cassetto
Floor-standing tall
unit with 2 doors
+ 1 drawer
L 30
H 187,5
P 37 cm

Colonna
a terra con 1 anta
+ 2 cassetti
Floor-standing tall
unit with 1 door
+ 2 drawers
L 30
H 187,5
P 37 cm

Colonna
a terra con
1 anta
Floor-standing
tall unit with
1 door
L 30
H 187,5
P 37 cm

CHÊNE NATUREL

comp. 46 — 06
L 120 x P 46 cm
+ colonna L 30 cm

Scocca e frontale
Chêne Naturel
con particolari
Bianco Neve
Lavabo consolle
Slim in ceramica

Body and front
Chêne Naturel with
Bianco Neve details
Slim console
washbasin in ceramic

Arredi salvaspazio per la nicchia

it — La base sospesa, lo specchio
contenitore e la colonna arredano poco
spazio con tanto stile.

en — Space-saving furniture for the alcove
The wall-mounted base unit, mirrored
storage unit and tall unit furnish a small
space with a lot of style.





it — All'interno della colonna ogni cosa trova il suo posto: ripiani per la biancheria e cassetti per trucchi e accessori.

en — Everything has its place inside the tall unit. There are shelves for towels and drawers for make-up and accessories.



**Colonna
sospesa 1 anta
+ 2 cassetti**

Wall-mounted tall
unit with 1 door
+ 2 drawers

L 30
H 162,5
P 37 cm

**Colonna
sospesa
1 anta**

Wall-mounted
tall unit
1 door

L 30
H 162,5
P 37 cm

**Colonna
sospesa
2 ante**

Wall-mounted
tall unit
2 doors

L 30
H 162,5
P 37 cm



SABLE BIANCO

comp. 46 — 07
L 60+30+60 x P 46/20,8 cm

Scocca e frontale
Sable Bianco
con particolari
Grigio chiaro opaco
Lavabo consolle
Figura in Solid Surface

Body and front
Sable Bianco with
matt Grigio Chiaro details
Figura console washbasin
in Solid Surface

it — Due mobili uguali e pensili al centro:
se l'ambiente è ampio può essere progettato
per dare ad ognuno il proprio spazio.

en — Two identical units with a column in the
middle: if you have a larger room, everyone can
have their own space with this design.



Stile e funzionalità per due

it — Il doppio lavabo aumenta la praticità di tutti i giorni senza occupare troppo spazio.

en — Style and purpose for two
Two washbasins mean a more practical everyday set-up, without taking up too much space.

ROVERE CORTINA

comp. 46 — 08
L 100 x P 46 cm
+ basi 60 + 60 cm

Scocca e frontale
Rovere Cortina
Lavabo consolle
Just in ceramica

Body and front
Rovere Cortina
Just console
washbasin in ceramic





it — I piedini in metallo sono funzionali per sostenere la base, ma diventano anche dettagli di stile.

en — The metal feet support the base unit, but also become stylish details.





Gli specchi completano l'arredo

it — In tutte le sue forme e misure,
in bagno lo specchio è sempre utile e decorativo.

en — Mirrors to complete the look
In all shapes and sizes, a bathroom mirror is
always useful and decorative.



Specchiera "Disco"
con faretto Kira o luce led
"Disco" mirror
with Kira spotlight or LED light
Ø 40 - 60 - 80 cm

it — Sopra il lavabo si possono creare composizioni con specchiere tonde di varie dimensioni.

en — You can create compositions with round mirrors in various sizes above the washbasin.



Specchiera "Mini"
Con profilo brill o nero
Disponibile con faretto - senza presa interruttore

"Mini" mirror
With Brill or Nero profile
Available with spotlight - without socket and switch

L 60 - 70 - 80 - 90 - 100 - 120 x H 75 cm



Specchiera "Easy" P 19,4 cm
Disponibile con faretto - con presa interruttore

Specchiera "Easy" P 19,4 cm
Available with spotlight - without socket and switch

L 60 - 70 - 80 - 90 - 100 - 120 x H 75 cm

Nobilitato

Colore opaco

it — Una selezione di colori per dare ad ogni ambiente uno stile: minimal con il bianco, moderno con i grigi, fresco con l'azzurro ed elegante con il rosso.

en — Melamine matt colour
There is a selection of colours to give each room its own style: minimalist white, modern grey, fresh blue and elegant red.



Finiture disponibili
Available finishes

BIANCO NEVE
GRIGIO MEDIO
GRIGIO CHIARO
GRIGIO SCURO
AZZURRO
ROSSO CARDINALE



GRIGIO MEDIO

comp. 46 — 09
L 120 x P 46 cm

Scocca e frontale
Grigio medio opaco
Top unicolor
Pulpis Light sp. 3,8 cm
Lavabo "tutto Fuori"
Sky in mineralguss

Body and front
Matt Grigio Medio
Unicolor top
Pulpis Light 3.8 cm thick
Sky countertop
washbasin in Mineralguss

Il lato essenziale del design

it — La linearità dell'arredo è valorizzata dal dettaglio delle maniglie, dal lavabo in appoggio e dalla specchiera retroilluminata.

en — The simple side of design
The handles, countertop washbasin and backlit mirror add interest to the linear furniture style.

Tipologie di lavabi in appoggio



Lavabo Sky
in mineralguss bianco opaco
Sky washbasin
in matt white Mineralguss
Misure esterne - External size
L 48 x P 32 x H 12,5 cm
Misure interne - Internal size
L 47 x P 31 x H 11 cm



Lavabo Thin 45
in ceramica bianco lucida
Thin 45 washbasin
in glossy white ceramic
Misure esterne - External size
L 45 x P 45 x H 11 cm
Misure interne - Internal size
L 43,6 x P 31,3 x H 8 cm



Lavabo Thin 55
in ceramica bianco lucida
Thin 55 washbasin
in glossy white ceramic
Misure esterne - External size
L 55 x P 45 x H 11 cm
Misure interne - Internal size
L 53,6 x P 31,3 x H 8 cm

it — Il lavabo è appoggiato sul piano e in tutte le sue forme rende elegante anche gli arredi più semplici.

en — Types of countertop washbasins
The washbasin rests on the unit top and makes even the simplest of furnishing styles elegant in all of its forms.



AZZURRO

comp. 46 — 10
L 60 x P 46 cm

Scocca e frontale
Azzurro opaco
Lavabo consolle
Keope in mineralguss

Body and front
in matt Azzurro
Keope console
washbasin in
Mineralguss



it — Piccolo e compatto, l'arredo bagno si colora di azzurro per rendere l'ambiente ancora più leggero.

en — Slight and compact, the bathroom furniture is coloured blue, to lighten the look even further.

GRIGIO CHIARO

comp. 46 — 11
L 70+30 x P 46 cm

Scocca e frontale
Grigio chiaro
con particolari
Sable Beige
Lavabo consolle
Slim in ceramica

Body and front
Grigio Chiaro with
Sable Beige details
Slim console
washbasin in ceramic

Tanto spazio per tutto

it — Lo spazio aumenta grazie alla specchiera contenitore e ai pensili abbinati al mobile. Una composizione completa.

en — Plenty of space for everything. Increase the space with a mirrored storage unit and wall units to match. The perfect composition.





it — Combinazioni personalizzate di elementi chiusi e aperti portano più spazio in bagno con originalità.

en — Combine open and closed units as you like to make more space in your bathroom in an original way.





GRIGIO SCURO

comp. 46 — 12
L 170 x P 46 cm

Scocca e frontale
Grigio scuro
Top unicolor
Pulpis Light sp. 3,8 cm
Lavabo "tutto fuori"
Thin 55 in ceramica

Body and front
Grigio Scuro
Unicolor top
Pulpis Light 3.8 cm thick
Thin 55 countertop
washbasin in ceramic

Un perfetto spazio condiviso

it — Due spazi distinti ma uniti nella stessa composizione: nella nicchia, il contenimento e la funzionalità raddoppiano.

en — The perfect shared space
Two distinct spaces, joined in the same composition: double the storage space and functionality in the alcove.



it — Elementi in essenza si inseriscono nell'arredo: movimentano la tinta unita e danno un tocco di naturalezza all'ambiente.

en — Units in wood grain are slotted into the furniture to bring the solid colour to life, and add a natural touch to the space.

Il dettaglio delle maniglie

it — Cromate o nere, le maniglie impreziosiscono i frontali con stili diversi e rendono pratica e agevole l'apertura di ante e cassetti.

en — Handle detail
Available in a chrome-plated or black finish, the handles decorate the fronts with different styles and make the doors and drawers practical and easy to open.

Tre modelli diversi di maniglie

it — Ogni maniglia ha la sua applicazione: direttamente sul frontale oppure lungo il profilo superiore dell'anta.

en — Three handle models
Each handle has its own application, whether directly on the front or along the upper door profile.



Maniglia
art.370-372
Disponibile
cromo o nera

Handle
Item 370-372
Available in
chrome or black



Maniglia
art.390-391
Disponibile
cromo o nera

Handle
Item 390-391
Available in
chrome or black



Maniglia
art.392-393
Disponibile
cromo o nera

Handle
Item 392-393
Available in
chrome or black

Il lavabo consolle per il mobile

it — La consolle è un lavabo che viene incassato sulla base. A seconda delle esigenze, offre capienza o diventa anche piano di appoggio.

en — Console washbasin for the unit.
The console washbasin is built into the base unit.
Depending what you need, it can be capacious or provide more surface space.



Lavabi integrati e capienti



Lavabo consolle Figura
in Solid Surface bianco lucido sp.13 cm
Figura console washbasin
in glossy white Solid Surface 13 cm thick



Lavabo consolle Tube
in ceramica bianco lucido sp.13 cm
Tube console washbasin
in glossy white ceramic 13 cm thick



Lavabo consolle Keope
in mineralguss bianco lucido Sp. 2 cm
Keope console washbasin
in glossy white Mineralguss 2 cm thick



Lavabo consolle Slim
in ceramica bianco lucido sp.1,8 cm
Slim console washbasin
in glossy white ceramic 1.8 cm thick



Lavabo consolle Just
in ceramica bianco lucido sp.7,5 cm
Just console washbasin
in glossy white ceramic 7.5 cm thick

it — I lavabi consolle sono disponibili in diversi materiali, spessori e configurazioni per adattarsi agli stili di arredo e alle necessità di spazio.

en — Large built-in washbasins
Console washbasins are available in different materials, thicknesses and configurations, to adapt to furnishing styles and space requirements.

Piano Top effetto marmo

da 3,8 cm



Top unicolor Pulpis Dark
sp.3,8 cm

Finiture disponibili
Available finishes

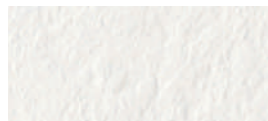

Bianco Dax



Pulpis Light

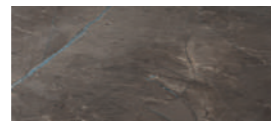

Pulpis Dark

Piano Top effetto legno

da 1,8 cm



Top effetto legno Sable Beige
sp.1,8 cm

Finiture disponibili
Available finishes



Chêne naturel



Rovere cortina



Sable bianco



Sable beige

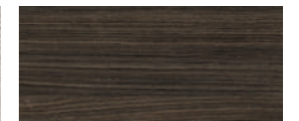

Sable marrone

Le specchiere e l'illuminazione

it — Le specchiere completano l'arredo bagno con diverse forme e dimensioni e possono essere integrate con luci a led.

en — Mirrors and lighting
The mirrors complete the bathroom furniture adding different shapes and sizes.
You can also add LED lights.

Specchi decorativi o contenitori

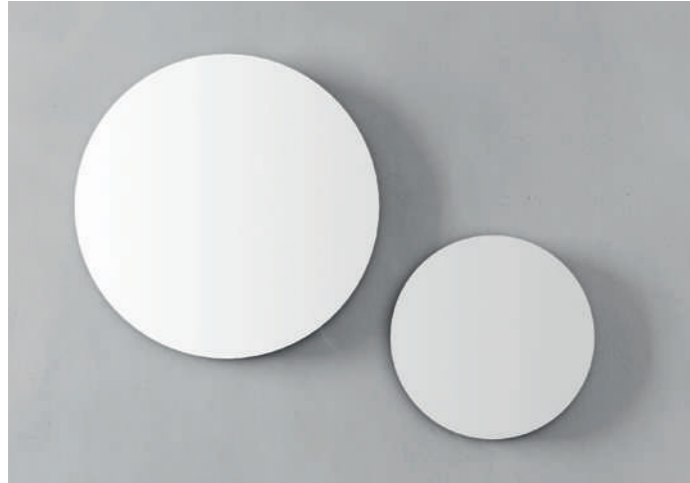

Specchiera "Disco"

Ø 40 - 60 - 80 cm
Con faretto Kira o luce led - senza presa interruttore

"Disco" mirror

Ø 40 - 60 - 80 cm
With Kira spotlight or LED light - without socket and switch



Specchiera "Mini"

Con profilo brill o nero
L 60 - 70 - 80 - 90 - 100 - 120 x H 75 cm
Disponibile con faretto - senza presa interruttore

"Mini" mirror

With Brill or Nero profile
L 60 - 70 - 80 - 90 - 100 - 120 x H 75 cm
Available with spotlight - without socket and switch



Specchiera "Easy" P 19,4 cm

L 60 - 70 - 80 - 90 - 100 - 120 x H 75 cm
Disponibile con faretto - con presa interruttore

"Easy" mirror D 19.4 cm

L 60 - 70 - 80 - 90 - 100 - 120 x H 75 cm
Available with spotlight - with socket and switch

it — Le specchiere contribuiscono ad ampliare la profondità degli spazi, soprattutto negli ambienti bagno di piccole dimensioni.

en — Decorative and storage mirrors
The mirrors help to increase the depth of space, especially in small bathrooms.

Soluzioni luminose per specchi



Faretto led Fantasy
Disponibile cromo o nero
Potenza - Power 10W
Classe A+, Lumen 450, Kelvin 6000

Fantasy LED spotlight
Available in chrome or Nero



Faretto led Kira
Disponibile cromo o nero
Potenza - Power 5W
Classe A+, Lumen 250, Kelvin 6000

Kira LED spotlight
Available in chrome or Nero

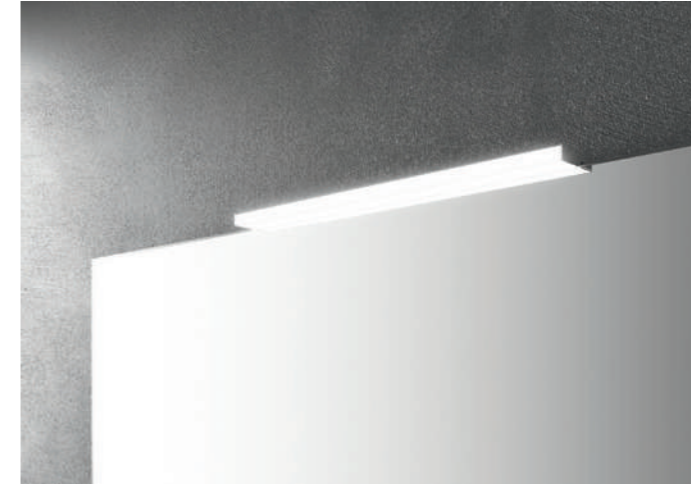

Faretto led Mirage
Disponibile cromo o nero
(non utilizzabile su specchiere contenitore Easy)

Mirage LED spotlight
Available in chrome or Nero
(not for use on Easy storage mirror units)

| Misura Side | L 60 | L 70 | L 80 | L 90 | L 100 | L 120 |
|-------------------|------|------|------|------|-------|-------|
| Potenza (W) Power | 15 | 20 | 20 | 25 | 25 | 30 |
| Classe Class | A++ | A++ | A++ | A++ | A++ | A++ |
| Lumen | 1135 | 1480 | 1480 | 1790 | 1790 | 2130 |
| Kelvin | 4000 | 4000 | 4000 | 4000 | 4000 | 4000 |

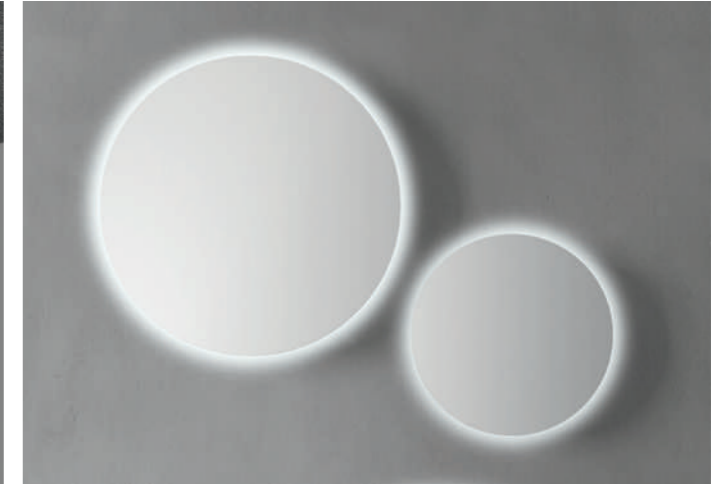

Luci Led per specchiera Disco
LED lights for "Disco" mirror

Ø 40 cm
Potenza - Power 9,6W
Classe A+, Lumen 794, Kelvin 4000

Ø 60 cm
Potenza - Power 9,6W
Classe A+, Lumen 1184, Kelvin 4000

Ø 80 cm
Potenza - Power 9,6W
Classe A+, Lumen 1581, Kelvin 4000

it — In bagno i punti luce sono fondamentali: faretti e luci a led aggiungono una funzione luminosa alle specchiere.

en — Bright mirror solutions
Light is essential in the bathroom: spotlights and LEDs can be used to add light to the mirrors.

Nobilitato effetto legno
Wood-effect melamine

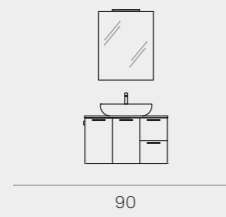

P 46 - 01 (page 10-11)
L 90 x P 46 cm

Scocca e frontale **Sable Beige**
con particolari bianco Neve opaco

Top unicolor
Pulpis Light sp. 3,8 cm

Lavabo "tutto Fuori" **Sky**
in mineralguss

Specchiera "Mini"
L 60 x H 75 cm

Faretto **Kira**

Portasciugamani laterale

Body and front **Sable Beige**
with matt Bianco Neve details

Unicolor top
Pulpis Light 3.8 cm thick

Sky countertop washbasin
in Mineralguss

"Mini" mirror
W. 60 x H. 75 cm

Kira spotlight

Side towel rail

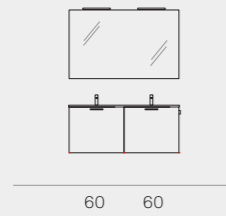

P 46 - 02 (page 14-15)
L 120 x P 46 cm

Scocca e frontale **Sable Marrone**

Lavabo consolle **Keope**
in mineralguss

Specchiera "Mini"
L 120 x H 75 cm

Faretto **Kira**

Portasciugamani laterale

Body and front **Sable Marrone**

Keope console washbasin
in Mineralguss

"Mini" mirror
W. 120 x H. 75 cm

Kira spotlight

Side towel rail



P 46 - 03 (page 16-17)
L 120 x P 46 cm

Scocca e frontale **Sable Marrone**

Top unicolor
Pulpis Dark sp. 3,8 cm

Lavabo "tutto fuori" **Thin 45**
in ceramica

Specchiera contenitore **Easy**

Faretto **Kira**

Body and front **Sable Marrone**

Unicolor top
Pulpis Dark 3.8 cm thick

Thin 45 countertop washbasin
in ceramic

Easy mirrored cupboard

Kira spotlight

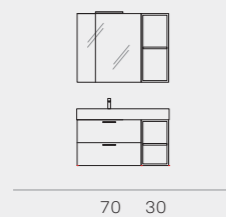

P 46 - 04 (page 20-21)
L 100 x P 46 cm

Scocca e frontale **Sable Bianco**

Lavabo consolle **Tube**
in ceramica

Specchiera contenitore **Easy**

Faretto **Kira**

Body and front **Sable Bianco**

Tube console washbasin
in ceramic

Easy mirrored cupboard

Kira spotlight



P 46 - 05 (page 22-23)
L 80 x P 46 cm

Scocca e frontale **Sable Beige**

Lavabo consolle
Just in ceramica

Specchiera "Disco" con luci led

Pensili a giorno in **Sable Beige**

Body and front **Sable Beige**

Console washbasin
Just in ceramic

"Disco" mirror with LED lights

Open wall units in **Sable Beige**



P 46 - 06 (page 26-27)
L 120 x P 46 cm + colonna / tall unit L 30 cm

Scocca e frontale **Chêne Naturel**
con particolari Bianco Neve

Lavabo consolle **Slim**
in ceramica

Specchiera contenitore **Easy**

Faretto **Fantasy**

Body and front **Chêne Naturel**
with Bianco Neve details

Slim console washbasin
in ceramic

Easy mirrored cupboard

Fantasy spotlight



P 46 - 07 (page 30-31)
L 60 + 30 + 60 x P 46/20,8 cm

Scocca e frontale **Sable Bianco**
con particolari Grigio chiaro opaco

Lavabo consolle **Figura**
in Solid Surface

Specchiere "Mini"
L 60 x H 75 cm

Faretto **Kira**

Body and front **Sable Bianco**
with matt Grigio Chiaro details

Figura console washbasin
in Solid Surface

"Mini" mirror
W. 60 x H. 75 cm

Kira spotlight

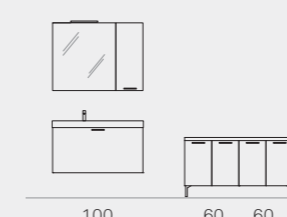

P 46 - 08 (page 34-35)
L 100 x P 46 cm + basi 60 + 60 cm

Scocca e frontale **Rovere Cortina**

Lavabo consolle **Just** in ceramica

Specchiera "Mini" L.70 x H.75 cm

Faretto **Mirage**

Basi laterali con top unicolor
Pulpis Light sp. 3,8 cm

Body and front **Rovere Cortina**

Just console washbasin in ceramic

Specchiera "Mini" L.70 x H.75 cm

Faretto **Mirage**

Side base units with Unicolor top
Pulpis Light 3.8 cm thk

Nobilitato colore opaco

Melamine matt colour

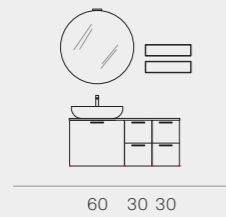

P 46 - 09 (page 44-45)
L 120 x P 46 cm

Scocca e frontale
Grigio medio opaco

Top unicolor
Pulpis Light sp. 3,8 cm

Lavabo "tutto Fuori" **Sky**
in mineralguss

Specchiera "**Disco**" Ø 60 cm

Pensili in metallo L 50 cm

Body and front
Matt **Grigio Medio**

Unicolor top
Pulpis Light 3.8 cm thick

Sky countertop washbasin
in Mineralguss

"**Disco**" mirror Ø 60 cm

Metal wall units W. 50 cm

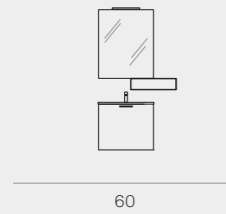

P 46 - 10 (page 48-49)
L 60 x P 46 cm

Scocca e frontale **Azzurro opaco**

Lavabo consolle **Keope**
in mineralguss

Specchiera "**Mini**"
L 60 x H 75 cm

Faretto **Kira**

Pensile in metallo L 50 cm

Body and front in matt **Azzurro**

Keope console washbasin
in Mineralguss

"**Mini**" mirror
W. 60 x H. 75 cm

Kira spotlight

Metal wall unit W. 50 cm

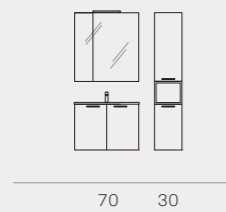

P 46 - 11 (page 50-51)
L 70 + 30 x P 46 cm

Scocca e frontale **Grigio chiaro**
con particolari **Sable Beige**

Lavabo consolle **Slim**
in ceramica

Specchiera contenitore **Easy**

Faretto **Fantasy**

Body and front **Grigio Chiaro**
with **Sable Beige** details

Slim console washbasin
in ceramic

Easy mirrored cupboard

Fantasy spotlight

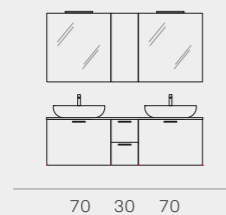

P 46 - 12 (page 54-55)
L 170 x P 46 cm

Scocca e frontale **Grigio scuro**

Top unicolor
Pulpis Light sp. 3,8 cm

Lavabo "tutto fuori" **Thin 55**
in ceramica

Specchiera contenitore **Easy**

Faretto **Fantasy**

Body and front **Grigio Scuro**

Unicolor top
Pulpis Light 3.8 cm thick

Thin 55 countertop washbasin
in ceramic

Easy mirrored cupboard

Fantasy spotlight

Nobilitato effetto legno
Wood-effect melamine



Chêne naturel

Rovere cortina

Sable bianco

Sable beige



Sable marrone

Nobilitato colore opaco
Melamine matt colour

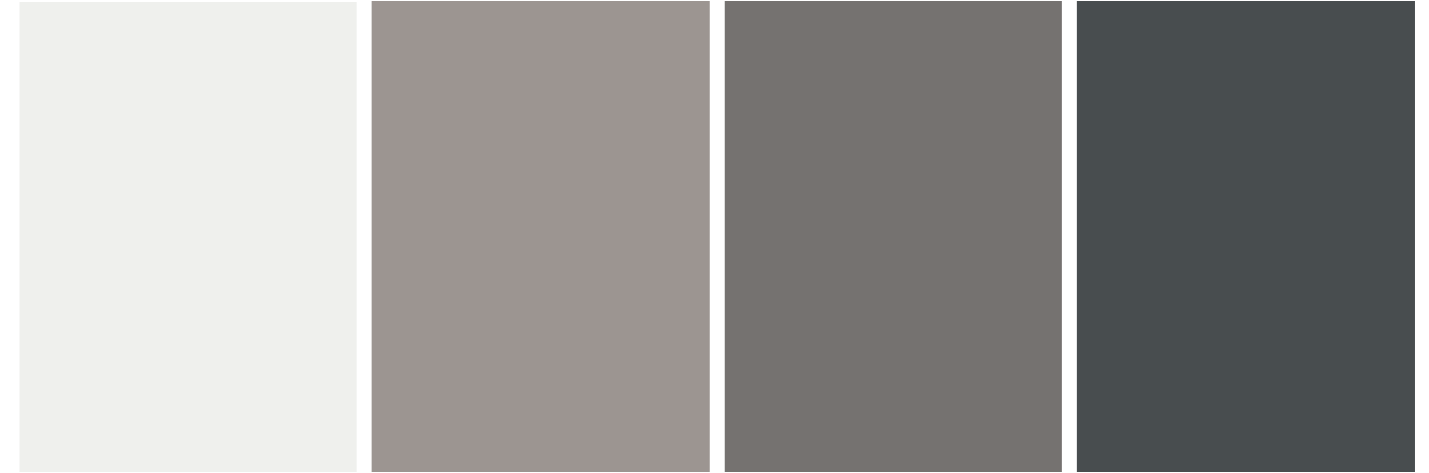

Bianco neve

Grigio chiaro

Grigio medio

Grigio scuro

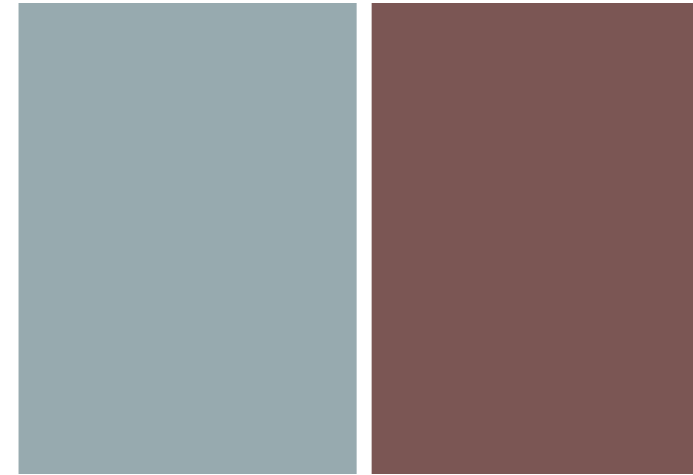

Azzurro

Rosso cardinale

Design & Coordination
Arcom

Art direction Graphic Design
Lokomotiv

Photo/Rendering
Indoor

Art direction Photo & Styling
Rossi & Co.

Colour separation
Luce

Print
OGM

June 2020

ak
bathstyle

By ARCOM srl

33070 Tamai di Brungera / PN – Italy

Viale Europa 4 – z.i del Camol

Tel. +39.0434.1852300

+39.0434.1573020 / +39.0434.613619

Fax. +39.0434.608137

e.mail: info@arcombagno.com

www.arcombagno.com

**ATMA**
INDUSTRIE DEL MOBILE

e-mail: gruppoatma@gruppoatma.it

<http://www.gruppoatma.it>