

*i am*  
**your  
favourite**

Caminetti a gas 2022/ 2023

i am  since 1754

### Gli specialisti del fuoco dal 1754

Cosa c'è di più accogliente di un fuoco acceso? Sia che abbiate un gusto classico o che vi piacciono le linee pulite: da DRU troverete il caminetto a gas che fa per voi. Grazie alla nostra storia e alla nostra competenza - abbiamo oltre 270 anni di esperienza in fatto di comfort, durata e sicurezza del calore in casa - vi offriamo sempre la migliore soluzione. La nostra innovativa maestria artigianale la ritroviamo in ogni modello della nostra serie di caminetti a gas moderni. Tutti questi modelli soddisfano i requisiti più severi in materia di durata, rendimento, emissioni, sicurezza e facilità d'uso. Perché noi continuiamo a migliorarci, anno dopo anno. Se siete alla ricerca di un calore d'atmosfera, allora scegliete DRU.



#### Sostenibilità

Per DRU la soddisfazione dei clienti e l'efficienza vanno di pari passo con la compatibilità ambientale e la sicurezza.



#### Ambizione estrema

Noi diciamo sempre quello che facciamo e facciamo sempre quello che diciamo. Siamo ambiziosi e critici e continuiamo a migliorarci.



#### Facilità d'uso

La comodità per l'utente finale è sempre al primo posto. Il nostro obiettivo: lavorare su prodotti intelligenti, innovativi e confortevoli.



#### Innovazione continua

Curiosi, desiderosi d'imparare e amanti del progresso, ecco quello che siamo.

Andiamo avanti solo continuando a svilupparci.



#### Guarda i nostri caminetti accesi

Scansiona i codici QR sui caminetti e guarda come brucia ogni caminetto.



*i am*  
**consciously  
comfortable**

Calore, atmosfera e comfort? Questo è proprio quello che ti offro. Mettiti dove vuoi, e io ti garantirò il fuoco più bello. Mi puoi comandare semplicemente dal divano e non ti serve la legna. Quindi totalmente sicuro, semplice e pulito. E lo sapevi che sono anche a prova di futuro? In combinazione con il biogas o con il bio-propano sono un'alternativa sostenibile. In breve: ti offro solo dei vantaggi e sarai certo che starò anche bene a casa tua!

## indice

### A proposito di DRU

Stile di vita	4
Ambiente e consumi	6
Interni e pannelli a parete	8
Innovazioni	10
Gas e sostenibilità	12

### Caminetti DRU

Caminetti Maestro	14
Caminetti Metro 34	
Caminetti Lugo 50	
Caminetti Cosmo	54
Caminetti Paco	58
Caminetti indipendenti e sospesi	62

### Caminetti DRU Global

<i>Combustione aperta (CF)</i>	
Caminetti Global	72
<i>Combustione chiusa (BF)</i>	
Caminetti Global	72

### Dettagli tecnici

Possibilità d'installazione	84
Cornici	86
Comando e accessori	88
Disegni	90
Specifiche tecniche	96

# come mi adatto alla tua vita?

Una buona idea per scegliermi per il tuo soggiorno. Infatti tu non vuoi solo calore e comfort, ma anche atmosfera e intimità nella tua casa. Io esisto in tanti tipi e dimensioni.

Scopri come posso adattarmi meglio a casa tua!



### **Atmosfera e calore**

Desideri un nuovo caminetto per il calore oppure pensi che sia importante creare una certa atmosfera? La base dei tuoi desideri definisce il primo passo verso il tuo nuovo caminetto a gas.



### **Un design adatto a tutti**

Ti piace un design classico oppure elegante e moderno? Da DRU troverai dei caminetti a gas per tutti i gusti e per ogni spazio. Dai caminetti incassati a quelli indipendenti, con vetro su uno, due o tre lati oppure con una versione a vista.

Sei tu a scegliere!

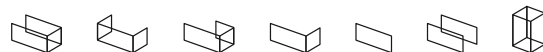

*La nostra gamma di caminetti*



### **Spazio e potenza**

La potenza di un camino a gas dipende dallo spazio dove il camino viene installato, dal livello di isolamento della casa e dall'utilizzo del camino: ad esempio, lo accendi tutti i giorni, o soltanto nel weekend? In questo modo si potrà fare la scelta corretta in base alle proprie esigenze abitative.

### **Lasciati ispirare**

Per ottenere una consulenza "su misura" alle vostre necessità e per poter visionare da vicino i diversi modelli disponibili, affidatevi ad un rivenditore autorizzato DRU più vicino a voi. In questo modo avrete la possibilità di effettuare la scelta più accurata del vostro camino, garantendo soddisfazioni, nel corso degli anni a venire.

# ambiente e calore su misura

Meno consumo, meno calore, ma sempre tanta atmosfera.  
Che te ne pare? Io sono Eco Wave e risolvo tutto per te! Oppure  
puoi farlo da solo, perché puoi regolare il consumo e le fiamme.  
Grazie a me puoi godere tutto l'anno di fiamme naturali nel tuo  
caminetto pieno d'atmosfera. Semplice, elegante ed efficiente.



## Eco Wave

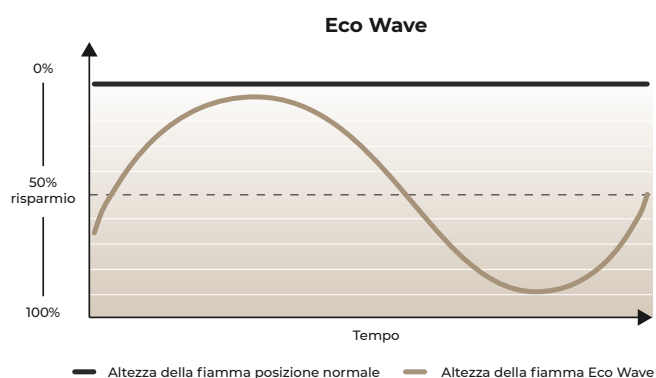

## Controllo sulla tua energia

Grazie alla nostra tecnologia esclusiva Eco Wave all'interno dei bruciatori del gas, riduci i tuoi consumi di gas fino al 50%, senza compromettere l'atmosfera nella tua casa. Quindi puoi continuare a godere, per tutto l'anno, di una bella fiamma e inoltre hai il controllo totale sui tuoi consumi. La potenza termica, le fiamme e il consumo li regoli facilmente tramite l'app o il comando a distanza di DRU. Qui puoi scegliere fra due differenti livelli di risparmio oppure creare un tuo livello di risparmio personalizzato. Quindi molto sostenibile!



## Eco Glow

# 100% atmosfera, 0% calore

Preferisci non avere calore, ma non vuoi rinunciare all'atmosfera? Allora passa alla funzione Eco Glow. Con Eco Glow avrai un camino acceso grazie al letto incandescente. Questo letto incandescente naturale non produce calore ed è regolabile separatamente. Utilizzando l'app o il comando a distanza sarai tu a definire l'atmosfera di casa tua.



# una atmosfera unica

Non tutti abbiamo gli stessi gusti. E questa è una buona cosa, perché puoi abbinarti all'infinito. Preferisci un rivestimento interno nero ed elegante, oppure un look più robusto? E che aspetto devono avere i pannelli della parete? Da DRU potrai assemblarmi da solo, fino nei più piccoli dettagli.

## Scegli il tuo design

In quasi tutti i nostri caminetti a gas puoi scegliere il rivestimento interno\*. Puoi scegliere fra 6 differenti design: nero, ceraglass, vetro matt, rib cas, classico pietra (DRU) e classico pietra (DRU Global). Ogni design è qualcosa di diverso per i tuoi interni. La versione nera è elegante e si adatta perfettamente in un soggiorno moderno. Ceraglass ha un bell'aspetto a specchio che creerà una maggiore profondità nel camino. Rib cast è il nostro rivestimento interno più robusto. Infine puoi scegliere tra 2 tipi di pietra classica, ognuna con il proprio look classico.

*\* Disponibile su una parte della gamma.*



Nero



Ceraglass

Vetro matt

Rib cast

Classico  
pietra (DRU)

Classico pietra  
(DRU Global)





## Completa il caminetto con dei pannelli da parete

Anche l'aspetto esterno del caminetto lo puoi definire tu. Con i nostri pannelli da parete rib cast\* il tuo caminetto si adatterà ancora meglio ai tuoi interni. I pannelli da parete hanno una larghezza di circa 30 cm. L'altezza dipende dal tipo di caminetto e viene definita in base a questo dettaglio.

*\* Disponibile su una parte della gamma.*





Scopri i dettagli sul vetro  
Clear View  
Scansiona il codice QR.



Vetro Clear View

# vista perfetta

La vista perfetta sulle mie fiamme inizia ovviamente dalla qualità del vetro. Preferisci un vetro antiriflesso oppure no? E come lo mantieni pulito? I nostri produttori hanno per fortuna pensato a tutto così potrai goderti indisturbato.

## Vista super nitida della fiamma

Una buona vista sulle fiamme significa godersi appieno il proprio caminetto a gas acceso. Per questo da DRU puoi scegliere il vetro Clear View\*: un vetro antiriflesso che ti garantisce una vista ottimale sulla fiamma. Questo vetro è particolarmente adatto per i locali con poca luce diretta del sole oppure in interni dai colori scuri.

*\* Disponibile su quasi tutta la gamma*



Easy release door system

## pulizia immediata

Molti dei nostri caminetti a gas sono dotati di una pratica porta a ribalta. Facile da aprire senza particolari sforzi, ideale per una pulizia rapida dei vetri e per la manutenzione annuale da parte di un tecnico.

- Apertura diretta senza viti o sforzi particolari
- Blocco porta invisibile
- Cornici invisibili per una superficie più grande del vetro e una visione indisturbata delle fiamme
- Vetro da bordo a bordo senza saldatura per i modelli a 2 e 3 lati
- Completamente ermetico: una combustione sicura e ottimale



Scopri maggiori dettagli sul sistema  
Easy release door

Scansiona il codice QR.

# per ogni tipo di gas

Durante la progettazione di caminetti e stufe ad alta efficienza energetica, i miei progettisti non guardano solo al design.

Essi garantiscono anche la nostra più grande flessibilità.

Ecco perché siamo adatti per differenti tipi di gas...

e quindi per ogni tipo di abitazione!

## Perché scegliere ancora il gas?

Il gas negli ultimi anni è un combustibile molto discusso. A causa degli sviluppi internazionali i prezzi del gas aumentano. E sempre più (nuove) abitazioni non hanno più un allacciamento fisso per il gas. Ma lo sapevi che un caminetto a gas è ancora una scelta molto sostenibile e a prova di futuro? Anche se non hai nessun attacco del gas come avviene in alcuni paesi. Ti portiamo con noi a scoprire i vantaggi di un caminetto a gas DRU.

### Differenti tipi di gas

I caminetti a gas DRU sono perfettamente adatti per differenti tipi di gas. Ovviamente per il gas naturale, ma anche per tutti i tipi di gas in bombola sostenibili, come il biogas (metano e gpl). Il biogas è un gas rinnovabile prodotto da rifiuti e materiali di scarto e oli vegetali. Quindi si tratta di un tipo di gas sostenibile e un'alternativa ecologica al gas naturale. In questo modo utilizzi energia rinnovabile ed eviti l'uso di combustibili fossili. Inoltre i caminetti a gas DRU sono già pronti per essere utilizzati con una buona percentuale di miscela a base di idrogeno.

### Molto efficiente

Un caminetto a gas è una fonte di riscaldamento molto efficiente. Si riscalda solo il locale dove si sta e non tutte le altre camere. Ed è per questo che i caminetti a gas DRU hanno una combustione particolarmente efficiente. Quasi tutto il calore (quasi il 90%) entra direttamente nel soggiorno. Così si ha poca dispersione di calore. E sei tu ad avere il controllo completo su questo calore. Ad esempio, preferisci avere meno calore, ma vuoi comunque l'atmosfera? Allora passa alle funzioni esclusive presenti sui nostri caminetti a gas, come Eco Wave o Eco Glow. Questo significa goderne in modo consapevole!

### Pronto per il futuro

Magari hai un attacco del gas, ma vorresti eliminare il gas fra qualche anno. Con un caminetto a gas DRU sei sempre in prima fila. Anche dopo l'acquisto hai la possibilità di passare a un altro tipo di gas, come, ad esempio il bio gas o propano. In questo modo sei tu a decidere se continuare a usare il gas naturale come fonte di riscaldamento. Inoltre i caminetti a gas DRU sono pronti ad essere miscelati fino al 20% con l'idrogeno. Se la tua rete del gas è pronta per farlo, lo siamo anche noi!



*Tutti i caminetti a gas DRU sono dotati del sistema VBS. Questo sistema permette di garantire che tutti i camini continuino a funzionare nonostante le diverse composizioni dei differenti tipi di gas. Così sarai sicuro di avere degli interni caldi e accoglienti per gli anni a venire!*

*In questa brochure sono rappresentate solo le immagini di caminetti a gas che funzionano con gas naturale. Se si utilizza un altro tipo di gas, il colore della fiamma potrebbe cambiare.*



# *i am* maestro

Io sono il modello più esclusivo nella collezione di caminetti a gas DRU.

Poiché sono disponibile in differenti forme e dimensioni, mi adatto in quasi tutti i tipi di

interni. E grazie alla mia tecnologia di combustione unica, sei sempre sicuro di avere il

fuoco più bello con delle fiamme naturali. Che lusso!



## **XTU a 3 lati**

75XTU *Eco Wave*



## **3 lati**

60/3 *Eco Wave*

60/3 Tall *Eco Wave*

80/3 *Eco Wave*

105/3 *Eco Wave*



## **2 lati**

60/2 *Eco Wave*

60/2 Tall *Eco Wave*

80/2 *Eco Wave*

105/2 *Eco Wave*



## **Frontale**

60 *Eco Wave*

60 Tall *Eco Wave*

75 *Eco Wave*

75 Tall *Eco Wave*

100 *Eco Wave*



## **Tunnel**

75 Tunnel *Eco Wave*

75 Tunnel Tall *Eco Wave*

## fiamma



### Dynamic Flame Burner®

Fiamme vive e naturali costruite come un vero fuoco a legna. I doppi bruciatori garantiscono una fiamma molto alta e profonda.

## comando

Comanda il tuo camino con estrema facilità grazie al **comando a distanza** fornito di serie.



Utilizza la nostra pratica **app gratuita** per il controllo totale del tuo caminetto.



**Facile da accoppiare** al tuo sistema di Domotica.



Nero

Vetro matt

Ceraglass

Rib cast

Classico pietra (DRU)

## comodo da sapere



### Easy release door system

Con l'Easy release door system non devi fare alcuno sforzo per aprire il tuo caminetto. Inoltre questa comoda porta a ribalta è l'ideale per la pulizia del tuo caminetto.



### VBS

Tutti i caminetti a gas DRU sono dotati del sistema VBS. Questo sistema permette di garantire che il tuo caminetto continui a funzionare nonostante la composizione dei differenti tipi di gas. Non hai un allacciamento del gas fisso con gas naturale? Nessun problema. I nostri caminetti funzionano anche con butano, biogas o bio-propano.



### Direct flue

Ti offriamo la libertà di installare il tuo caminetto dove preferisci. Ad esempio, puoi far passare lo scarico del tuo caminetto attraverso la parete. Lo scarico si collega direttamente al caminetto e esce all'esterno con una curva di 90 gradi.

## scegli l'aspetto che preferisci

### Interni

Scegli il rivestimento interno adatto al tuo arredamento.

### Pannelli a parete

Con i nostri pannelli a parete rib cast rendi completo il look del tuo caminetto.



### Finestra di vetro

Scegli il nostro vetro Clear View esclusivo: un vetro antiriflesso che ti garantisce una vista ottimale sulla fiamma.

### Vassoio del bruciatore

I caminetti Maestro includono un set di legna realistico di colore marrone.



Set di legna marrone



### Cornici

I nostri caminetti sono dotati di serie di una cornice, ma sono disponibili anche senza cornice o con delle cornici personalizzate.



### PowerVent®

PowerVent® è un sistema di scarico concentrico plug & play con ventilatore. La flessibilità di questo sistema di scarico consente di installare un caminetto a gas in quasi tutte le situazioni abitative.

## sostenibilità



### Eco Wave

Riduci i tuoi consumi di gas fino al 50% senza compromettere l'atmosfera nella tua casa.



### Eco Glow

Preferisci non avere calore, ma non vuoi rinunciare all'atmosfera. Allora passa al letto incandescente illuminato.



## Maestro 75XTU *Eco Wave*

### Proprietà

- Funzione di divisorio elegante e pieno d'atmosfera
- Installabile anche galleggiante o a mezza altezza



### Gamma di potenza

Gas naturale G20 **1,2 - 8,8 kW**  
Gas naturale G25,3 **1,2 - 8,4 kW**  
GPL G31 **1,9 - 9,5 kW**

### Grado di efficienza

93,3 %

**A**







Scansiona questo codice QR  
per vedere un caminetto acceso.



## Maestro 60/3 Eco Wave

### Proprietà:

- Molto bello con interni in ceraglass
- Adatto anche a locali di piccole dimensioni

### Scegli il tuo formato:

(per le dimensioni esatte vedere a pag. 90)

60/3

60/3  
TALL

80/3

105/3

### Gamma di potenza

Gas naturale G20 **1,9 - 7,2 kW**

Gas naturale G25,3 **1,6 - 6,8 kW**

GPL G31 **1,1 - 7,3 kW**

### Grado di efficienza

94,3 %

A



Scansiona questo codice QR  
per vedere un caminetto acceso.



Scansiona questo codice QR per vedere un caminetto acceso.



## Maestro 60/3 Tall Eco Wave

### Proprietà:

- Finestra alta moderna
- Molte opzioni disponibili per una finitura di lusso

### Scegli il tuo formato:

(per le dimensioni esatte vedere a pag. 90)

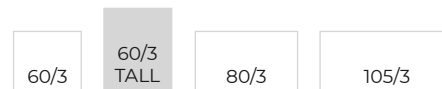

### Gamma di potenza

Gas naturale G20 **1,9 - 7,2 kW**  
 Gas naturale G25.3 **1,6 - 6,8 kW**  
 GPL G31 **1,1 - 7,3 kW**

### Grado di efficienza

96,3 %

**A**





## Maestro 80/3 Eco Wave

### Proprietà:

- Fiamma sempre visibile
- Ampia gamma di potenza

### Scegli il tuo formato:

(per le dimensioni esatte vedere a pag. 90)



### Gamma di potenza

Gas naturale G20 **1,4 - 9,0 kW**  
Gas naturale G25.3 **1,3 - 8,6 kW**  
GPL G31 **1,3 - 7,7 kW**

### Grado di efficienza

93,0 %

A





Scansiona questo codice QR per vedere un caminetto acceso.



Scansiona questo codice QR per vedere un caminetto acceso.



## Maestro 105/3 Eco Wave

### Proprietà:

- Gioco di fiamme completo naturale
- Incassabile con eleganza e senza telaio

### Scegli il tuo formato:

(per le dimensioni esatte vedere a pag. 90)



### Gamma di potenza

Gas naturale G20 **2,5 - 10,3 kW**  
 Gas naturale G25.3 **2,1 - 9,8 kW**  
 GPL G31 **2,6 - 10,5 kW**

### Grado di efficienza

91,2 %

A





## Maestro 60/2 Eco Wave

### Proprietà:

- Bel caminetto angolare per locali più piccoli
- Grado di efficienza molto elevato

### Scegli il tuo formato:

(per le dimensioni esatte vedere a pag. 90)

60/2

60/2  
TALL

80/2

105/2

### Gamma di potenza

Gas naturale G20 **1,9 - 7,2 kW**

Gas naturale G25.3 **1,6 - 6,8 kW**

GPL G31 **1,1 - 7,3 kW**

### Grado di efficienza

94,3 %

A



Scansiona questo codice QR  
per vedere un caminetto acceso.



Scansiona questo codice QR per vedere un caminetto acceso.

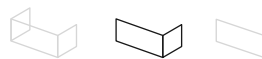

## Maestro 60/2 Tall *Eco Wave*

### Proprietà:

- Finestra alta moderna
- Adatto anche a locali di piccole dimensioni

### Scegli il tuo formato:

(per le dimensioni esatte vedere a pag. 90)



### Gamma di potenza

Gas naturale G20 **1,9 - 7,2 kW**  
 Gas naturale G25.3 **1,6 - 6,8 kW**  
 GPL G31 **1,1 - 7,3 kW**

### Grado di efficienza

96,3 %

**A** →





## Maestro 80/2 Eco Wave

### Proprietà:

- Esperienza ottimale del fuoco
- Incassabile con eleganza e senza telaio

### Scegli il tuo formato:

(per le dimensioni esatte vedere a pag. 90)



### Gamma di potenza

Gas naturale G20 **1,4 - 9,0 kW**

Gas naturale G25.3 **1,3 - 8,6 kW**

GPL G31 **1,3 - 7,7 kW**

### Grado di efficienza

93,0 %

A

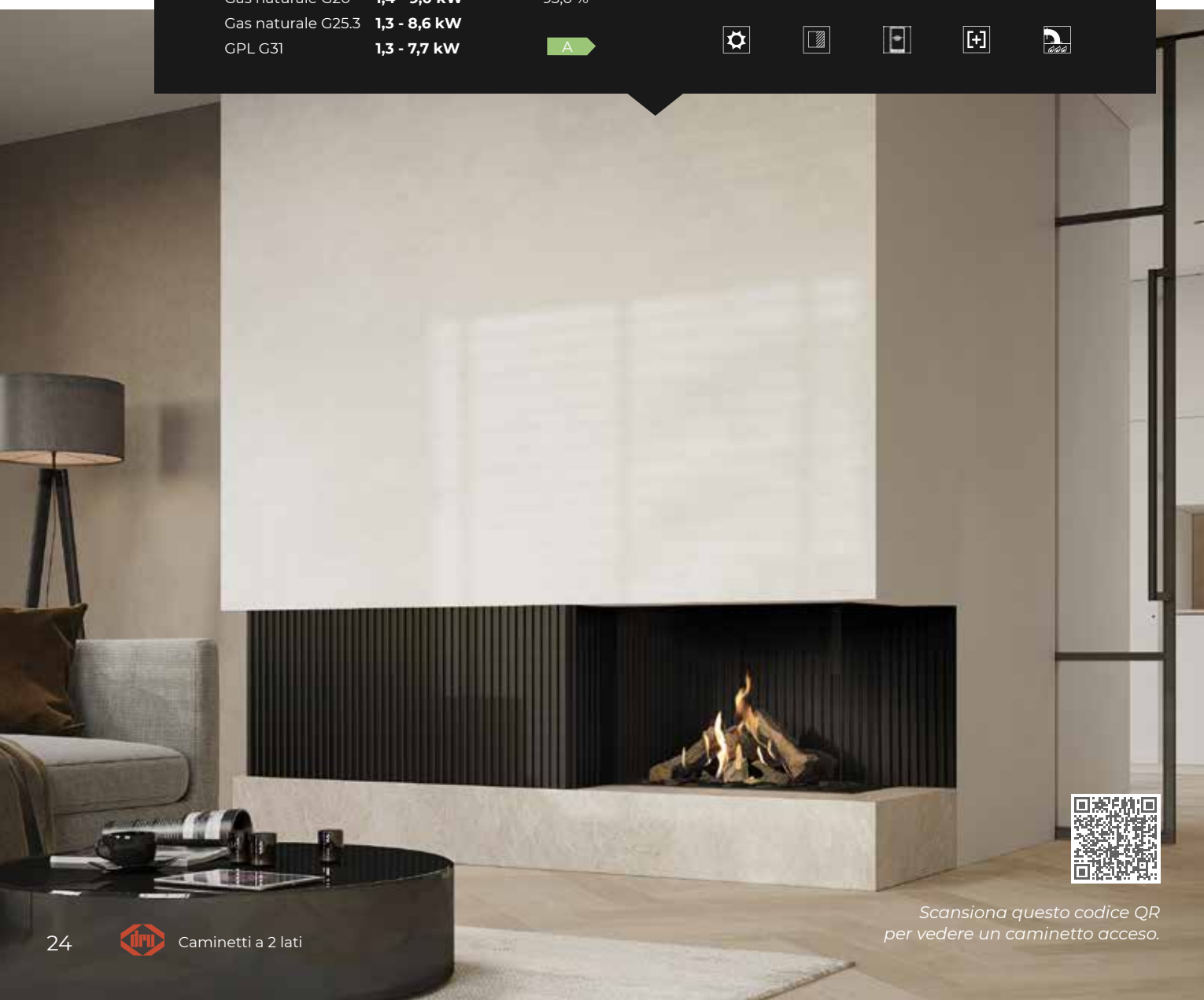

Scansiona questo codice QR  
per vedere un caminetto acceso.





## Maestro 105/2 Eco Wave

### Proprietà:

- Perfetto come parte di un mobiletto tv
- Installabile sospeso

### Scegli il tuo formato:

(per le dimensioni esatte vedere a pag. 91)

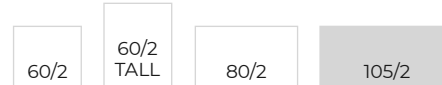

### Gamma di potenza

Gas naturale G20 **2,5 - 10,3 kW**  
Gas naturale G25.3 **2,1 - 9,8 kW**  
GPL G31 **2,6 - 10,5 kW**

### Grado di efficienza

91,2 %

A

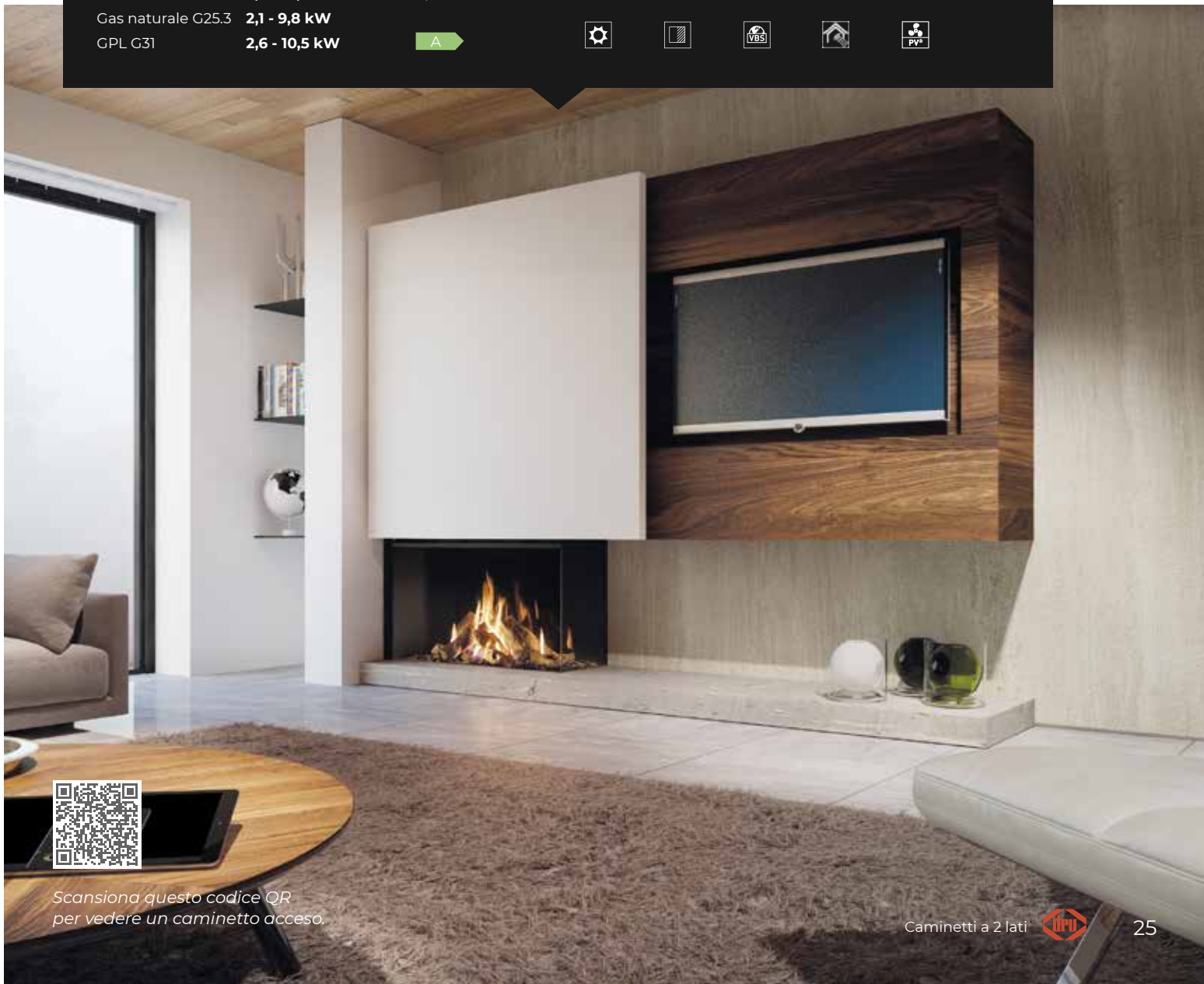

Scansiona questo codice QR  
per vedere un caminetto acceso.



## Maestro 60 *Eco Wave*

### Proprietà:

- Perfetto per locali più piccoli come la cucina
- Ampia vista sulle fiamme grazie all'uso ridotto di cornici

### Scegli il tuo formato:

(per le dimensioni esatte vedere a pag. 91)



### Gamma di potenza

Gas naturale G20 **1,9 - 7,5 kW**

Gas naturale G25.3 **1,6 - 6,8 kW**

GPL G31 **1,1 - 7,3 kW**

### Grado di efficienza

94,3 %

**A**



Technical specifications and features summary for the Maestro 60 Eco Wave fireplace, including power range, efficiency, and various icons.

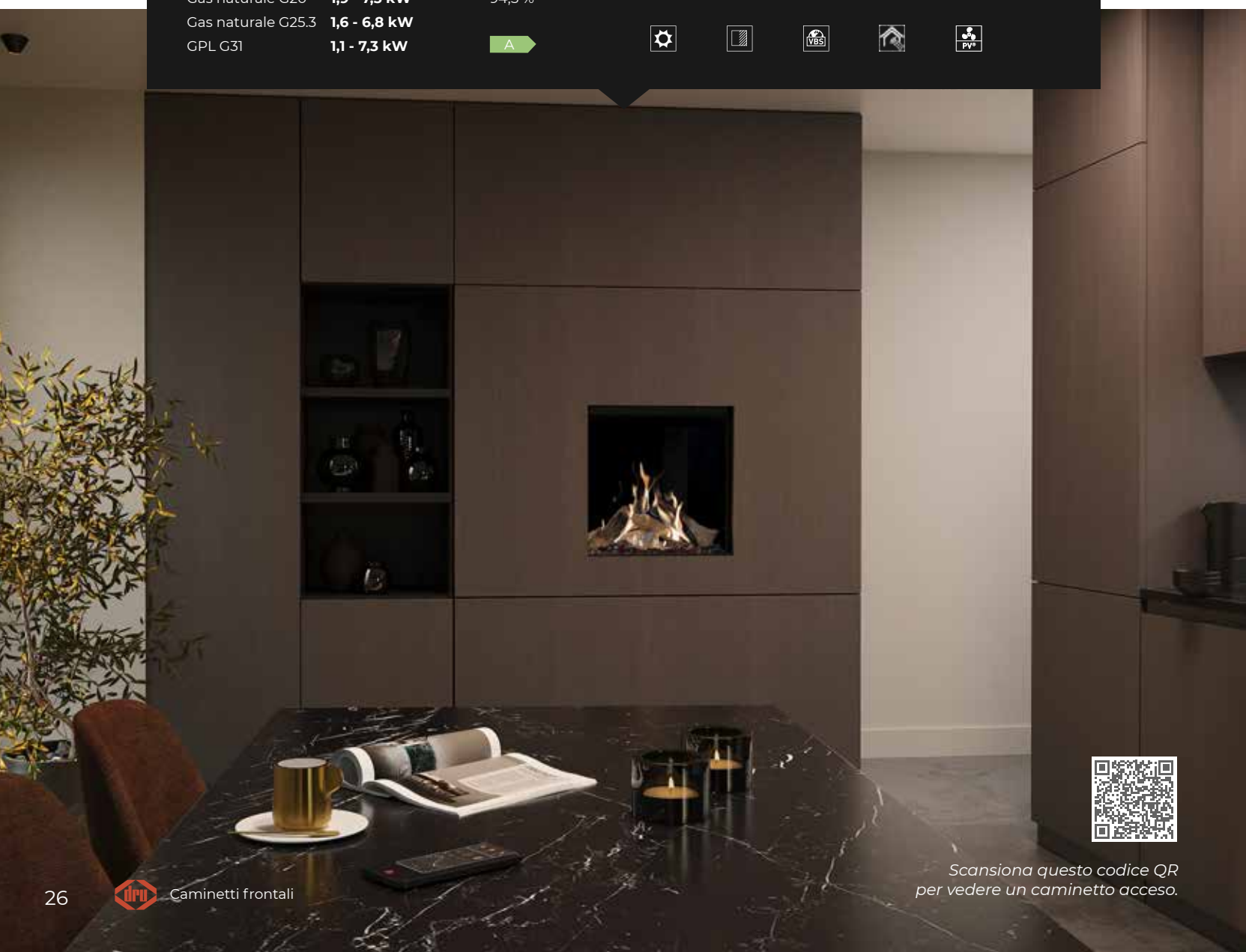

Scansiona questo codice QR  
per vedere un caminetto acceso.



Scansiona questo codice QR per vedere un caminetto acceso.



## Maestro 60 Tall *Eco Wave*

### Proprietà:

- Aspetto verticale moderno
- Adatto anche a locali di piccole dimensioni

### Scegli il tuo formato:

(per le dimensioni esatte vedere a pag. 91)

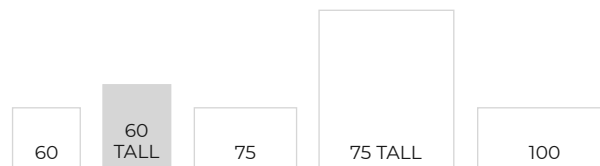

### Gamma di potenza

Gas naturale G20 **1,9 - 7,2 kW**  
 Gas naturale G25.3 **1,6 - 6,8 kW**  
 GPL G31 **1,1 - 7,3 kW**

### Grado di efficienza

96,3 %

**A** →





## Maestro 75 Eco Wave

### Proprietà:

- Sostituito ad efficienza energetica di un normale caminetto
- Ampia gamma di potenza

### Scegli il tuo formato:

(per le dimensioni esatte vedere a pag. 91)

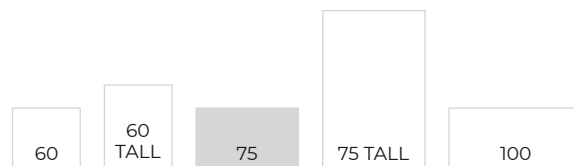

### Gamma di potenza

Gas naturale G20 **1,3 - 9,0 kW**

Gas naturale G25.3 **1,2 - 8,6 kW**

GPL G31 **1,3 - 7,9 kW**

### Grado di efficienza

89,0 %

**A** →



Scansiona questo codice QR  
per vedere un caminetto acceso.



## Maestro 75 Tall *Eco Wave*

### Proprietà:

- Ampia vista sulle fiamme
- Installabile anche indipendente nella stanza

### Scegli il tuo formato:

(per le dimensioni esatte vedere a pag. 91)

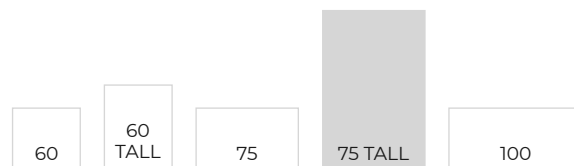

### Gamma di potenza

Gas naturale G20 **1,7 - 9,2 kW**

Gas naturale G25.3 **1,5 - 8,7 kW**

GPL G31 **1,5 - 8,2 kW**

### Grado di efficienza

91,0 %

A



Scansiona questo codice QR  
per vedere un caminetto acceso.



## Maestro 100 *Eco Wave*

### Proprietà

- Grande esperienza del fuoco
- Molte opzioni disponibili per una finitura di lusso

### Scegli il tuo formato:

(per le dimensioni esatte vedere a pag. 91)

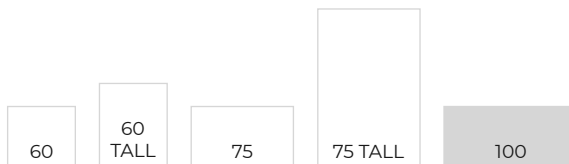

### Gamma di potenza

Gas naturale G20 **2,3 - 10,0 kW**  
Gas naturale G25.3 **1,9 - 9,3 kW**  
GPL G31 **2,3 - 10,2 kW**

### Grado di efficienza

92,1 %

**A**





Scansiona questo codice QR  
per vedere un caminetto acceso.



## Maestro 75 Tunnel *Eco Wave*

### Proprietà:

- Caminetto a tunnel, trasparente e pieno d'atmosfera
- Per godersi un bel fuoco da 2 camere

### Scegli il tuo formato:

(per le dimensioni esatte vedere a pag. 91)

75

75 TALL

### Gamma di potenza

Gas naturale G20 **1,7 - 9,1 kW**  
Gas naturale G25.3 **1,5 - 8,5 kW**  
GPL G31 **1,9 - 9,5 kW**

### Grado di efficienza

93,0 %

A

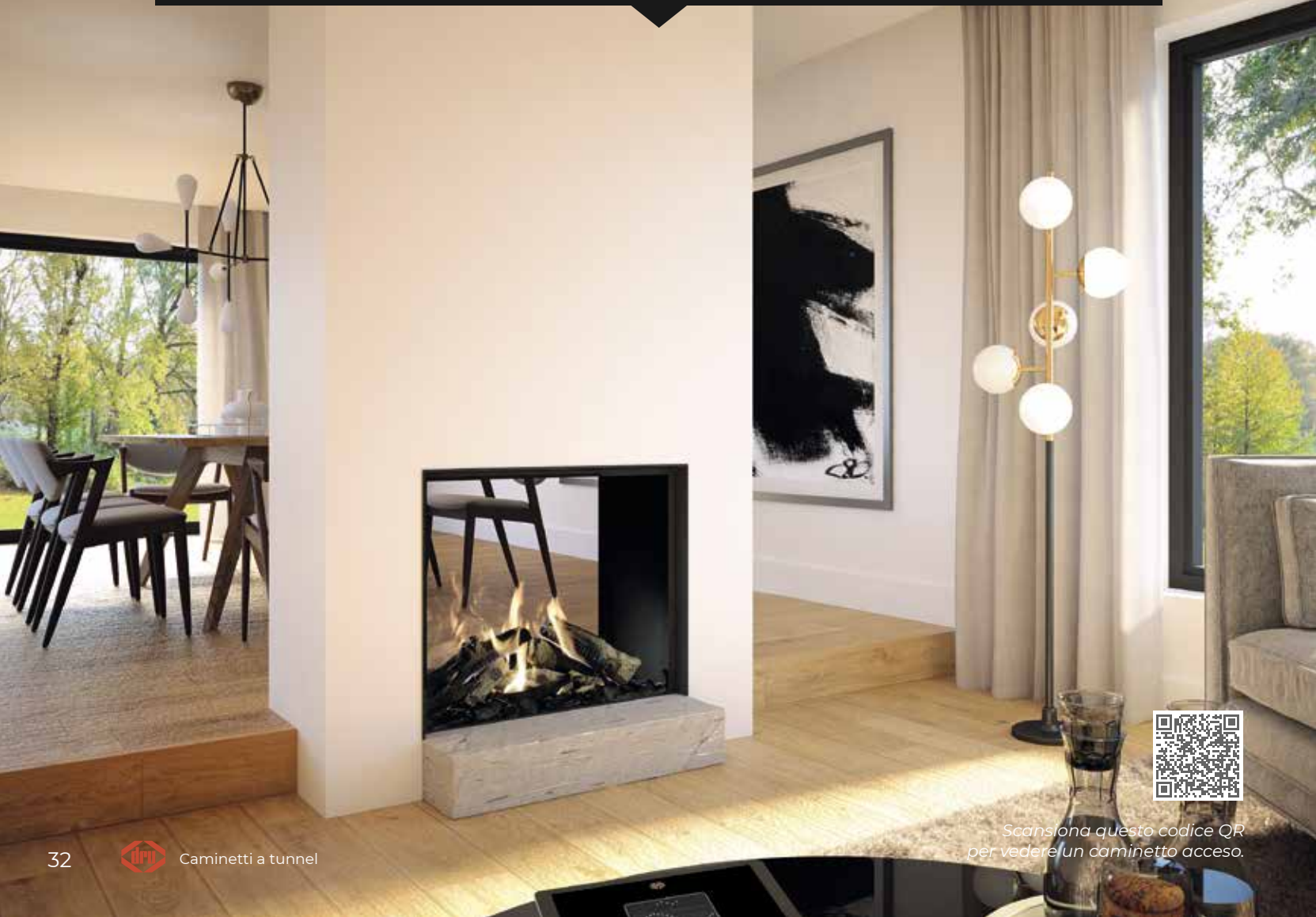

Scansiona questo codice QR  
per vedere un caminetto acceso.





Scansiona questo codice QR per vedere un caminetto acceso.



## Maestro 75 Tunnel Tall *Eco Wave*

### Proprietà:

- Divisorio della camera con vetrata alta
- Ottimale esperienza del fuoco in 2 camere

### Scegli il tuo formato:

(per le dimensioni esatte vedere a pag. 91)

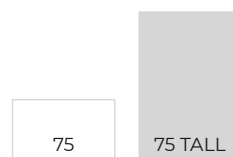

### Gamma di potenza

Gas naturale G20 **2,0 - 10,2 kW**  
 Gas naturale G25.3 **1,7 - 9,5 kW**  
 GPL G31 **2,0 - 10,0 kW**

### Grado di efficienza

92,0 %

**A**



# *i am* metro

Vuoi un'atmosfera ancora più bella nel tuo soggiorno? Allora scegli me! Io sono un pò più grande del resto della mia famiglia e quindi offro ancora più accoglienza in casa. E lo sapevi che io con i miei bruciatori a zig-zag posso creare delle fiamme ancora più ampie e profonde? Massimo godimento del tuo caminetto!



## **XTU a 3 lati**

100XTU *Eco Wave*



## **XTL a 3 lati**

100XTL *Eco Wave*  
130XTL *Eco Wave*



## **3 lati**

100XT/3 *Eco Wave*  
130XT/3 *Eco Wave*



## **2 lati**

100XT/2 *Eco Wave*  
130XT/2 *Eco Wave*



## **Frontale**

80XT *Eco Wave*  
100XT *Eco Wave*  
130XT *Eco Wave*  
150XT *Eco Wave*  
200XT *Eco Wave*



## **Tunnel**

80XT Tunnel *Eco Wave*  
100XT Tunnel *Eco Wave*  
130XT Tunnel *Eco Wave*  
150XT Tunnel *Eco Wave*  
200XT Tunnel *Eco Wave*

# fiamma



## Vario Burner

Grazie alle fiamme alte e ampie a forma di zigzag, il fuoco riempie l'intero caminetto.

# comando

Comanda il tuo camino con estrema facilità grazie al **comando a distanza** fornito di serie



Utilizza la nostra pratica **app gratuita** per il controllo totale del tuo caminetto.



**Facile da accoppiare** al tuo sistema di Domotica



Nero

Ceraglass

## comodo da sapere



### Easy release door system

Con l'Easy release door system non deve fare alcuno sforzo per aprire il tuo caminetto. Inoltre questa comoda porta a ribalta è l'ideale per la pulizia del tuo caminetto.



### PowerVent®

PowerVent® è un sistema di scarico concentrico plug & play con ventilatore. La flessibilità di questo sistema di scarico consente di installare un caminetto a gas in quasi tutte le situazioni abitative.



### Direct flue

Ti offriamo la libertà di installare il tuo caminetto dove preferisci. Ad esempio, puoi far passare lo scarico del tuo caminetto attraverso la parete. Lo scarico si collega direttamente al caminetto e esce all'esterno con una curva di 90 gradi.

## scegli l'aspetto che preferisci

### Interni

Nero o ceraglass; quale si addice meglio ai tuoi interni?



### Finestra di vetro

Scegli il nostro vetro Clear View esclusivo: un vetro antiriflesso che ti garantisce una vista ottimale sulla fiamma.

### Vassoio del bruciatore

Infine scegli un vassoio del bruciatore adatto. Nella collezione Metro puoi scegliere fra i seguenti colori: set legna marrone, set legna bianco, pietre grigie, pietre bianche, vetro antracite.



Set di legna marrone



Set legna bianco



Pietre grigie



Pietre bianche



Vetro antracite



### Cornici

I nostri caminetti sono dotati di serie di una cornice, ma sono disponibili anche senza cornice o con delle cornici personalizzate.



### VBS

Tutti i caminetti a gas DRU sono dotati del sistema VBS. Questo sistema permette di garantire che il tuo caminetto continui a funzionare nonostante la composizione dei differenti tipi di gas. Non hai un allacciamento del gas fisso con gas naturale? Nessun problema. I nostri caminetti funzionano anche con butano, biogas o bio-propano.

## sostenibilità



### Eco Wave

Riduci i tuoi consumi di gas fino al 50% senza compromettere l'atmosfera nella tua casa.



## Metro 100XTU *Eco Wave*

### Proprietà:

- Interni interamente personalizzabili
- Installabile anche galleggiante o a mezza altezza

### Gamma di potenza

Gas naturale G20 **4,3 - 9,6 kW**

Gas naturale G25.3 **3,3 - 9,0 kW**

GPL G31 **4,1 - 9,1 kW**

### Grado di efficienza

83,3 %

**B**

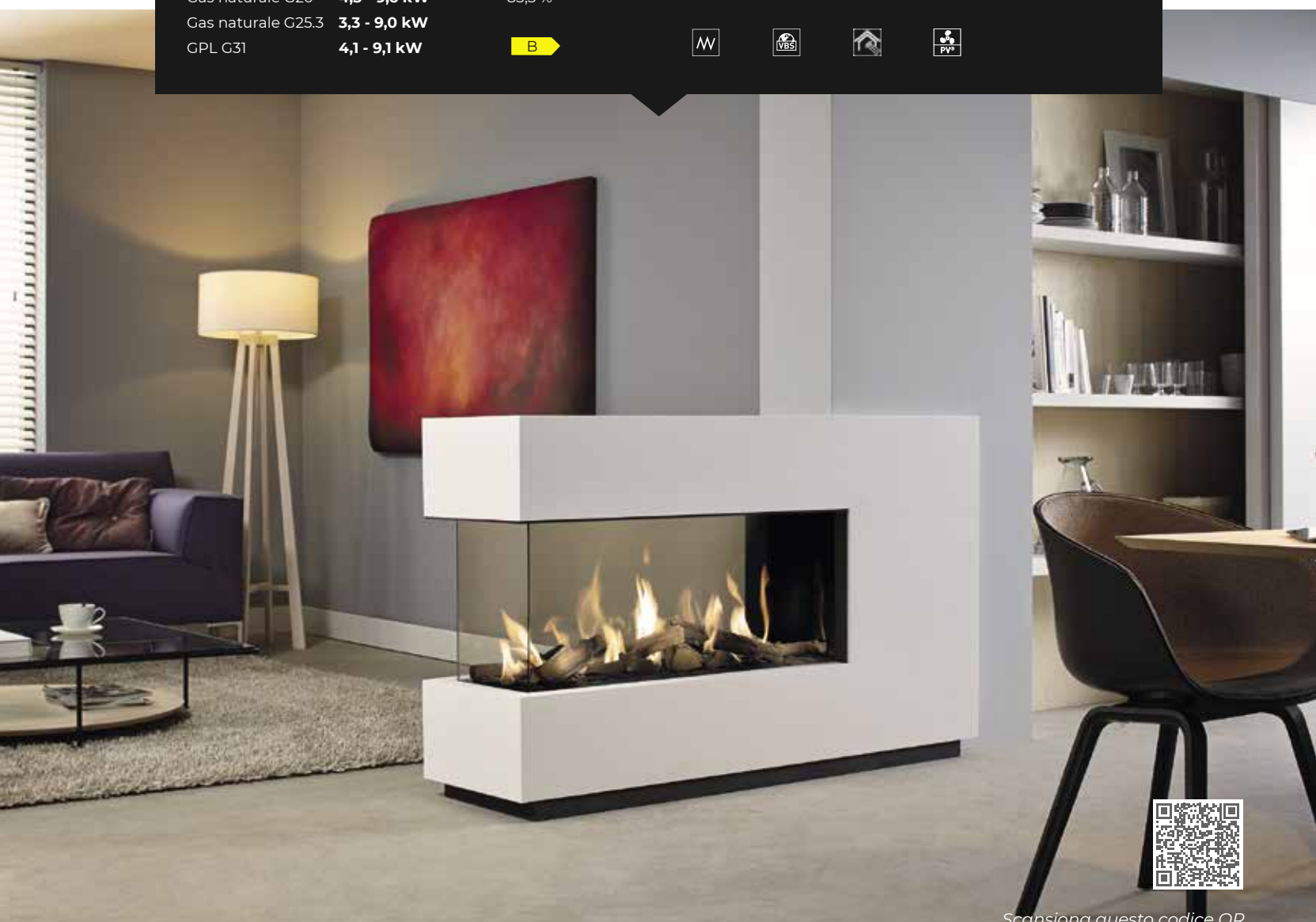

Scansiona questo codice QR  
per vedere un caminetto acceso.



Scansiona questo codice QR per vedere un caminetto acceso.



Metro 130XTL Eco Wave



## Metro 100XTL - 130XTL Eco Wave

### Proprietà:

- Crea l'atmosfera in più stanze
- Particolarmente adatto per un'installazione ad angolo

### Scegli il tuo formato:

(per le dimensioni esatte vedere a pag. 91)

100XTL

130XTL

### Gamma di potenza 100XTL

Gas naturale G20 4,3 - 9,6 kW

Gas naturale G25.3 3,3 - 9,0 kW

GPL G31 4,1 - 9,1 kW

### Gamma di potenza 130XTL

5,1 - 10,8 kW

4,1 - 10,2 kW

5,6 - 10,6 kW



### Grado di efficienza 100XTL

83,3 % **B**

### Grado di efficienza 130XTL

89,6 % **A**



## Metro 100XT/3 Eco Wave

### Proprietà:

- Fiamme ampie e piene d'atmosfera da qualsiasi angolo
- Particolarmente adatto per l'installazione in un mobile completo

### Scegli il tuo formato:

(per le dimensioni corrette vedere a pag. 92)

100XT/3

130XT/3

### Gamma di potenza

Gas naturale G20 4,3 - 9,6 kW

Gas naturale G25.3 3,3 - 9,0 kW

GPL G31 4,1 - 9,1 kW

### Grado di efficienza

83,3 %

**B**



Scansiona questo codice QR  
per vedere un caminetto acceso.



Scansiona questo codice QR  
per vedere un caminetto acceso.



## Metro 130XT/3 Eco Wave

### Proprietà:

- Scegli i ceppi di legna o i set di pietre più belli
- Disponibile con vetro antiriflesso in opzionale

### Scegli il tuo formato:

(per le dimensioni corrette vedere a pag. 92)

100XT/3

130XT/3

### Gamma di potenza

Gas naturale G20 **5,1 - 10,8 kW**  
 Gas naturale G25.3 **4,1 - 10,2 kW**  
 GPL G31 **5,6 - 10,6 kW**

### Grado di efficienza

89,6 %

A





## Metro 100XT/2 Eco Wave

### Proprietà:

- Caminetto angolare pieno d'atmosfera
- Possibilità di scegliere fra vari vassoi del bruciatore

### Scegli il tuo formato:

(per le dimensioni corrette vedere a pag. 92)

100XT/2

130XT/2

### Gamma di potenza

Gas naturale G20 **4,3 - 9,6 kW**

Gas naturale G25.3 **3,3 - 9,0 kW**

GPL G31 **4,1 - 9,1 kW**

### Grado di efficienza

83,3 %

**B**



Scansiona questo codice QR  
per vedere un caminetto acceso.





## Metro 130XT/2 Eco Wave

### Proprietà:

- Perfetto da integrare in una parete multimediale
- Incassabile anche senza telaio

### Scegli il tuo formato:

(per le dimensioni corrette vedere a pag. 92)

100XT/2

130XT/2

### Gamma di potenza

Gas naturale G20 **5,1 - 10,8 kW**

Gas naturale G25.3 **4,1 - 10,2 kW**

GPL G31 **5,6 - 10,6 kW**

### Grado di efficienza

89,6 %

**A**



Scansiona questo codice QR  
per vedere un caminetto acceso.



## Metro 80XT *Eco Wave*

### Proprietà:

- Ampia vista sulle fiamme
- Perfetto per le stanze più piccole

### Scegli il tuo formato:

(per le dimensioni corrette vedere a pag. 92)

80XT

100XT

130XT

150XT

200XT

### Gamma di potenza

Gas naturale G20 **3,0 - 5,4 kW**

Gas naturale G25.3 **2,3 - 5,1 kW**

GPL G31 **2,8 - 5,7 kW**

### Grado di efficienza

88,9 %

A





Scansiona questo codice QR  
per vedere un caminetto acceso.



DESIGN



Scansiona questo codice QR  
per vedere un caminetto acceso.



## Metro 100XT Eco Wave

### Proprietà:

- Scegli la modernità: vassoio del bruciatore in vetro antracite
- Fiamma a zigzag sull'intera larghezza e profondità

### Scegli il tuo formato:

(per le dimensioni corrette vedere a pag. 92)

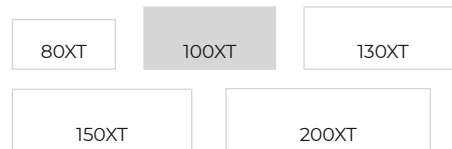

### Gamma di potenza

Gas naturale G20 **4,3 - 9,6 kW**  
 Gas naturale G25.3 **3,3 - 9,0 kW**  
 GPL G31 **4,1 - 9,1 kW**

### Grado di efficienza

83,3 %

**B**





## Metro 130XT - 150XT *Eco Wave*

### Proprietà:

- Fiamme sull'intera larghezza e profondità
- Interni interamente personalizzabili

### Scegli il tuo formato:

(per le dimensioni corrette vedere a pag. 92 + 93)

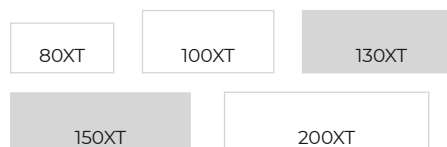

#### Gamma di potenza 130XT

Gas naturale G20 **5,1 - 10,8 kW**

Gas naturale G25.3 **4,1 - 10,2 kW**

GPL G31 **5,6 - 10,6 kW**

#### Grado di efficienza 130XT

89,6 % **A**

#### Gamma di potenza 150XT

**5,9 - 10,8 kW**

**4,9 - 10,3 kW**

**5,3 - 11,1 kW**

#### Grado di efficienza 150XT

87,9 % **A**



Scansiona questo codice QR  
per vedere un caminetto acceso.



Metro 130XT *Eco Wave*



Scansiona questo codice QR per vedere un caminetto acceso.



## Metro 200XT *Eco Wave*

### Proprietà:

- Il più grande nella sua specie
- Il set di legna non si distingue dai veri ceppi di legna

### Scegli il tuo formato:

(per le dimensioni corrette vedere a pag. 93)

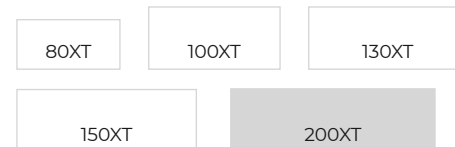

### Gamma di potenza

Gas naturale G20 **8,9 - 16,7 kW**  
 Gas naturale G25.3 **7,2 - 15,8 kW**  
 GPL G31 **7,3 - 15,4 kW**

### Grado di efficienza

90,3 %

**A**





## Metro 80XT Tunnel *Eco Wave*

### Proprietà:

- Divisorio in larghezza
- Bella fiamma visibile all'altezza giusta

### Scegli il tuo formato:

(per le dimensioni corrette vedere a pag. 93)

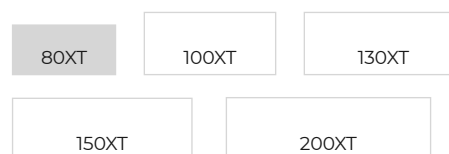

### Gamma di potenza

Gas naturale G20 3,0 - 5,4 kW

Gas naturale G25.3 2,3 - 5,1 kW

GPL G31 2,8 - 5,7 kW

### Grado di efficienza

88,9 %

A

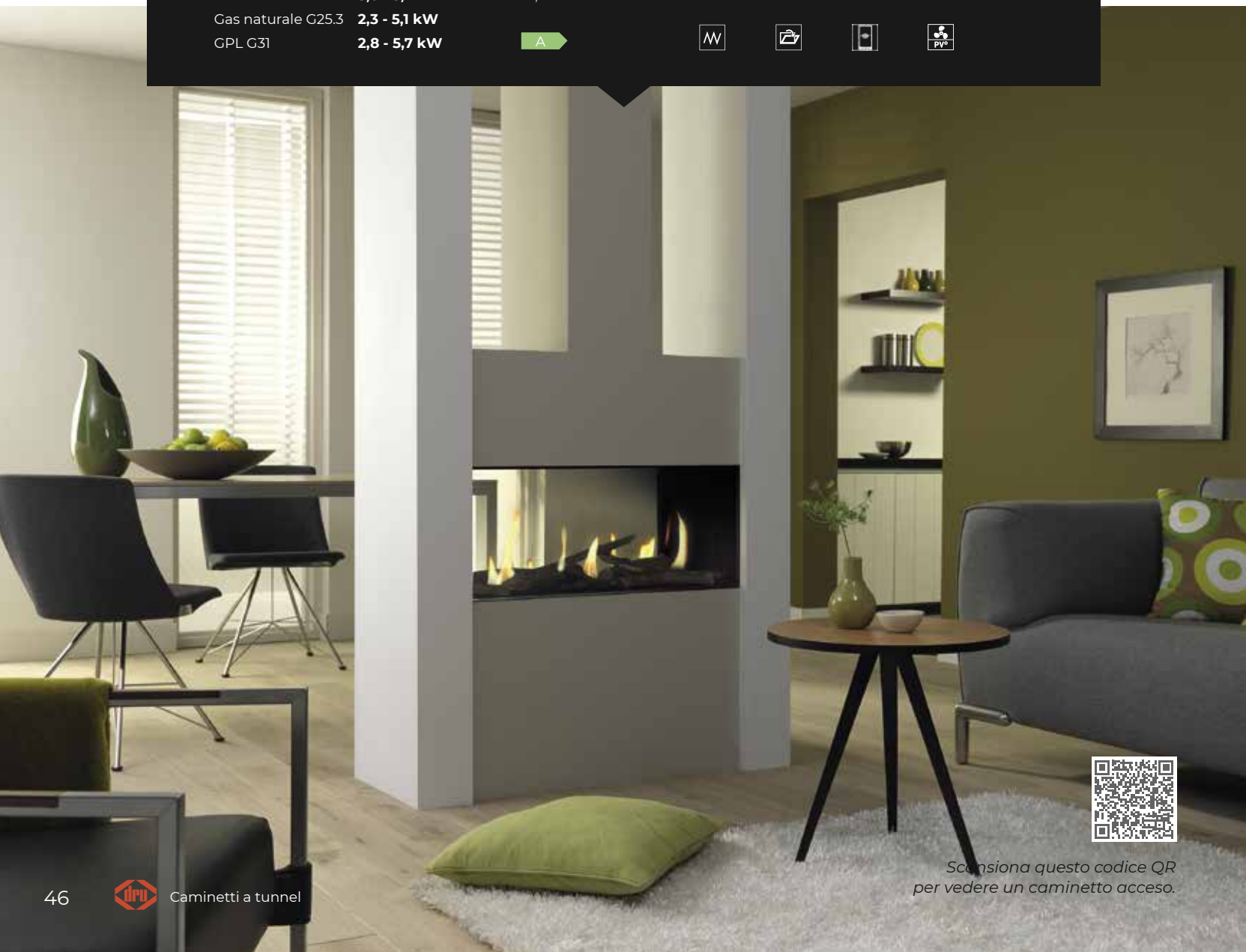

Scansiona questo codice QR  
per vedere un caminetto acceso.



Scansiona questo codice QR per vedere un caminetto acceso.



## Metro 100XT Tunnel *Eco Wave*

### Proprietà:

- Scegli un bel set di legna o delle pietre bianche
- Goditi il fuoco su due lati

### Scegli il tuo formato:

(per le dimensioni corrette vedere a pag. 93)

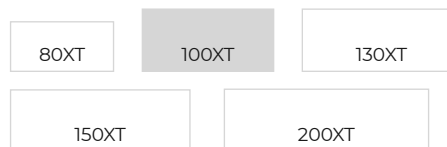

<b>Gamma di potenza</b>	<b>Grado di efficienza</b>				
Gas naturale G20 <b>4,3 - 9,6 kW</b>	83,3 %				
Gas naturale G25.3 <b>3,3 - 9,0 kW</b>					
GPL G31 <b>4,1 - 9,1 kW</b>	<b>B</b>				



## Metro 130XT Tunnel *Eco Wave*

### Proprietà:

- Imponente fuoco sull'intera larghezza
- Divisorio trasparente e pieno d'atmosfera

### Scegli il tuo formato:

(per le dimensioni corrette vedere a pag. 92)

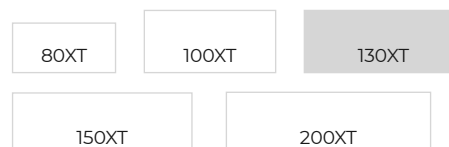

### Gamma di potenza

Gas naturale G20	5,1 - 10,8 kW
Gas naturale G25.3	4,1 - 10,2 kW
GPL G31	5,6 - 10,6 kW

### Grado di efficienza

89,6 %

A

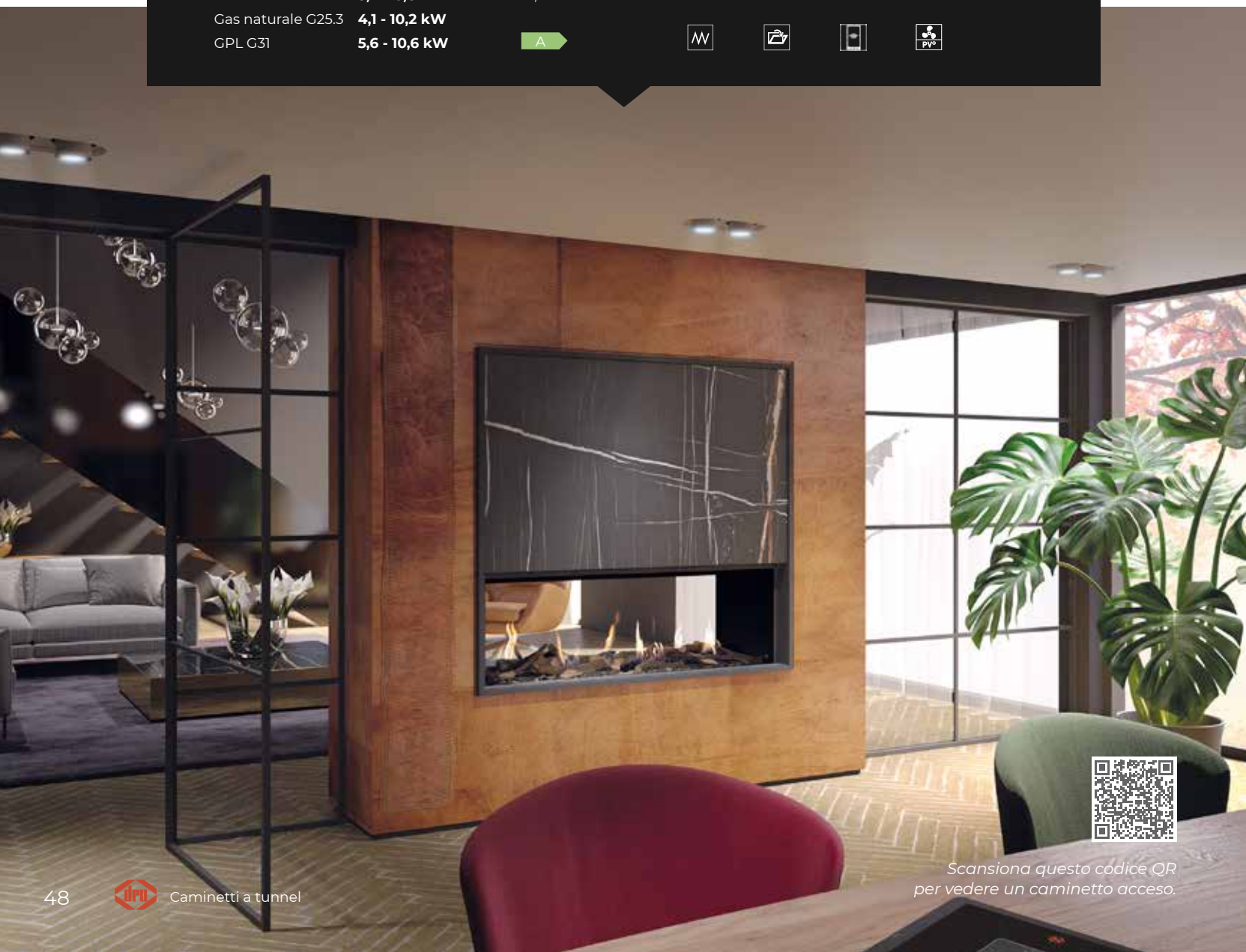

Scansiona questo codice QR  
per vedere un caminetto acceso.





Scansiona questo codice QR per vedere un caminetto acceso.



Metro 150XT Tunnel Eco Wave



## Metro 150XT - 200XT Tunnel Eco Wave

### Proprietà:

- Grande caminetto a tunnel
- Potenza termica personalizzata

### Scegli il tuo formato:

(per le dimensioni corrette vedere a pag. 93)

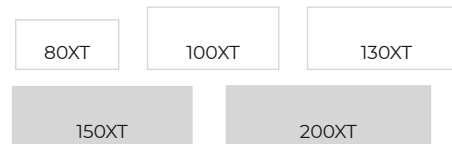

<p><b>Gamma di potenza 150XT Tunnel</b></p> <p>Gas naturale G20    <b>5,9 - 10,8 kW</b></p> <p>Gas naturale G25.3    <b>4,9 - 10,3 kW</b></p> <p>GPL G31    <b>5,3 - 11,1 kW</b></p>	<p><b>Gamma di potenza 200XT Tunnel</b></p> <p><b>8,9 - 16,7 kW</b></p> <p><b>7,2 - 15,8 kW</b></p> <p><b>7,3 - 15,4 kW</b></p>	
<p><b>Grado di efficienza 150XT Tunnel</b></p> <p>87,9 %    <b>A</b></p>	<p><b>Grado di efficienza 200XT Tunnel</b></p> <p>90,3 %    <b>A</b></p>	<p> nicci solo per il Metro 200XT</p>

# *i am* lugo

La sensazione di avere un vero caminetto a legna... chi non la vorrebbe!  
on i miei ceppi di legna impilati hai la sensazione di essere all'aperto, ma sei  
in casa al caldo. Poiché non ho aperture di ventilazione, ho sempre un design  
molto elegante. Tu puoi completare il mio design scegliendo una versione con  
il vetro su 2 o 3 lati.



### **3 lati**

*70/3 Eco Wave*

*80/3 Eco Wave*



### **2 lati**

*70/2 Eco Wave*

*80/2 Eco Wave*

## fiamma



### Vario Burner

Grazie alle fiamme alte e ampie a forma di zigzag, il fuoco riempie l'intero caminetto.

## comando

Comanda il tuo camino con estrema facilità grazie al **comando a distanza** fornito di serie



Utilizza la nostra pratica **app gratuita** per il controllo totale del tuo caminetto.



**Facile da accoppiare** al tuo sistema di Domotica



Nero

Ceraglass

## comodo da sapere



### PowerVent®

PowerVent® è un sistema di scarico concentrico plug & play con ventilatore.

La flessibilità di questo sistema di scarico consente di installare un caminetto a gas in quasi tutte le situazioni abitative.



### Cornici

I nostri caminetti sono dotati di serie di una cornice, ma sono disponibili anche senza cornice o con delle cornici personalizzate.



### VBS

Tutti i caminetti a gas DRU sono dotati del sistema VBS. Questo sistema permette di garantire che tutti i camini continuino a funzionare nonostante le diverse composizioni dei differenti tipi di gas. Non hai un allacciamento del gas fisso con gas naturale? Nessun problema. I nostri caminetti funzionano anche con butano, biogas o bio-propano.

## scegli l'aspetto che preferisci

### Interni

Nero o ceraglass; quale si addice meglio ai tuoi interni?

### Vassoio del bruciatore

I caminetti Lugo includono un set di legna realistico di colore marrone.

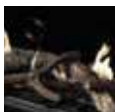

Set di legna marrone

## sostenibilità



### Eco Wave

Riduci i tuoi consumi di gas fino al 50% senza compromettere l'atmosfera nella tua casa.



## Lugo 70/3 - 80/3 Eco Wave

### Proprietà:

- Semplici giochi di fiamma
- Perfetto per le stanze più piccole

### Scegli il tuo formato:

(per le dimensioni corrette vedere a pag. 93)

70/3

80/3

### Gamma di potenza 70/3

Gas naturale G20 3,4 - 6,9 kW

Gas naturale G25.3 2,8 - 6,5 kW

GPL G31 3,2 - 6,3 kW

### Grado di efficienza 70/3

91,0 % **A**

### Gamma di potenza 80/3

3,4 - 6,9 kW

2,8 - 6,5 kW

3,2 - 6,3 kW

### Grado di efficienza 80/3

91,0 % **A**



Scansiona questo codice QR  
per vedere un caminetto acceso.

Lugo 80/3 Eco Wave



Scansiona questo codice QR per vedere un caminetto acceso.



Lugo 70/2 Eco Wave



## Lugo 70/2 - 80/2 Eco Wave

### Proprietà:

- Bella vista doppia sulle fiamme e molti ceppi di legna
- Profondità d'incasso limitata

### Scegli il tuo formato:

(per le dimensioni corrette vedere a pag. 93)

#### Gamma di potenza 70/2

Gas naturale G20 3,4 - 6,9 kW

Gas naturale G25,3 2,8 - 6,5 kW

GPL G31 3,2 - 6,3 kW

#### Grado di efficienza 70/2

91,0 % A

#### Gamma di potenza 80/2

3,4 - 6,9 kW

2,8 - 6,5 kW

3,2 - 6,3 kW

#### Grado di efficienza 80/2

91,0 % A



# *i am* **COSMO**

Preferisci qualcosa di grande? Allora sono il caminetto a gas che fa per te! Io sono infatti il caminetto decorativo a gas più grande e quindi il migliore creatore d'atmosfera per le stanze grandi. Nonostante il mio formato, posso essere incassato con eleganza oppure abbinato a una cappa.



## **Frontale**

*Cosmo Eco Wave*



## **Tunnel**

*Cosmo Tunnel Eco Wave*

## fiamma



### Vario Burner

Grazie alle fiamme alte e ampie a forma di zigzag, il fuoco riempie l'intero caminetto.

## comando

Comanda il tuo camino con estrema facilità grazie al **comando a distanza** fornito di serie



Utilizza la nostra pratica **app gratuita** per il controllo totale del tuo caminetto.



**Facile da accoppiare** al tuo sistema di Domotica



Nero

## comodo da sapere



### Easy release door system

Con l'Easy release door system non deve fare alcuno sforzo per aprire il tuo caminetto. Inoltre questa comoda porta a ribalta è l'ideale per la pulizia del tuo caminetto.



### PowerVent®

PowerVent® è un sistema di scarico concentrico plug & play con ventilatore. La flessibilità di questo sistema di scarico consente di installare un caminetto a gas in quasi tutte le situazioni abitative.



### VBS

Tutti i caminetti a gas DRU funzionano con differenti tipi di gas. Non hai un allacciamento del gas fisso con gas naturale? Nessun problema. I nostri caminetti funzionano anche con butano, biogas o bio-propano.

## scegli l'aspetto che preferisci

### Interni

Il caminetto Cosmo viene fornito di serie con un rivestimento interno di colore nero.



### Finestra di vetro

Scegli il nostro vetro Clear View esclusivo: un vetro antiriflesso che ti garantisce una vista ottimale sulla fiamma.

### Cappa

Il Cosmo è disponibile anche con una bella cappa 'Murano' con una struttura in acciaio inox e una base in pietra calcarea.

### Vassoio del bruciatore

I caminetti Cosmo includono un set di legna realistico di colore marrone.

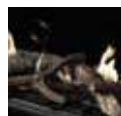

Set di legna marrone

## sostenibilità



### Eco Wave

Riduci i tuoi consumi di gas fino al 50% senza compromettere l'atmosfera nella tua casa.



## Cosmo Eco Wave

### Proprietà:

- Grazie all'ampia gamma di potenza è particolarmente adatto per l'uso nel settore alberghiero
- Disponibile con la bella cappa 'Murano' in opzionale

### Gamma di potenza

Gas naturale G20 **6,0 - 16,3 kW**

Gas naturale G25.3 **4,9 - 15,7 kW**

### Grado di efficienza

89,3 %

A

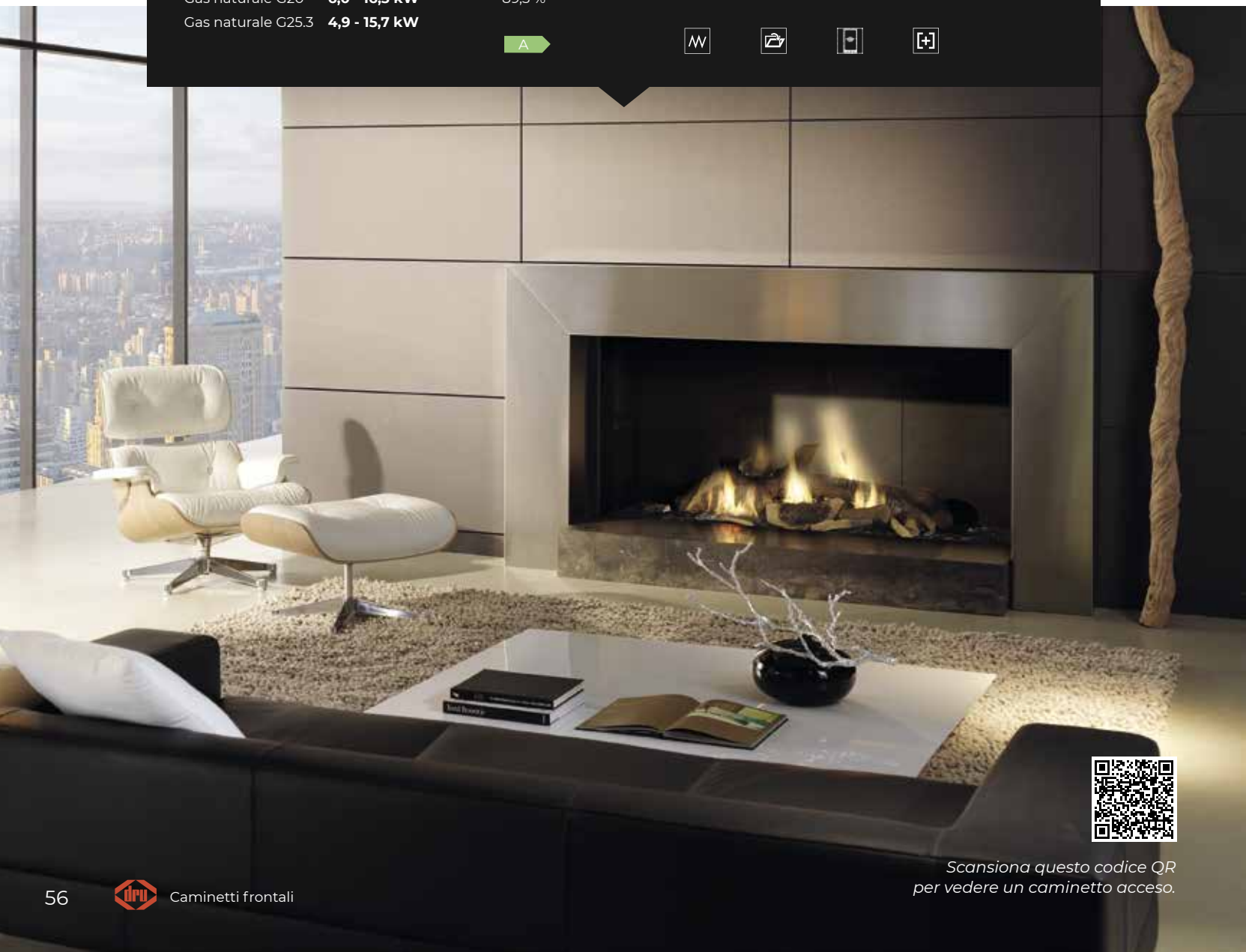

Scansiona questo codice QR  
per vedere un caminetto acceso.





Scansiona questo codice QR per vedere un caminetto acceso.



## Cosmo Tunnel Eco Wave

**Proprietà:**

- Non passa inosservato nelle grandi stanze
- Bellissimo set di legna robusto

<p><b>Gamma di potenza</b></p> <p>Gas naturale G20 <b>6,0 - 16,3 kW</b></p> <p>Gas naturale G25.3 <b>4,9 - 15,7 kW</b></p>	<p><b>Grado di efficienza</b></p> <p>89,3 %</p> <p><b>A</b> →</p>	<p>ECO</p> <p>VBS</p> <p>PVE</p>	<p>W</p> <p>+</p>
--	---	----------------------------------	-------------------

# *i am* **paco**

Il mio design compatto sta meglio in un angolo.

Ma ovviamente puoi anche montarmi contro una parete piatta.

Preferisci installarmi fuori dalla controparete? Nessun problema.

Per questo ho un set esterno speciale. Qualsiasi posizione tu scelga,  
io garantirò sempre un bell'effetto luminoso da ogni angolazione.



**2 lati**

*Paco Eco Wave*

## fiamma



### Line Burner

Un gioco di fiamma elegante sull'intera larghezza del caminetto.

## comando

Comanda il tuo camino con estrema facilità grazie al **comando a distanza** fornito di serie.



Utilizza la nostra pratica **app gratuita** per il controllo totale del tuo caminetto.



**Facile da accoppiare** al tuo sistema di Domotica



Ceraglass

## comodo da sapere



### PowerVent®

PowerVent® è un sistema di scarico concentrico plug & play con ventilatore. La flessibilità di questo sistema di scarico consente di installare un caminetto a gas in quasi tutte le situazioni abitative.



### VBS

Tutti i caminetti a gas DRU sono dotati del sistema VBS. Questo sistema permette di garantire che tutti i camini continuino a funzionare nonostante le diverse composizioni dei differenti tipi di gas. Non hai un allacciamento del gas fisso con gas naturale? Nessun problema. I nostri caminetti funzionano anche con butano, biogas o bio-propano.

## scegli l'aspetto che preferisci

Il modello Paco è un bel caminetto di base, ma con un dettaglio particolare: le fiamme vengono accese con un bell'effetto di luminosità.

### Vassoio del bruciatore

I caminetti Paco includono tutti un set di legna realistico marrone.

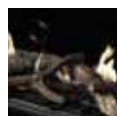

Set di legna marrone

## sostenibilità



### Eco Wave

Riduci i tuoi consumi di gas fino al 50% senza compromettere l'atmosfera nella tua casa.



## Paco Eco Wave



Set di legna Paco

### Proprietà

- Caminetto versatile per l'uso in un angolo
  - o contro una parete piatta
- Formato compatto con bassa potenza

### Gamma di potenza

Gas naturale G20 **2,6 - 5,4 kW**

Gas naturale G25.3 **2,1 - 5,0 kW**

### Grado di efficienza

84,8 %

**B**





*Scansiona questo codice QR  
per vedere un caminetto acceso.*

# *i am* indipendente

Flessibile è il mio secondo nome. Il mio colore interno ed esterno, ad esempio,

lo decidi tu. Oppure preferisci installarmi

sospeso o al centro del tuo soggiorno... io mi adatto a qualsiasi stanza.

Anche se è proprio quella che vuoi risparmiare.



## **3 lati**

Diablo Next

Circo

Maestro 60/3 Module *Eco Wave*

Passo *Eco Wave*

Polo

Trio

## fiamma



### Line Burner

Un gioco di fiamma elegante sull'intera larghezza del caminetto.



### Dynamic Flame Burner®

Fiamme vive e naturali costruite come un vero fuoco a legna. I doppi bruciatori garantiscono una fiamma molto alta e profonda.



## comando

Comanda il tuo camino con estrema facilità grazie al **comando a distanza** fornito di serie



Utilizza la nostra pratica **app gratuita** per il controllo totale del tuo caminetto.



**Facile da accoppiare** al tuo sistema di Domotica



Nero

Ceraglass

## comodo da sapere



### Easy release door system

Con l'Easy release door system non devi fare alcuno sforzo per aprire il tuo caminetto. Inoltre questa comoda porta a ribalta è l'ideale per la pulizia del tuo caminetto.



### VBS

Tutti i caminetti a gas DRU sono dotati del sistema VBS. Questo sistema permette di garantire che il tuo caminetto continui a funzionare nonostante la composizione dei differenti tipi di gas. Non hai un allacciamento del gas fisso con gas naturale? Nessun problema. I nostri caminetti funzionano anche con butano, biogas o bio-propano.

## scegli l'aspetto che preferisci

### Interni

Nero o ceraglass; quale si addice meglio ai tuoi interni?



### Finestra di vetro

Scegli il nostro vetro Clear View esclusivo: un vetro antiriflesso che ti garantisce una vista ottimale sulla fiamma.

### Vassoio del bruciatore

I caminetti indipendenti includono un set di legna realistico di colore marrone.

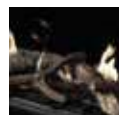

Set di legna marrone

## sostenibilità



### Eco Wave

Riduci i tuoi consumi di gas fino al 50% senza compromettere l'atmosfera nella tua casa.



### Eco Glow

Preferisci non avere calore, ma non vuoi rinunciare all'atmosfera? Allora passa al letto incandescente illuminato.



## Maestro 60/3 Module *Eco Wave*

### Proprietà

- Caminetto a gas di lusso con l'aspetto di un vero caminetto a legna
- Disponibile in alluminio bianco o grigio struttura

### Rivestimento in alluminio:

- Bianco o grigio



### Gamma di potenza

Gas naturale G20	<b>1,9 - 7,2 kW</b>
Gas naturale G25.3	<b>1,6 - 6,8 kW</b>
GPL G31	<b>1,1 - 7,3 kW</b>

### Grado di efficienza

94,3 %

**A**







Scansiona questo codice QR  
per vedere un caminetto acceso.





## Passo *Eco Wave*

### Proprietà:

- Vista a 180 gradi su delle belle fiamme alte
- Disponibile in 6 colori



Nero



Titan



Perla



Bianco



Grigio chiaro



Turchese

### Gamma di potenza

Gas naturale G20 **1,2 - 6,4 kW**

Gas naturale G25.3 **0,9 - 6,1 kW**

### Grado di efficienza

93,0 %

A





*Scansiona questo codice QR  
per vedere un caminetto acceso.*





## Polo

### Proprietà:

- Pieno d'atmosfera in piccole stanze
- Consumi molto bassi

### Gamma di potenza

Gas naturale G20 1,6 - 4,1 kW

Gas naturale G25.3 1,5 - 3,8 kW

GPL G31 1,6 - 3,8 kW

### Grado di efficienza

92,6 %

A



Scansiona questo codice QR  
per vedere un caminetto acceso.

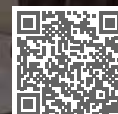

Scansiona questo codice QR  
per vedere un caminetto acceso.



## Diablo Next

### Proprietà:

- Si adatta ovunque, senza perdere spazio sul pavimento
- Scegli una finitura nera o alluminio

### Gamma di potenza

Gas naturale G20 **1,6 - 4,1 kW**  
Gas naturale G25.3 **1,5 - 3,8 kW**  
GPL G31 **1,6 - 3,8 kW**

### Grado di efficienza

92,6 %



A



## Circo

### Proprietà:

- Caminetto decorativo robusto per ogni stanza
- Il vetro rotondo offre un'ampia vista sulla fiamma

#### Gamma di potenza

Gas naturale G20 **2,9 - 7,0 kW**

Gas naturale G25.3 **2,7 - 6,0 kW**

GPL G31 **2,8 - 6,2 kW**

#### Grado di efficienza

92,5 %

**A** →



Technical specifications and efficiency information for the Circo fireplace, presented in a dark overlay. The overlay includes a table of power ranges for different gas types and an efficiency rating of 92.5% with an 'A' energy class indicator. Navigation icons for minus, home, and verified status are also present.



Scansiona questo codice QR  
per vedere un caminetto acceso.



Scansiona questo codice QR  
per vedere un caminetto acceso.

Scansiona questo codice QR  
per vedere un caminetto acceso.



## Trio Black Edition

### Proprietà:

- Forme eleganti con un forte carisma
- Fiamma alta da 3 lati

### Gamma di potenza

Gas naturale G20 **2,0 - 4,5 kW**  
Gas naturale G25.3 **1,8 - 4,2 kW**  
GPL G31 **1,5 - 4,0 kW**

### Grado di efficienza

85,4 %



**B**



# *i am* global

Un piccolo soggiorno? Allora io vado benissimo. Infatti sono molto compatto  
e ho un prezzo davvero interessante. Mettimi dove vuoi, sia che si tratti di  
un'abitazione ben isolata o di un'abitazione con una canna fumaria esistente.  
Insomma: se vuoi qualcosa di accessibile, allora scegli Global!



### **3 lati**

60 Triple  
100 Triple  
120 Triple



### **2 lati**

60 Corner  
100 Corner  
120 Corner



### **Frontale**

55XT BF  
55XT BF Cavity  
70XT BF  
100 BF  
120 BF  
55XT CF  
70XT CF



## fiamma



### Line Burner

Un gioco di fiamma elegante sull'intera larghezza del caminetto.



### TruFlame Burner®

Fiamme molte alte in una configurazione con fuoco a legna naturale.



## comando

Comanda il tuo camino con estrema facilità grazie al **comando a distanza** fornito di serie



**Facile da accoppiare** al tuo sistema di Domotica



Nero

Ceraglass

Classico pietra (DRU Global)

## comodo da sapere



### Direct flue

Ti offriamo la libertà di installare il tuo caminetto dove preferisci. Ad esempio, puoi far passare lo scarico del tuo caminetto attraverso la parete. Lo scarico si collega direttamente al caminetto e esce all'esterno con una curva di 90 gradi.



### VBS

Tutti i caminetti a gas DRU sono dotati del sistema VBS. Questo sistema permette di garantire che il tuo caminetto continui a funzionare nonostante la composizione dei differenti tipi di gas. Non hai un allacciamento del gas fisso con gas naturale? Nessun problema. I nostri caminetti funzionano anche con butano, biogas o bio-propano.

## scegli l'aspetto che preferisci

### Interni

Con i nostri caminetti DRU Global puoi scegliere fra 3 tipi di rivestimento interno.



### Finestra di vetro

Scegli il nostro vetro esclusivo Clear View: un vetro antiriflesso che ti garantisce una vista ottimale sul fuoco.

### Vassoio del bruciatore

Infine scegli un vassoio del bruciatore adatto. Nella collezione DRU Global puoi scegliere fra i seguenti colori: set legna marrone, pietre bianche o vetro antracite



Set di legna marrone



Pietre bianche



Vetro antracite



## Global 60 Triple BF

### Proprietà:

- Vista del fuoco da 3 lati
- Profondità d'incasso molto ridotta

### Scegli il tuo formato:

(per le dimensioni corrette vedere a pag. 94)

60 Triple BF

100 Triple BF

120 Triple BF

### Gamma di potenza

Gas naturale G20 **2,3 - 6,0 kW**

Gas naturale G25.3 **2,1 - 5,4 kW**

GPL G31 **3,0 - 6,2 kW**

### Grado di efficienza

91,5 %

A



BF





Scansiona questo codice QR per vedere un caminetto acceso.



Global 100 Triple BF



## Global 100 Triple BF - 120 Triple BF

### Proprietà:

- Vista panoramica sul fuoco
- Scegli il tuo vassoio del bruciatore (legno/pietra/vetro)

### Scegli il tuo formato:

(per le dimensioni corrette vedere a pag. 94)

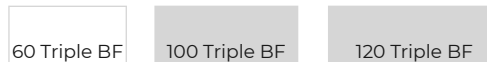

#### Gamma di potenza 100 Triple BF

Gas naturale G20 **2,8 - 7,5 kW**

Gas naturale G25.3 **2,6 - 7,1 kW**

GPL G31 **3,5 - 7,0 kW**

#### Grado di efficienza 100 Triple BF

94,0 % **A**

#### Gamma di potenza 120 Triple BF

Gas naturale G20 **2,8 - 7,5 kW**

Gas naturale G25.3 **2,6 - 7,1 kW**

GPL G31 **3,5 - 7,0 kW**

#### Grado di efficienza 120 Triple BF

94,0 % **A**





## Global 60 Corner BF

### Proprietà:

- Perfetto per le stanze più piccole
- Caminetto a gas a 2 lati

### Scegli il tuo formato:

(per le dimensioni corrette vedere a pag. 94)

60 Corner BF

100 Corner BF

120 Corner BF

### Gamma di potenza

Gas naturale G20 **2,3 - 6,0 kW**

Gas naturale G25.3 **2,1 - 5,4 kW**

GPL G31 **3,0 - 6,2 kW**

### Grado di efficienza

91,5 %

A



## Global 120 Corner BF





Scansiona questo codice QR per vedere un caminetto acceso.



Scansiona questo codice QR per vedere un caminetto acceso.



## Global 100 Corner BF - 120 Corner BF

### Proprietà:

- Ampia vista sulle fiamme grazie all'uso ridotto di cornici
- Grado di efficienza molto elevato

### Scegli il tuo formato:

(per le dimensioni corrette vedere a pag. 95)

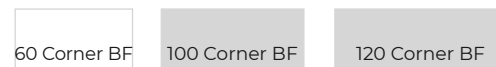

### Gamma di potenza 100 Corner BF

Gas naturale G20 **2,8 - 7,5 kW**  
 Gas naturale G25.3 **2,6 - 7,1 kW**  
 GPL G31 **3,5 - 7,0 kW**

### Grado di efficienza 100 Corner BF

94,0 % **A**

### Gamma di potenza 120 Corner BF

**2,8 - 7,5 kW**  
**2,6 - 7,1 kW**  
**3,5 - 7,0 kW**

### Grado di efficienza 120 Corner BF

94,0 % **A**





## Global 55XT Cavity BF

### Proprietà:

- Adatto per l'installazione in una cavità
- Include attacco per canna fumaria e canale di convezione



Sistema per cavità

### Gamma di potenza

Gas naturale G20 **1,8 - 3,2 kW**

### Grado di efficienza

77,4 %



Disponibile solo  
nel Regno Unito



Scansiona questo codice QR  
per vedere un caminetto acceso.



Scansiona questo codice QR  
per vedere un caminetto acceso.



## Global 55XT BF - 70XT BF







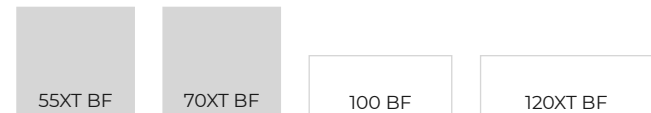

### Proprietà:

- Fiamme alte e compatte estremamente realistiche
- Profondità d'incasso ridotta

### Scegli il tuo formato:

(per le dimensioni corrette vedere a pag. 95)



Gamma di potenza 55XT BF		Gamma di potenza 70XT BF		  		
Gas naturale G20	2,6 - 4,6 kW	Gas naturale G20	3,4 - 5,7 kW	  		
Gas naturale G25.3	2,4 - 4,3 kW	Gas naturale G25.3	3,1 - 5,3 kW			
GPL G31	3,1 - 4,4 kW	GPL G31	3,2 - 5,5 kW			
Grado di efficienza 55XT BF		Grado di efficienza 70XT BF				
92,6 % 		92,7 % 				



## Global 100 BF - 120 BF

### Proprietà

- Ampia vista sulle belle fiamme
- Grado di efficienza molto elevato e rispettoso dell'ambiente

### Scegli il tuo formato:

(per le dimensioni corrette vedere a pag. 95)



### Gamma di potenza 100 BF

Gas naturale G20 **2,8 - 7,5 kW**  
Gas naturale G25.3 **2,6 - 7,1 kW**  
GPL G31 **3,5 - 7,0 kW**

### Grado di efficienza 100 BF

94,0 % **A**

### Gamma di potenza 120 BF

Gas naturale G20 **2,8 - 7,5 kW**  
Gas naturale G25.3 **2,6 - 7,1 kW**  
GPL G31 **3,5 - 7,0 kW**

### Grado di efficienza 120 BF

94,0 % **A**



Global 120 BF





Scansiona questo codice QR  
per vedere un caminetto acceso.





# Global 55XT CF

### Proprietà

- Ampia scelta d'interni
- Perfetto da allacciare a una canna fumaria esistente

### Scegli il tuo formato:

(per le dimensioni corrette vedere a pag. 95)



<b>Gamma di potenza</b>	<b>Grado di efficienza</b>			
Gas naturale G20 <b>2,8 - 3,7 kW</b>	74,4 %			
Gas naturale G25.3 <b>2,6 - 3,5 kW</b>				

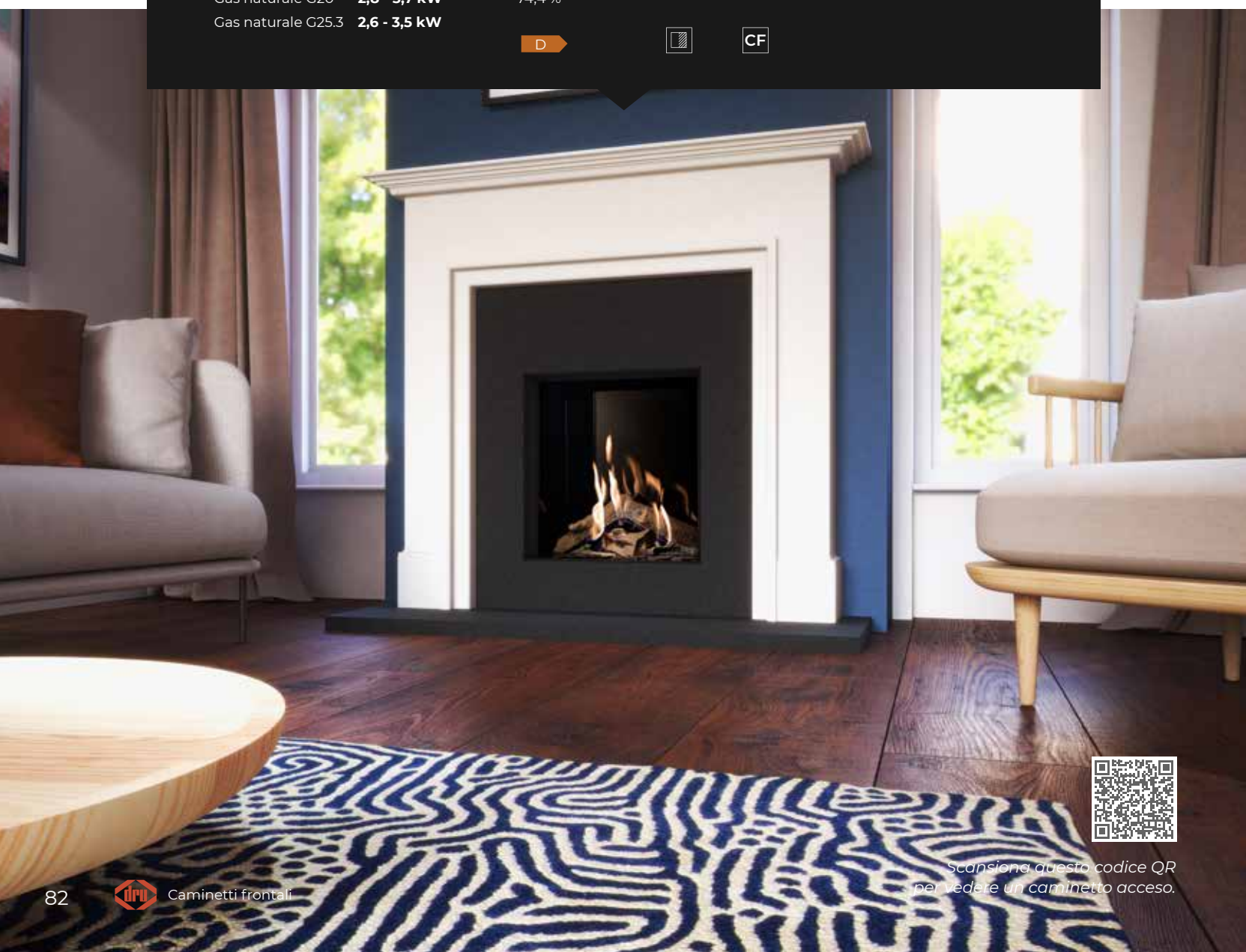

Scansiona questo codice QR per vedere un caminetto acceso.





Scansiona questo codice QR per vedere un caminetto acceso.



## Global 70XT CF

### Proprietà:

- Caminetto poco profondo che occupa poco spazio
- Perfetto per un incasso elegante in una canna fumaria esistente

### Scegli il tuo formato:

(per le dimensioni corrette vedere a pag. 95)



### Gamma di potenza

Gas naturale G20 **3,1 - 4,5 kW**  
 Gas naturale G25.3 **2,7 - 4,4 kW**  
 GPL G31 **4,0 - 4,6 kW**

### Grado di efficienza

77,1 %



# un caminetto a gas in ogni posto desiderato



PowerVent®

## Cos'è il PowerVent®?

Per un caminetto a gas ti serve ovviamente uno scarico. Una canna fumaria esistente, uno scarico attraverso il tetto o la parete, oppure il nostro PowerVent®. PowerVent® è un sistema di scarico concentrico plug & play con ventilatore. La flessibilità di questo sistema di scarico consente di installare un caminetto a gas in quasi tutte le situazioni abitative. Un appartamento, un'abitazione semi-terrazzata o un edificio senza canna fumaria? Nessun problema! PowerVent® ti offre la libertà di installare il tuo caminetto a gas dove vuoi.

## Vantaggi di DRU PowerVent®

- Possibilità di aver uno scarico fino a 100 metri con diverse curve
- Diametro del canale di 10 cm
- Unità di regolazione nel pannello di comando, con manometro incluso
- Powerbox compatto, installabile sia dentro che fuori
- La soluzione perfetta per abitazioni semi-terrazzate, appartamenti, ristoranti, hotel, negozi e fattorie

# non hai una canna fumaria ma vuoi comunque installare un caminetto a gas?



## Canna fumaria esistente

- Attraverso il tetto
- tubo flessibile nella canna fumaria

## Nessuna canna fumaria



- Attraverso il tetto (piatto)
- diretta o con curve



- Attraverso il tetto (inclinata)
- diretta o con curve



- Attraverso la parete / Direct flue
- direttamente sul caminetto con una curva di 90° verso l'esterno
- possibile per un'ampia parte dell'assortimento



- Attraverso la parete
- prima 1 metro verticale, quindi una curva da 90°

## PowerVent®

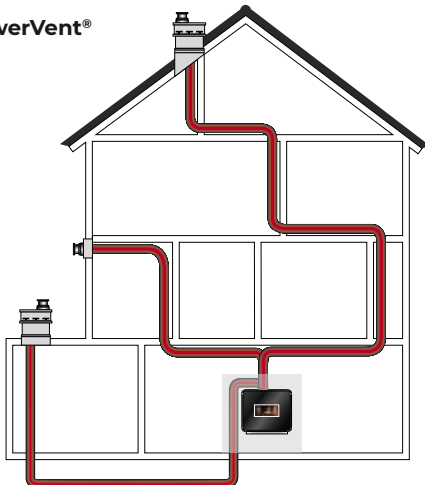

- Fino a 100 metri orizzontale
- Possibilità di molte curve
- Attraverso la cavità



Scansiona questo Codice QR

**finitura  
elegante  
e senza cornici**

# [+] cornici



Senza cornici, cornice inferiore rimossa



Cornice standard



Cornice in opzione  
(personalizzazione possibile)

## Con o senza cornici

Tutti i nostri caminetti a gas sono dotati di serie di una cornice. Preferisci integrare il tuo caminetto a gas senza problemi nel resto del tuo arredamento? Puoi farlo! Per alcuni caminetti infatti è possibile togliere la parte più inferiore della cornice. In questo modo il caminetto viene incassato con eleganza in una struttura di pietre naturali o ad esempio inserita nel pavimento, direttamente contro il vetro.

## Realizzalo completamente su misura

Vuoi personalizzare ulteriormente il tuo caminetto? Per i caminetti da incasso nella panoramica sottostante sei tu a decidere la larghezza della cornice. In questo modo il caminetto si integra veramente nel tuo arredamento.

Caminetti che possono essere incassati senza cornici			
Caminetti a 3 lati	Caminetti a 2 lati	Caminetti frontali	Caminetti a tunnel
Lugo 70/3	Lugo 70/2	Cosmo	Cosmo Tunnel
Lugo 80/3	Lugo 80/2	Maestro 60	Maestro 75 Tunnel
Maestro 60/3	Maestro 60/2	Maestro 60 Tall	Maestro 75 Tunnel Tall
Maestro 60/3 Tall	Maestro 60/2 Tall	Maestro 75	Metro 200XT Tunnel
Maestro 75XTU	Maestro 80/2	Maestro 100	
Maestro 80/3	Maestro 105/2	Metro 200XT	
Maestro 105/3	Metro 100XT/2		
Metro 100XT/3	Metro 130XT/2		
Metro 100XTL			
Metro 100XTU			
Metro 130XT/3			

Cornici in opzione			
Caminetti a 3 lati	Caminetti a 2 lati	Caminetti frontali	Caminetti a tunnel
Lugo 70/3 <sup>1</sup>	Lugo 70/2 <sup>1</sup>	Metro 200XT <sup>6</sup>	Metro 200XT Tunnel <sup>6</sup>
Lugo 80/3 <sup>1</sup>	Lugo 80/2 <sup>1</sup>	Maestro 60 <sup>4</sup>	Maestro 75 Tunnel <sup>5</sup>
Maestro 60/3 <sup>2</sup>	Maestro 60/2 <sup>2</sup>	Maestro 60 Tall <sup>4</sup>	Maestro 75 Tunnel Tall <sup>5</sup>
Maestro 60/3 Tall <sup>2</sup>	Maestro 60/2 Tall <sup>2</sup>	Maestro 75 <sup>5</sup>	
Maestro 75XTU <sup>2</sup>	Maestro 80/2 <sup>3</sup>	Maestro 75 Tall <sup>5</sup>	
Maestro 80/3 <sup>3</sup>	Maestro 105/2 <sup>3</sup>	Maestro 100 <sup>5</sup>	
Maestro 105/3 <sup>3</sup>	Metro 100XT/2 <sup>1</sup>		
Metro 100XT/3 <sup>1</sup>	Metro 130XT/2 <sup>1</sup>		
Metro 100XTL <sup>1</sup>			
Metro 100XTU <sup>1</sup>			
Metro 130XT/3 <sup>1</sup>			

<sup>1</sup> 100 mm, personalizzazione 90-200 mm

<sup>2</sup> 110 mm, personalizzazione 100-200 mm

<sup>3</sup> 110 mm, personalizzazione 90-200 mm

<sup>4</sup> 110 o 140 mm, personalizzazione 70-200 mm

<sup>5</sup> 100 o 130 mm, personalizzazione 70-200 mm

<sup>6</sup> 105 o 135 mm, personalizzazione 65-200 mm

# controllo totale e estrema praticità



### Telecomando RCH (DRU)

- ampie funzioni di comando
- Controllo Honeywell



### Telecomando RCE (DRU e DRU Global)

- comando semplice
- Controllo Mertik



### Domotica Home Automation

- Possibilità di collegamento ai vari sistemi di domotica
- Per controllo Honeywell e Mertik

Tutti i telecomandi sono dotati di accensione elettronica, termostato e funzione timer.



### App + modulo di comunicazione

Vuoi avere il controllo totale sulla tipologia di fiamma? Allora scegli il modulo di comunicazione Eco Wave. Con l'app di controllo DRU scaricabile gratuitamente su smartphone e tablet (IOS/Android) non si attiva solo il caminetto, ma si imposta anche la tipologia della fiamma. Questo modulo è adatto solo per i caminetti dotati del sistema Eco Wave.



### Modulo di gestione

DRU e ICY hanno sviluppato un modulo per la gestione locale dei caminetti e da un sistema di ricezione ideato appositamente per il settore ricreativo (parchi vacanza, hotel, ecc.).

- Con sensore di luce e movimento per sfruttare al meglio e consapevolmente l'energia
- Innovativo e di facile utilizzo
- Niente più pile e telecomandi



### Pannello di comando

In caso di manutenzione e guasti è importante avere sempre accesso al blocco di regolazione del gas. Per questo DRU ha progettato un pannello di comando speciale. Questo pannello di comando può essere integrato benissimo nella configurazione del caminetto.



# elementi di ventilazione

## Ventilazione della cappa per proteggere la struttura

Riscaldando il caminetto, il calore viene immagazzinato nella struttura. Il caminetto necessita di un ricircolo dell'aria per evitare il surriscaldamento. A tale scopo, DRU ha progettato numerosi elementi Lux nei colori bianco avorio, alluminio metallizzato e antracite. Questi saranno integrati nella struttura e possono essere dotati di un'illuminazione decorativa.

- ❶ Bianco avorio
- ❷ Alluminio metallizzato
- ❸ Antracite



Lux Fino ❶ ❸



Lux Sleeve ❶ ❷



Lux Lignum ❶



Lux Omni ❶ ❷



Lux ❶ ❷

**Maestro 75XTU** (P. 16)

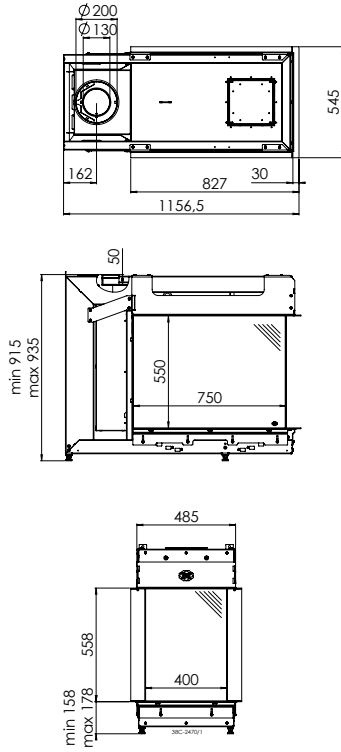

**Maestro 60/3** (P. 18)

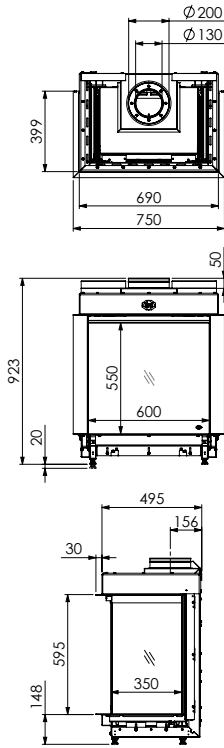

**Maestro 60/3 Tall** (P. 19)

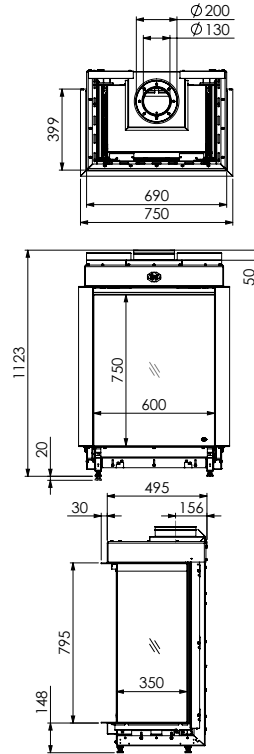

**Maestro 80/3** (P. 20)

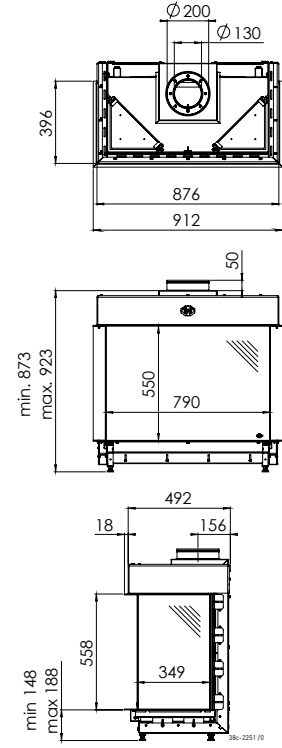

**Maestro 105/3** (P. 21)

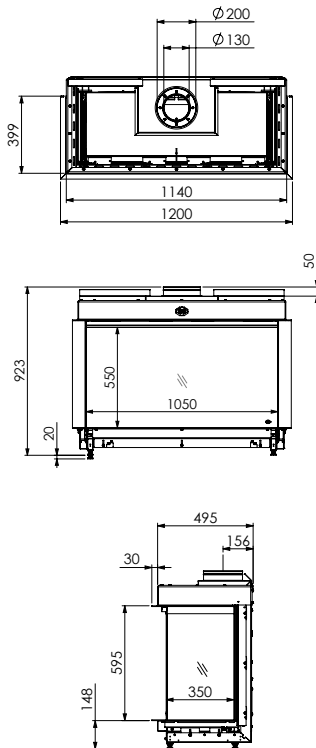

**Maestro 60/2** (P. 22)

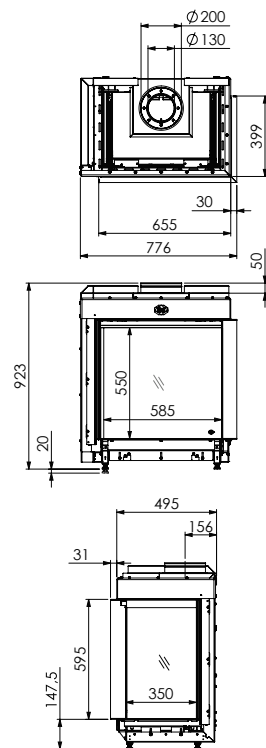

**Maestro 60/2 Tall** (P. 23)

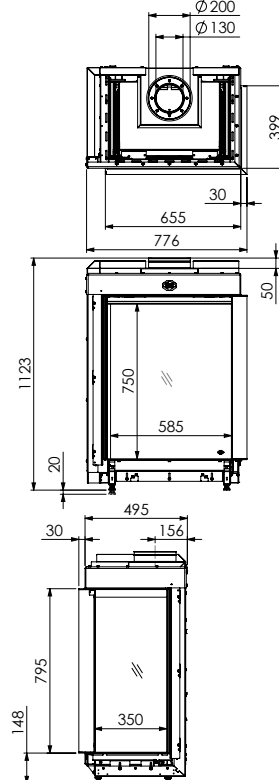

**Maestro 80/2** (P. 24)

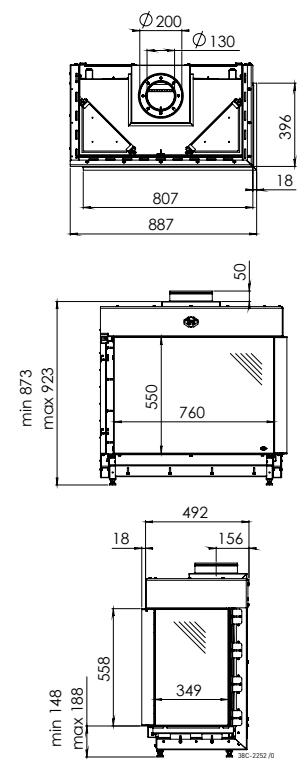

Maestro 105/2 (P. 25)

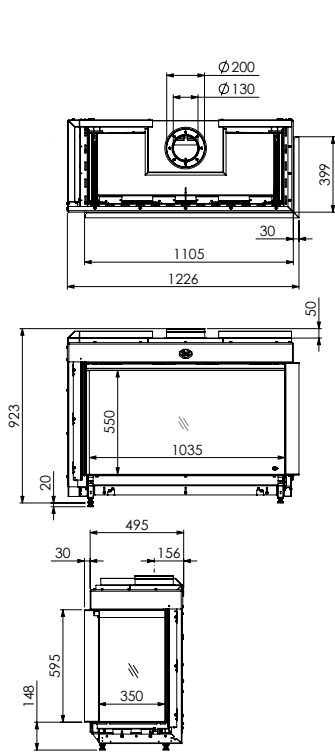

Maestro 60 (P. 26)

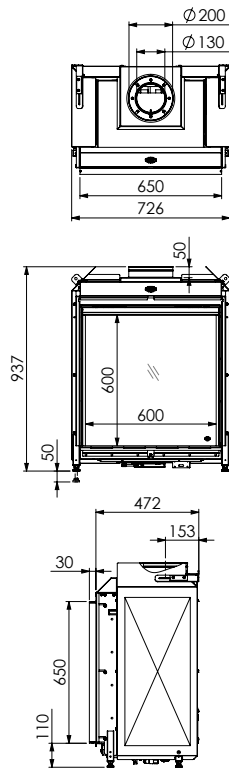

Maestro 60 Tall (P. 27)

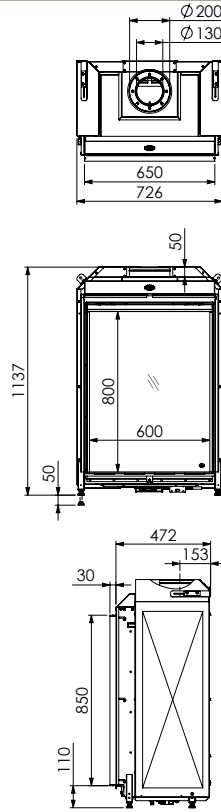

Maestro 75 | Tunnel (P. 28, 32)

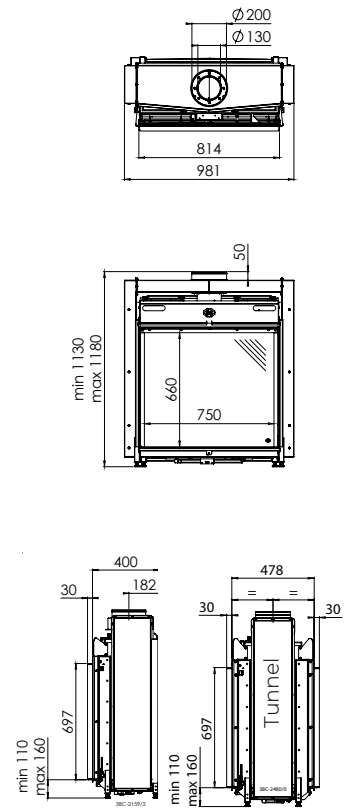

Maestro 75 Tall | Tunnel (P. 29, 33)

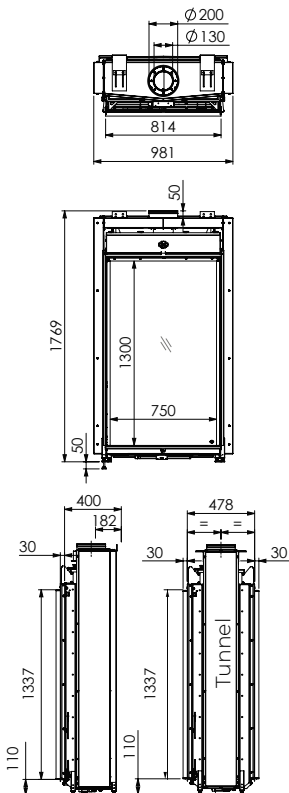

Maestro 100 (P. 30)

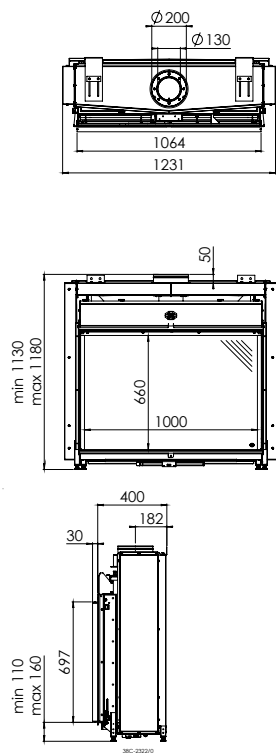

Metro 100XTU (P. 36)

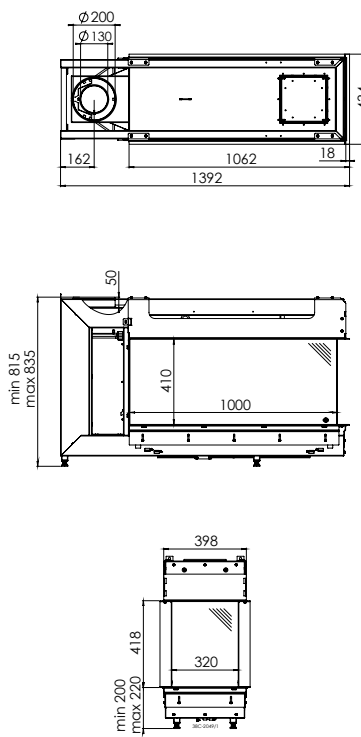

Metro 100XTL (P. 37)

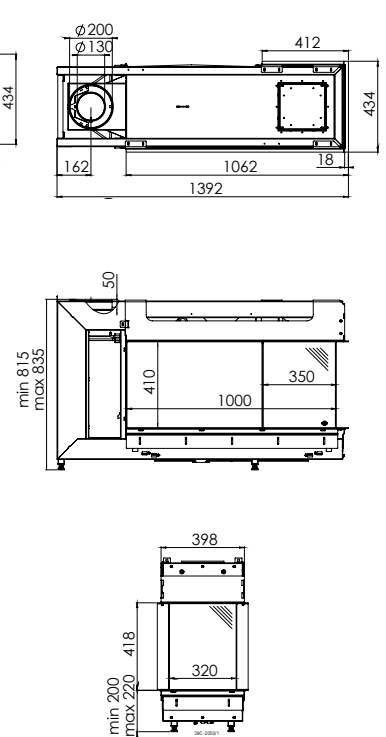

Metro 130XTL (P. 37)

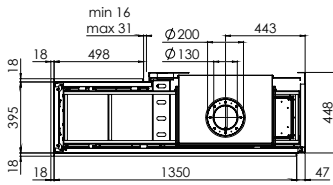

Metro 100XT/3 (P. 38)

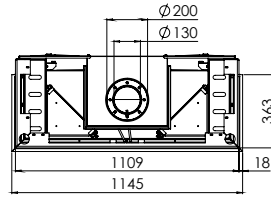

Metro 130XT/3 (P. 39)

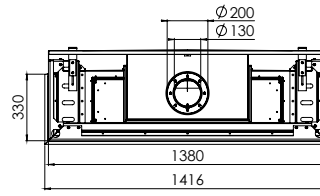

Metro 100XT/2 (P. 40)

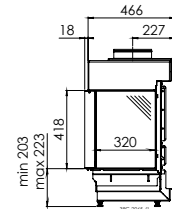
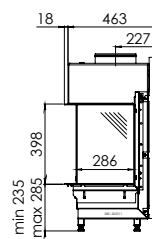
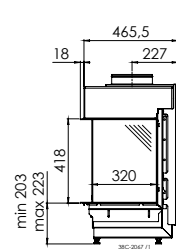
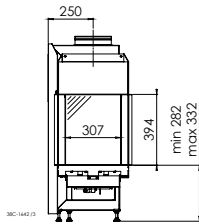
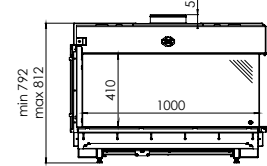
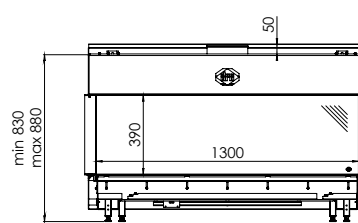
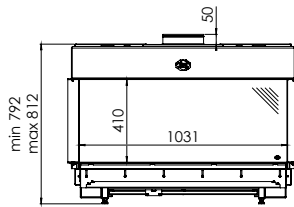
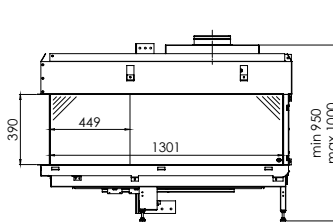
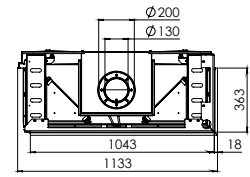

Metro 130XT/2 (P. 41)

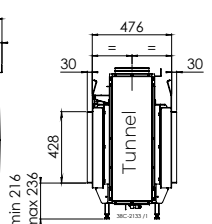
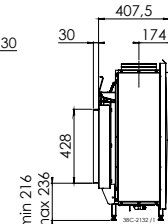
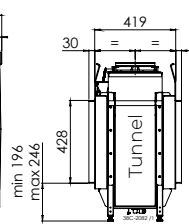
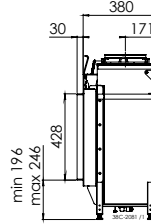
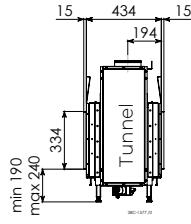
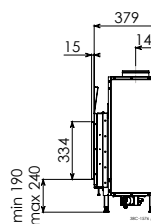
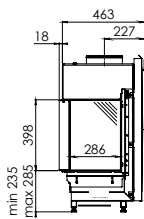
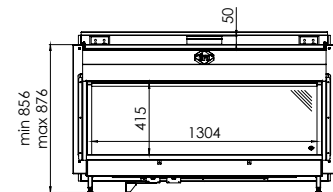
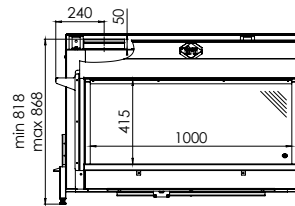
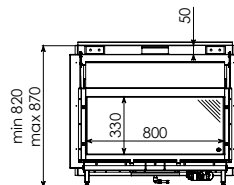
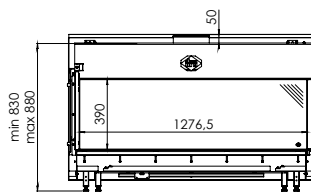
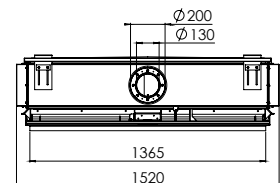
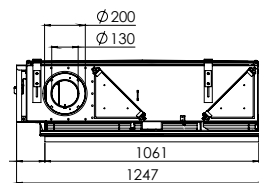
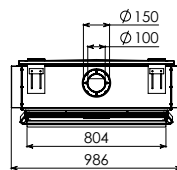
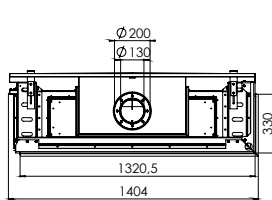

Metro 150XT | Tunnel (P. 44, 49)

Metro 200XT | Tunnel (P. 45, 49)

Lugo 70/3 (P. 52)

Lugo 80/3 (P. 52)

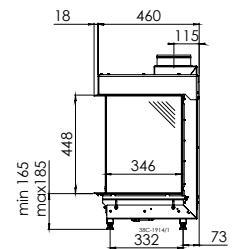
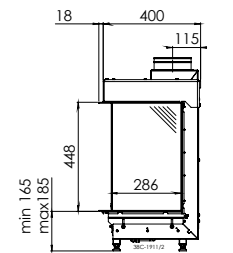
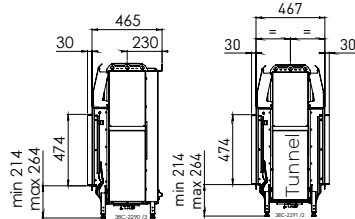
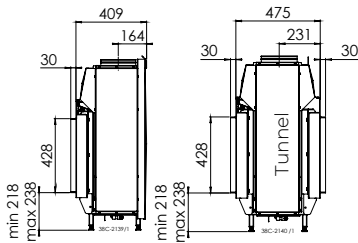
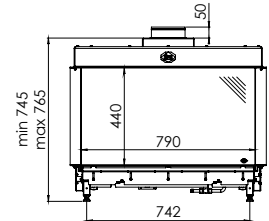
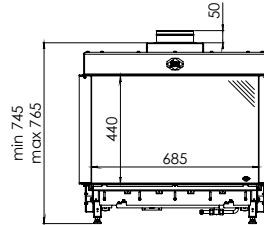
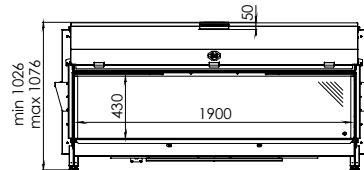
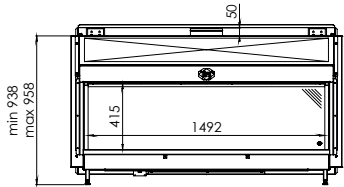
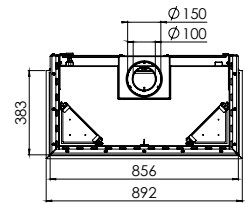
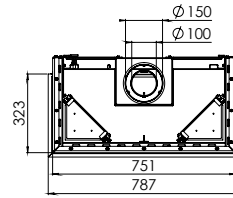
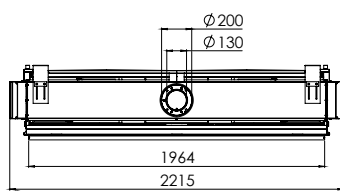
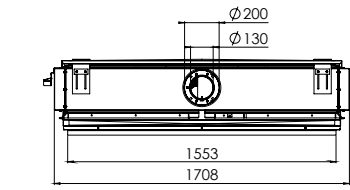

Lugo 70/2 (P. 53)

Lugo 80/2 (P. 53)

Cosmo | Tunnel (P. 56, 57)

Paco (P. 60)

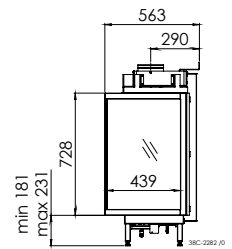
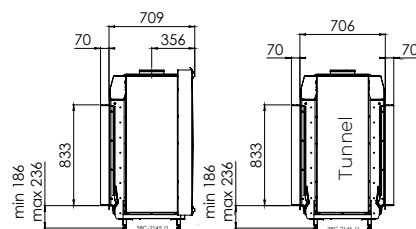
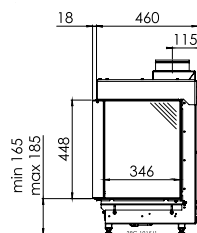
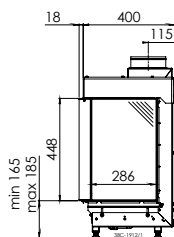
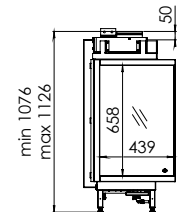
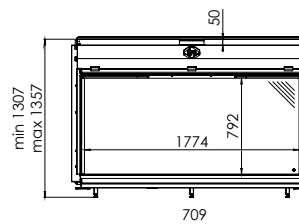
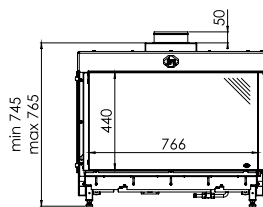
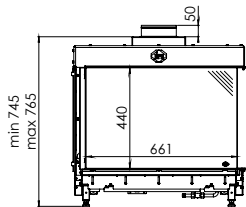
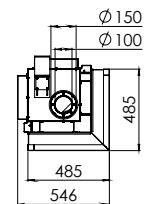
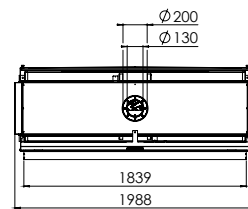
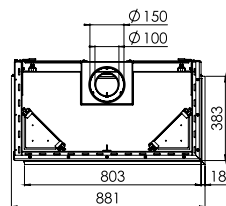
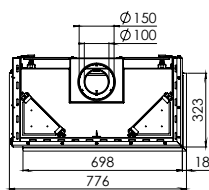

Maestro 60/3 Module (P. 64)	Passo (P. 66)	Polo (P. 68)	Diablo Next (P. 69)	Circo (P. 70)	Trio Black Edition (P. 71)
-----------------------------	---------------	--------------	---------------------	---------------	----------------------------

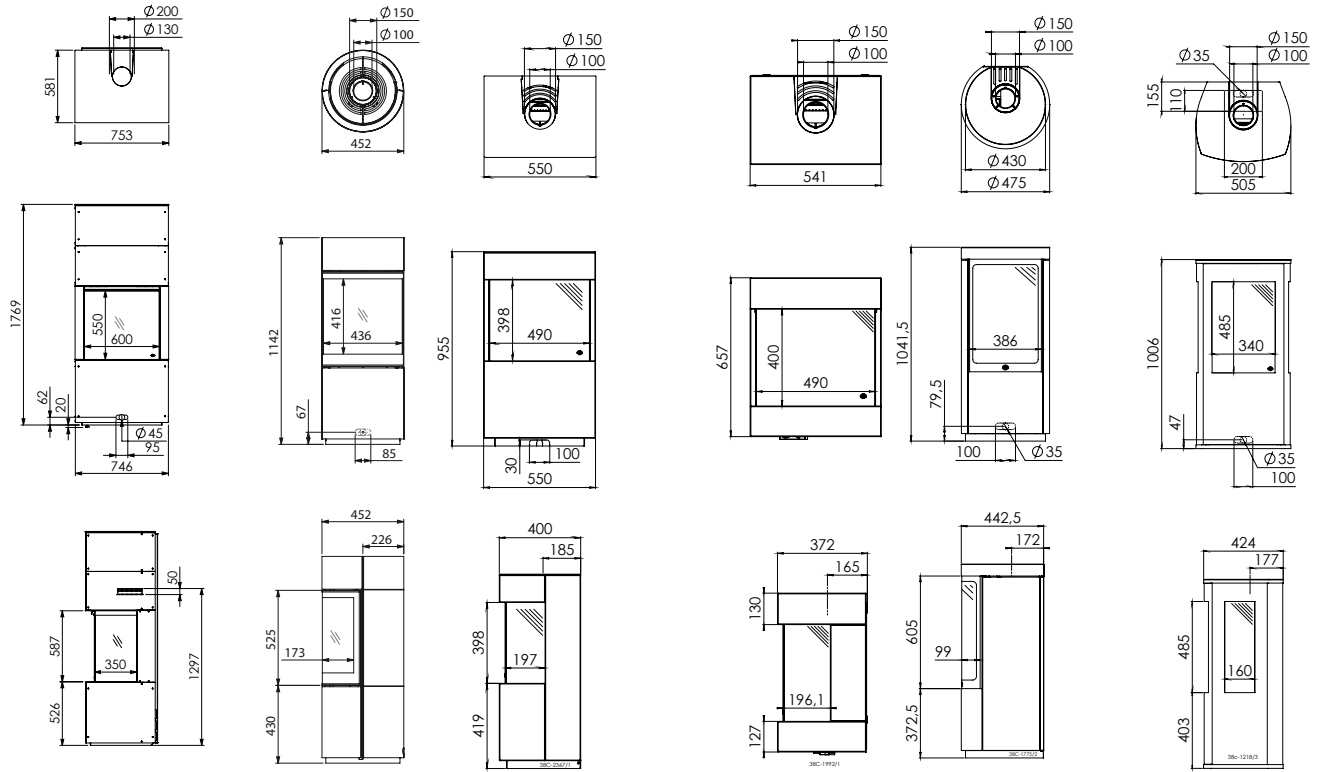

Global 60 Triple BF (P. 74)	Global 100 Triple BF (P. 75)	Global 120 Triple BF (P. 75)	Global 60 Corner BF (P. 76)
-----------------------------	------------------------------	------------------------------	-----------------------------

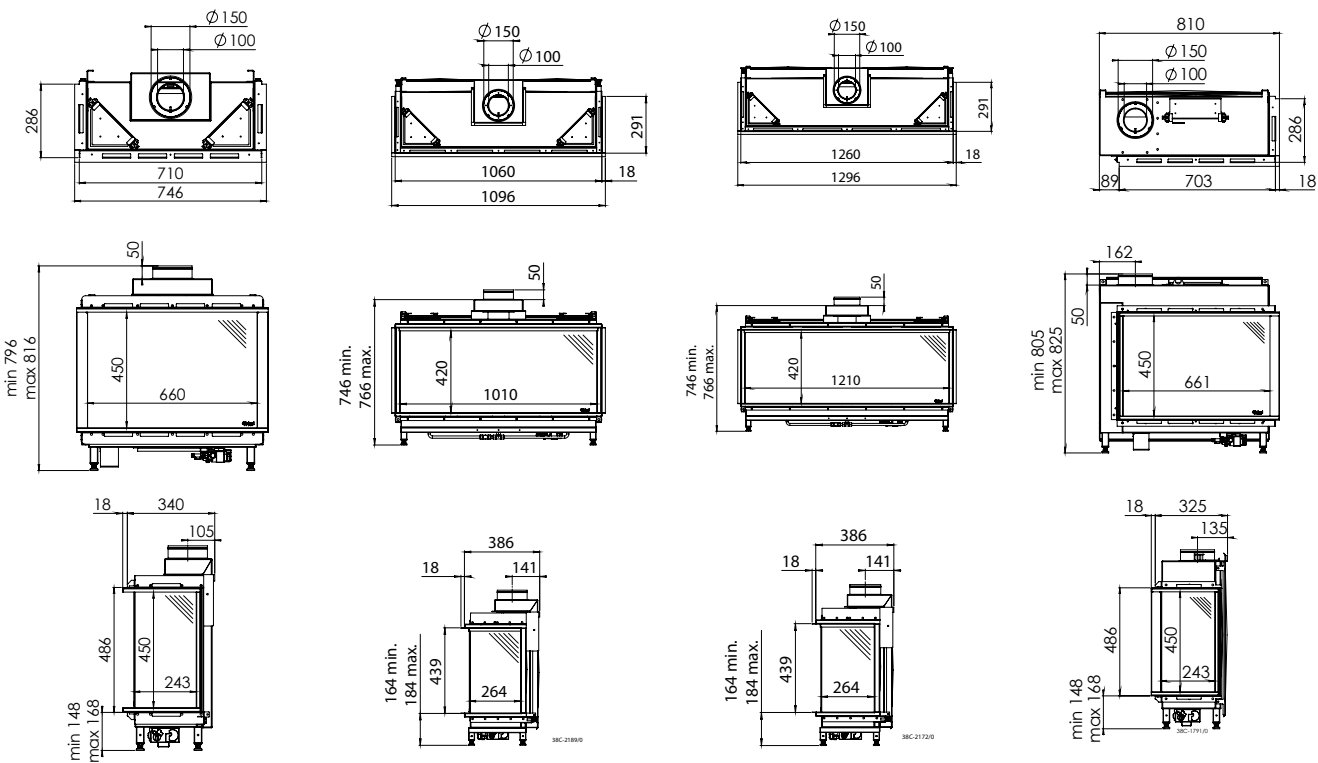

Global 100 Corner BF (P. 77)

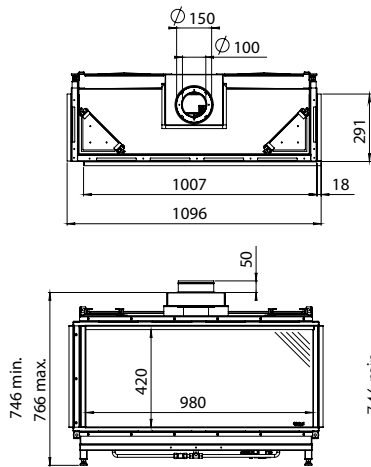

Global 120 Corner BF (P. 77)

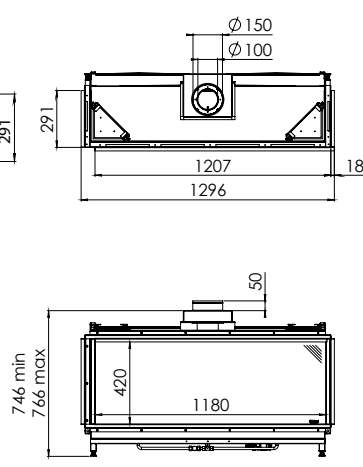

Global 55XT Cavity BF (P. 78)

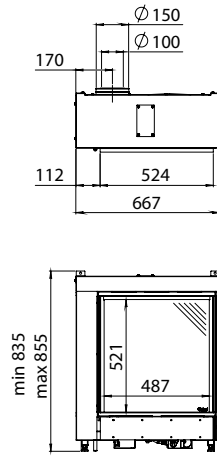

Global 55XT BF (P. 79)

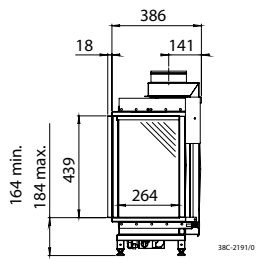
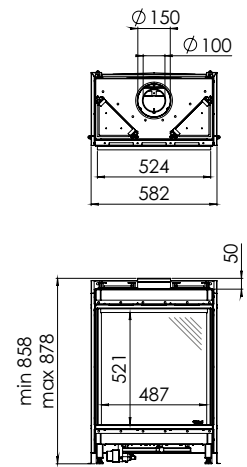

38C-21910

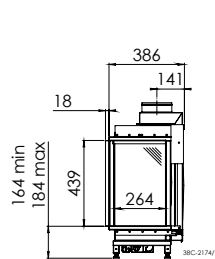

38C-21741

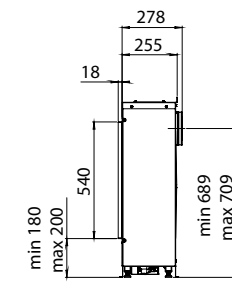

38C-23450

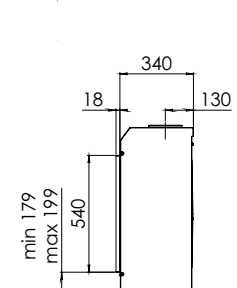

38C-25840

Global 70XT BF (P. 79)

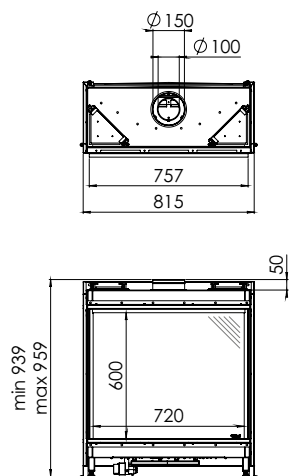

Global 100 BF | 120 BF (P. 80)

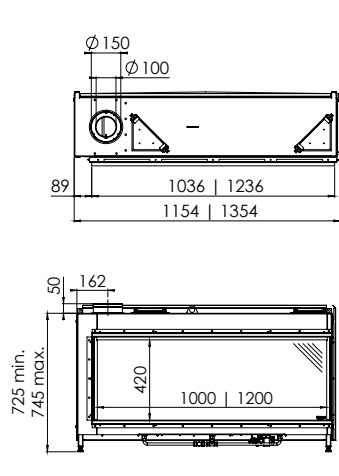

Global 55XT CF (P. 82)

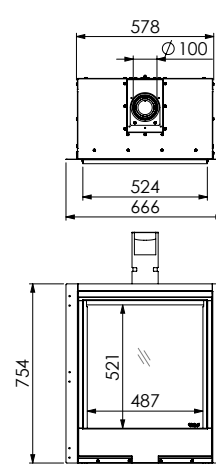

Global 70XT CF (P. 83)

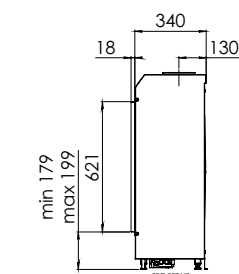
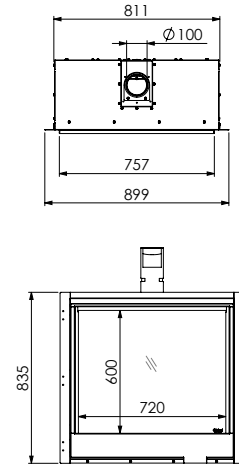

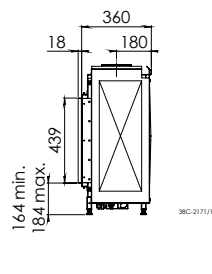

38C-25140

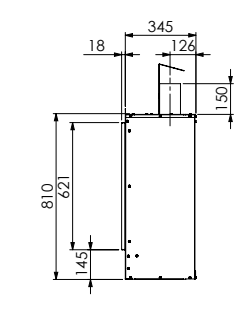
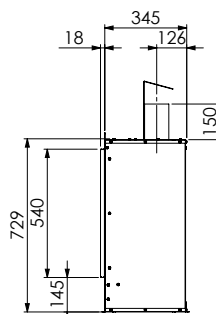

38C-21711



# caratteristiche tecniche

	Pag.	Potenza netta kW			[%] G20	Grado di efficienza			(mm)		(mm)	Profondità d'incasso	Pannello di comando (P.88)	App (P.88)	Telecomando (P.88)	RCE	RCH
		Gas naturale G20	Gas naturale G25.3 (NL)	Gas propano G31		Gas naturale G20	Gas naturale G25.3 (NL)	Gas propano G31									
<b>MAESTRO (combustione chiusa)</b>																	
Maestro 75XTU Eco Wave	16	1,2 - 8,8	1,2 - 8,4	1,9 - 9,5	93,3	A	A	A	200/130	+	545	+	+	-	+		
Maestro 60/3 Eco Wave	18	1,9 - 7,2	1,6 - 6,8	1,1 - 7,3	94,3	A	A	A	200/130	+	495	+	+	-	+		
Maestro 60/3 Tall Eco Wave	19	1,9 - 7,2	1,6 - 6,8	1,1 - 7,3	96,3	A	A	A	200/130	+	495	+	+	-	+		
Maestro 80/3 Eco Wave	20	1,4 - 9,0	1,3 - 8,6	1,4 - 7,8	93,0	A	A	A	200/130	+	492	+	+	-	+		
Maestro 105/3 Eco Wave	21	2,5 - 10,3	2,1 - 9,8	2,6 - 10,5	91,2	A	A	A	200/130	+	495	+	+	-	+		
Maestro 60/2 Eco Wave	22	1,9 - 7,2	1,6 - 6,8	1,1 - 7,3	94,3	A	A	A	200/130	+	495	+	+	-	+		
Maestro 60/2 Tall Eco Wave	23	1,9 - 7,2	1,6 - 6,8	1,1 - 7,3	96,3	A	A	A	200/130	+	495	+	+	-	+		
Maestro 80/2 Eco Wave	24	1,4 - 9,0	1,3 - 8,6	1,4 - 7,8	93,0	A	A	A	200/130	+	492	+	+	-	+		
Maestro 105/2 Eco Wave	25	2,5 - 10,3	2,1 - 9,8	2,6 - 10,5	91,2	A	A	A	200/130	+	495	+	+	-	+		
Maestro 60 Eco Wave	26	1,9 - 7,2	1,6 - 6,8	1,1 - 7,3	94,3	A	A	A	200/130	+	472	+	+	-	+		
Maestro 60 Tall Eco Wave	27	1,9 - 7,2	1,6 - 6,8	1,1 - 7,3	96,3	A	A	A	200/130	+	472	+	+	-	+		
Maestro 75 Eco Wave	28	1,3 - 9,0	1,2 - 8,6	1,3 - 7,4	89,0	A	A	A	200/130	+	400	+	+	-	+		
Maestro 75 Tall Eco Wave	29	1,7 - 9,2	1,5 - 8,7	1,5 - 8,2	91,6	A	A	A	200/130	+	400	+	+	-	+		
Maestro 100 Eco Wave	30	2,3 - 10,0	1,9 - 9,3	2,3 - 10,2	92,1	A	A	A	200/130	+	400	+	+	-	+		
Maestro 75 Tunnel Eco Wave	32	1,7 - 9,1	1,5 - 8,5	1,9 - 9,5	93,0	A	A	A	200/130	+	478	+	+	-	+		
Maestro 75 Tunnel Tall Eco Wave	33	2,0 - 10,2	1,7 - 9,5	2,0 - 10,0	92,0	A	A	A	200/130	+	478	+	+	-	+		
<b>METRO (combustione chiusa)</b>																	
Metro 100XTU Eco Wave	36	4,3 - 9,6	3,3 - 9,0	4,1 - 9,1	83,3	B	B	B	200/130	+	434	+	+	-	+		
Metro 100XTL Eco Wave	37	4,3 - 9,6	3,3 - 9,0	4,1 - 9,1	83,3	B	B	B	200/130	+	434	+	+	-	+		
Metro 130XTL Eco Wave	37	5,1 - 10,8	4,1 - 10,2	5,6 - 10,6	89,6	A	A	A	200/130	+	448	+	+	-	+		
Metro 100XT/3 Eco Wave	38	4,3 - 9,6	3,3 - 9,0	4,1 - 9,1	83,3	B	B	B	200/130	+	466	+	+	-	+		
Metro 130XT/3 Eco Wave	39	5,1 - 10,8	4,1 - 10,2	5,6 - 10,6	89,6	A	A	A	200/130	-	463	+	+	-	+		
Metro 100XT/2 Eco Wave	40	4,3 - 9,6	3,3 - 9,0	4,1 - 9,1	83,3	B	B	B	200/130	+	466	+	+	-	+		
Metro 130XT/2 Eco Wave	41	5,1 - 10,8	4,1 - 10,2	5,6 - 10,6	89,6	A	A	A	200/130	+	466	+	+	-	+		
Metro 80XT Eco Wave	42	3,0 - 5,4	2,3 - 5,1	2,8 - 5,7	88,9	A	B	A	150/100	-	379	+	+	-	+		
Metro 100XT Eco Wave	43	4,3 - 9,6	3,3 - 9,0	4,1 - 9,1	83,3	B	B	B	200/130	+	380	+	+	-	+		
Metro 130XT Eco Wave	44	5,1 - 10,8	4,1 - 10,2	5,6 - 10,6	89,6	A	A	A	200/130	-	408	+	+	-	+		
Metro 150XT Eco Wave	44	5,9 - 10,8	4,9 - 10,3	5,3 - 11,1	87,9	A	A	A	200/130	-	409	+	+	-	+		
Metro 200XT Eco Wave	45	8,9 - 16,7	7,2 - 15,8	7,3 - 15,4 <sup>1)</sup>	90,3	A	A	A	200/130	-	465	+	+	-	+		
Metro 80XT Tunnel Eco Wave	46	3,0 - 5,4	2,3 - 5,1	2,8 - 5,7	88,9	A	B	A	150/100	-	434	+	+	-	+		
Metro 100XT Tunnel Eco Wave	47	4,3 - 9,6	3,3 - 9,0	4,1 - 9,1	83,3	B	B	B	200/130	+	419	+	+	-	+		
Metro 130XT Tunnel Eco Wave	48	5,1 - 10,8	4,1 - 10,2	5,6 - 10,6	89,6	A	A	A	200/130	-	476	+	+	-	+		
Metro 150XT Tunnel Eco Wave	49	5,9 - 10,8	4,9 - 10,3	5,3 - 11,1	87,9	A	A	A	200/130	-	475	+	+	-	+		
Metro 200XT Tunnel Eco Wave	49	8,9 - 16,7	7,2 - 15,8	7,3 - 15,4 <sup>1)</sup>	90,3	A	A	A	200/130	-	467	+	+	-	+		



<sup>1)</sup> Gas propano solo in combinazione con Powervent®



(kg)	Peso	Eco Wave (P.7)	Eco Glow (P.7)	Easy release door system (P.11)	PowerVent® (P.84)	Vetro Clear View (P.10)	Interno/rivestimento interno (P.8)					Pannello da parete (P.9)	Bruciatore	Vassoio del bruciatore				
	ECO	☀	📄	PV+	Opzione	Nero	Cera-glass	Vetro matt	Rib cast	Pietra classica	Rib cast	Tipo	Set di legna marrone	Set di legna bianco	Pietre bianche	Pietre grigie	Vetro antracite	
145	+	+	-	+	+	+	+	-	-	-	-	Dynamic Flame Burner®	+	-	-	-	-	
130	+	+	+	+	+	+	+	-	-	-	-	Dynamic Flame Burner®	+	-	-	-	-	
155	+	+	+	+	-	+	+	+	-	-	-	Dynamic Flame Burner®	+	-	-	-	-	
100	+	+	-	+	+	+	+	-	+	-	+	Dynamic Flame Burner®	+	-	-	-	-	
183	+	+	+	+	+	+	+	-	+	-	+	Dynamic Flame Burner®	+	-	-	-	-	
130	+	+	+	+	+	+	+	-	-	-	-	Dynamic Flame Burner®	+	-	-	-	-	
155	+	+	+	+	-	+	+	+	-	-	-	Dynamic Flame Burner®	+	-	-	-	-	
100	+	+	-	+	+	+	+	-	+	-	+	Dynamic Flame Burner®	+	-	-	-	-	
183	+	+	+	+	+	+	+	-	+	-	+	Dynamic Flame Burner®	+	-	-	-	-	
130	+	+	+	+	+	+	+	-	-	+	-	Dynamic Flame Burner®	+	-	-	-	-	
150	+	+	+	+	+	+	+	+	-	-	-	Dynamic Flame Burner®	+	-	-	-	-	
80	+	+	+	+	+	+	+	-	+	+	+	Dynamic Flame Burner®	+	-	-	-	-	
200	+	+	+	+	+	-	+	+	-	-	-	Dynamic Flame Burner®	+	-	-	-	-	
100	+	+	+	+	+	+	+	-	+	+	+	Dynamic Flame Burner®	+	-	-	-	-	
160	+	+	+	+	+	+	-	-	-	-	-	Dynamic Flame Burner®	+	-	-	-	-	
212	+	+	+	+	+	+	+	+	-	-	-	Dynamic Flame Burner®	+	-	-	-	-	

145	+	-	-	+	+	+	+	-	-	-	-	Vario Burner	+	-	+	-	+
145	+	-	-	+	+	+	+	-	-	-	-	Vario Burner	+	-	+	-	+
160	+	-	-	+	+	+	+	-	-	-	-	Vario Burner	+	+	+	+	-
145	+	-	-	+	+	+	+	-	-	-	-	Vario Burner	+	-	+	-	+
160	+	-	-	+	+	+	+	-	-	-	-	Vario Burner	+	+	+	+	-
160	+	-	-	+	+	+	+	-	-	-	-	Vario Burner	+	-	+	-	+
160	+	-	-	+	+	+	+	-	-	-	-	Vario Burner	+	+	+	+	-
88	+	-	-	+	+	+	+	-	-	-	-	Vario Burner	+	-	+	-	-
145	+	-	+	+	+	+	+	-	-	-	-	Vario Burner	+	-	+	-	+
160	+	-	+	+	+	+	+	-	-	-	-	Vario Burner	+	+	+	+	-
160	+	-	+	+	+	-	+	-	-	-	-	Vario Burner	+	+	+	+	-
265	+	-	+	+	+	-	+	-	-	-	-	Vario Burner	+	-	+	-	+
96	+	-	-	+	+	+	-	-	-	-	-	Vario Burner	+	-	+	-	-
145	+	-	+	+	+	+	-	-	-	-	-	Vario Burner	+	-	+	-	+
160	+	-	+	+	+	+	-	-	-	-	-	Vario Burner	+	+	+	+	-
160	+	-	+	+	+	+	-	-	-	-	-	Vario Burner	+	+	+	+	-
265	+	-	+	+	+	+	-	-	-	-	-	Vario Burner	+	-	+	-	+

# Caratteristiche tecniche

	Pag.	Potenza netta kW			Grado di efficienza			Classe di efficienza energetica			Ø del canale (mm)		Direct flue (P.85) (mm)	Profondità d'incasso	Pannello di comando (P.88) App (P.88)	Telecomando (P.88)	RCE	RCH
		Gas naturale G20	Gas naturale G25.3 (NL)	Gas propano G31	(%) G20	Gas naturale G20	Gas naturale G25.3 (NL)	Gas propano G31										
<b>LUGO (combustione chiusa)</b>																		
Lugo 70/3 Eco Wave	52	3,4 - 6,9	2,8 - 6,5	3,2 - 6,3	91,0	A	A	A	150/100	-	400	-	+	-	+			
Lugo 80/3 Eco Wave	52	3,4 - 6,9	2,8 - 6,5	3,2 - 6,3	91,0	A	A	A	150/100	-	460	-	+	-	+			
Lugo 70/2 Eco Wave	53	3,4 - 6,9	2,8 - 6,5	3,2 - 6,3	91,0	A	A	A	150/100	-	400	-	+	-	+			
Lugo 80/2 Eco Wave	53	3,4 - 6,9	2,8 - 6,5	3,2 - 6,3	91,0	A	A	A	150/100	-	460	-	+	-	+			
<b>COSMO (combustione chiusa)</b>																		
Cosmo Eco Wave	56	6,0 - 16,3	4,9 - 15,7	-	89,3	A	A	-	200/130	-	709	+	+	-	+			
Cosmo Tunnel Eco Wave	57	6,0 - 16,3	4,9 - 15,7	-	89,3	A	A	-	200/130	-	706	+	+	-	+			
<b>PACO (combustione chiusa)</b>																		
Paco Eco Wave	60	2,6 - 5,4	2,1 - 5,0	-	84,8	B	C	-	150/100	-	563	+	+	-	+			
<b>INDIPENDENTE (combustione chiusa)</b>																		
Maestro 60/3 Module Eco Wave	64	1,9 - 7,2	1,6 - 6,8	1,1 - 7,3	94,3	A	A	A	200/130	+	581	-	+	-	+			
Passo Eco Wave	66	1,2 - 6,4	0,9 - 6,1	-	93,0	A	A	-	150/100	-	452	-	+	-	+			
Polo	68	1,6 - 4,1	1,5 - 3,8	1,6 - 3,8	92,6	A	A	A	150/100	-	400	-	-	+	-			
Diablo Next	69	1,6 - 4,1	1,5 - 3,8	1,6 - 3,8	92,6	A	A	A	150/100	-	372	-	-	+	-			
Circo	70	2,9 - 7,0	2,7 - 6,0	2,8 - 6,2	92,5	A	A	A	150/100	-	442	-	-	+	-			
Trio	71	2,0 - 4,5	1,8 - 4,2	1,5 - 4,0	85,4	B	B	C	150/100	-	441	-	-	+	-			
<b>GLOBAL (combustione chiusa)</b>																		
Global 60 Triple BF	74	2,3 - 6,0	2,1 - 5,4	3,0 - 6,2	91,5	A	A	A	150/100	+	340	-	-	+	-			
Global 100 Triple BF	75	2,8 - 7,5	2,6 - 7,1	3,5 - 7,0	94,0	A	A	A	150/100	+	386	-	-	+	-			
Global 120 Triple BF	75	2,8 - 7,5	2,6 - 7,1	3,5 - 7,0	94,0	A	A	A	150/100	+	386	-	-	+	-			
Global 60 Corner BF	76	2,3 - 6,0	2,1 - 5,4	3,0 - 6,2	91,5	A	A	A	150/100	+	325	-	-	+	-			
Global 100 Corner BF	77	2,8 - 7,5	2,6 - 7,1	3,5 - 7,0	94,0	A	A	A	150/100	+	386	-	-	+	-			
Global 120 Corner BF	77	2,8 - 7,5	2,6 - 7,1	3,5 - 7,0	94,0	A	A	A	150/100	+	386	-	-	+	-			
Global 55XT Cavity BF (solo UK)	78	1,8 - 3,2	-	-	77,4	C	-	-	150/100	-	255	-	-	+	-			
Global 55XT BF	79	2,6 - 4,6	2,4 - 4,3	3,1 - 4,4	92,6	A	A	A	150/100	+	340	-	-	+	-			
Global 70XT BF	79	3,4 - 5,7	3,1 - 5,3	3,2 - 5,5	92,7	A	A	A	150/100	+	340	-	-	+	-			
Global 100 BF	80	2,8 - 7,5	2,6 - 7,1	3,5 - 7,0	94,0	A	A	A	150/100	+	360	-	-	+	-			
Global 120 BF	80	2,8 - 7,5	2,6 - 7,1	3,5 - 7,0	94,0	A	A	A	150/100	+	360	-	-	+	-			
<b>GLOBAL (combustione aperta)</b>																		
Global 55XT CF	82	2,8 - 3,7	2,6 - 3,5	-	74,4	D	D	-	100	-	345	-	-	+	-			
Global 70XT CF	83	3,1 - 4,5	2,7 - 4,4	4,0 - 4,6	77,1	C	D	D	100	-	345	-	-	+	-			

I modelli di fiamma dei caminetti con combustibili differenti sono diversi.

(kg)	Peso				Eco Wave (P.7)		Eco Glow (P.7)		Easy release door system (P.11)		PowerVent® (P.84)		Vetro Clear View (P.10)		Interno/rivestimento interno (P.8)		Pannello da parete (P.9)		Bruciatore		Vassoio del bruciatore	
	ECO	ECO	ECO	ECO	Opzione	Nero	Cera-glass	Vetro matt	Rib cast	Pietra classica	Rib cast	Tipo	Set di legna marrone	Set di legna bianco	Pietre bianche	Pietre grigie	Vetro antracite					
85	+	-	-	+	-	+	+	-	-	-	-	Vario Burner	+	-	-	-	-					
96	+	-	-	+	-	+	+	-	-	-	-	Vario Burner	+	-	-	-	-					
85	+	-	-	+	-	+	+	-	-	-	-	Vario Burner	+	-	-	-	-					
96	+	-	-	+	-	+	+	-	-	-	-	Vario Burner	+	-	-	-	-					
350	+	-	+	+	+	+	-	-	-	-	-	Vario Burner	+	-	-	-	-					
350	+	-	+	+	+	+	-	-	-	-	-	Vario Burner	+	-	-	-	-					
70	+	-	-	+	-	-	+	-	-	-	-	Line Burner	+	-	-	-	-					
160	+	+	+	-	+	+	+	-	-	-	-	Dynamic Flame Burner®	+	-	-	-	-					
95	+	-	+	-	-	+	-	-	-	-	-	Dynamic Flame Burner®	+	-	-	-	-					
68	-	-	-	-	-	+	+	-	-	-	-	Line Burner	+	-	-	-	-					
48	-	-	-	-	-	+	+	-	-	-	-	Line Burner	+	-	-	-	-					
110	-	-	-	-	-	+	-	-	-	-	-	Line Burner	+	-	-	-	-					
80	-	-	-	-	-	-	+	-	-	-	-	Line Burner	+	-	-	-	-					
65	-	-	-	-	-	+	+	-	-	-	-	Line Burner	+	-	+	-	-					
100	-	-	-	-	-	+	+	-	-	-	-	Line Burner	+	-	+	-	+					
120	-	-	-	-	-	+	+	-	-	-	-	Line Burner	+	-	+	-	+					
62	-	-	-	-	-	+	+	-	-	-	-	Line Burner	+	-	-	-	-					
100	-	-	-	-	-	+	+	-	-	-	-	Line Burner	+	-	-	-	-					
120	-	-	-	-	-	+	+	-	-	-	-	Line Burner	+	-	+	-	+					
40	-	-	-	-	+	-	+	-	-	-	-	Truflame Burner®	+	-	-	-	-					
90	-	-	-	-	+	+	+	-	-	+	-	Truflame Burner®	+	-	-	-	-					
103	-	-	-	-	+	+	+	-	-	+	-	Truflame Burner®	+	-	-	-	-					
75	-	-	-	-	-	+	+	-	-	-	-	Line Burner	+	-	+	-	+					
120	-	-	-	-	-	+	+	-	-	-	-	Line Burner	+	-	+	-	+					
43	-	-	-	-	+	+	+	-	-	+	-	Truflame Burner®	+	-	-	-	-					
63	-	-	-	-	+	+	+	-	-	+	-	Truflame Burner®	+	-	-	-	-					

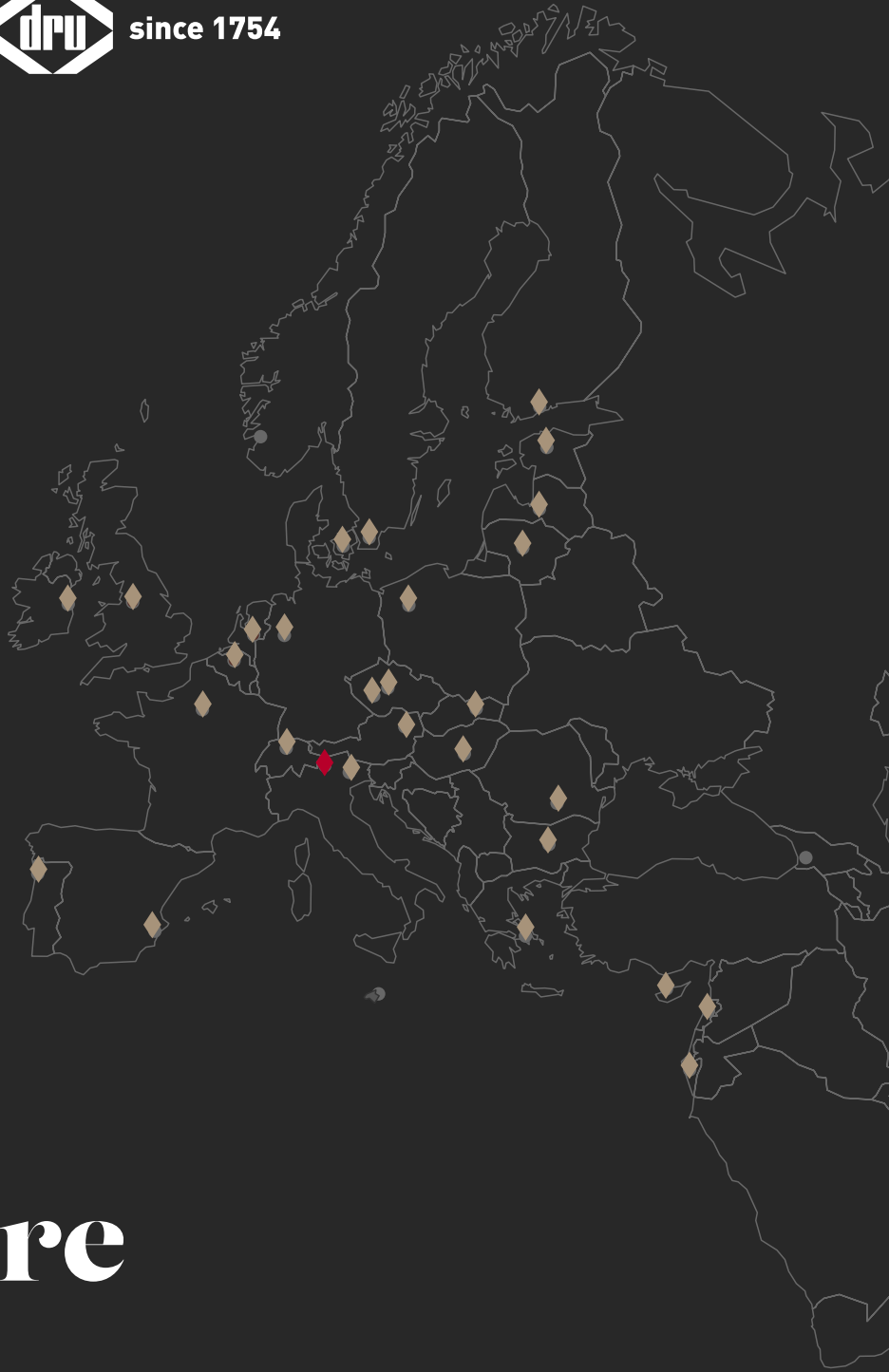

# *i am* everywhere



Spartherm Distribution Italia Srl  
Via Enrico Fermi, 11  
I-39100 Bozen Italia  
T. +39 (0)471 050290  
F. +39 (0)471 050291  
E. info-it@spartherm.com

DRU Verwarming B.V.  
P.O. Box 1021 | 6920 BA Duiven  
Ratio 8 | 6921 RW Duiven  
The Netherlands  
T. +31 (0)26 - 319 5 319  
www.dru.nl



[www.drufire.com](http://www.drufire.com)

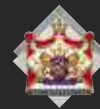

BY APPOINTMENT OF  
THE COURT OF THE NETHERLANDS



DRU: Member of the Spartherm-Group

Soggetto a modifiche. I colori nella brochure potrebbero essere diversi.

Nulla di quanto contenuto in questa edizione può essere usato senza il consenso scritto di DRU Verwarming B.V.

SOCIAL MEDIA :

Per maggiore ispirazione e informazioni guardate uno dei nostri canali social oppure scansionate il codice QR

