



*lifestyle Home*

- CATALOGO TECNICO -

# *lifestyle Home*



## - CATALOGO TECNICO -

DOUBLÉ.....	3
PUSH&GO.....	17
QUADRANTE.....	21
OPENKIT.....	47
GLOSSY.....	53
MULTIUSO.....	59



CODICE	DIMENSIONI	INTERNO / ACCESSORI	RIPIANI DI SERIE	VOLUME PZ x PALLET	PESO L PESO N
<b>Db270</b>	<b>H110 L71 P41</b> cm struttura sp. 25 mm		<b>H102 L66 P37</b> cm 2 cod. <b>118/P</b>	0,342 mc <b>H109 L73 P43</b> cm 6	41,2 kg 40,4 kg

**Db270k kit**

	<b>H110 L71 P41</b> cm struttura sp. 25 mm		<b>H102 L66 P37</b> cm 2 cod. <b>118/P</b>	0,098 mc <b>H112 L44 P20</b> cm 12	41,7 kg 40,4 kg
---	---	---	--	--	--------------------

**Db320k kit**

	<b>H144 L150 P37</b> cm struttura sp. 25 mm		<b>H132 L140 P37</b> cm	0,103 mc <b>H152 L40 P17</b> cm 14	54,2 kg 52,6 kg
---	--	---	-------------------------	--	--------------------

**Db324k kit**

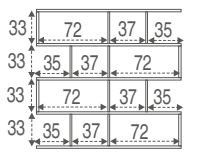
	<b>H144 L150 P37</b> cm struttura sp. 25 mm		<b>H132 L144 P37/35</b> cm	0,103 mc TOP <b>H152 L40 P17</b> cm 14	41,5 kg 40,5 kg
				0,067 mc BASE <b>H152 L40 P11</b> cm 20	34,3 kg 33,1 kg

**Db325k kit**

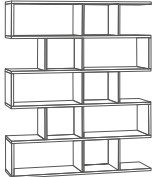
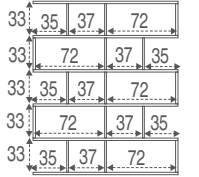
	<b>H178 L150 P37</b> cm struttura sp. 25 mm		<b>H165 L144 P37/35</b> cm	0,103 mc TOP <b>H152 L40 P17</b> cm 14	41,5 kg 40,5 kg
				0,103 mc BASE <b>H152 L40 P17</b> cm 14	50,5 kg 49,3 kg

**Db326k kit**

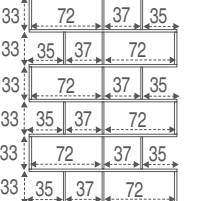
	<b>H215 L150 P37</b> cm struttura sp. 25 mm		<b>H198 L144 P37/35</b> cm	0,103 mc TOP <b>H152 L40 P17</b> cm 14	41,5 kg 40,5 kg
				0,067 mc BASE (x2) <b>H152 L40 P11</b> cm 20	34,3 kg 33,1 kg

**RIPIANI e ACCESSORI**

CODICE	DIMENSIONI	FINITURA
<b>118/P</b>	<b>H65,9 L36,0 Sp1,4</b> cm	Bianco Liscio

CODICE	DIMENSIONI	FINITURA
<b>Ca0576</b> 4 pz 2pz con fermo	<b>H8 L6,5 P3,5</b> cm	Grigio Satinato

**E ESSENZA**

Configurazione Maniglie e piedini cromo satinati.  
Standard

**FINITURE STRUTTURA**

- Cemento  
**E** - Noce Stelvio  
- Ossido Bianco

**FINITURE FRONTALI**

- Cemento  
**E** - Noce Stelvio  
- Ossido Bianco  
- Ossido Nero

- Cemento  
**E** - Noce Stelvio  
- Ossido Bianco

- Cemento  
**E** - Noce Stelvio  
- Ossido Bianco  
- Ossido Nero

**E** - Cemento  
- Ossido Bianco

**E** - Cemento  
- Ossido Bianco







**E** - Cemento  
- Ossido Bianco

**E** - Cemento  
- Ossido Bianco

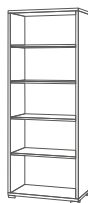
**E** - Cemento  
- Ossido Bianco

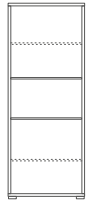
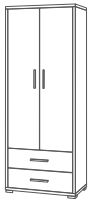
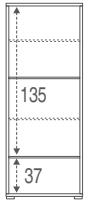
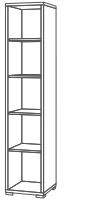
**E** - Cemento  
- Ossido Bianco

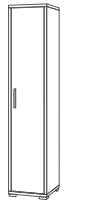
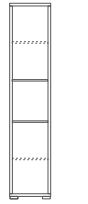
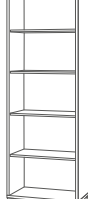
**E** - Cemento  
- Ossido Bianco

CODICE	DIMENSIONI	INTERNO / ACCESSORI	RIPIANI DI SERIE	VOLUME PZ x PALLET	PESO L PESO N
<b>Db351k</b> <b>Kit</b>	 H182 L71 P41 cm struttura sp. 25 mm		H174 L66 P37 cm 2 cod. 151/P 2 tramezze orizzontali fisse regolabili in altezza	0,105 mc H183 L44 P13 cm 18	48,1 kg 46,4 kg
<b>Db354k</b> <b>Kit</b>	 H182 L71 P41 cm struttura sp. 25 mm		H174 L66 P37 cm 2 cod. 151/P 2 tramezze orizzontali fisse regolabili in altezza	STRUTTURA 0,105 mc H183 L44 P13 cm 18 FRONTALI 0,033 mc H187 L35 P5 cm 48	48,1 kg 46,4 kg 15,2 kg 13,8 kg
<b>Db359k</b> <b>Kit</b>	 H182 L71 P41 cm struttura sp. 25 mm	 135 37	H174 L66 P37 cm guide a rullo cassetto H16 L61 P34 cm 2 cod. 151/P 2 tramezze orizzontali fisse (di cui 1 regolabile in altezza)	STRUTTURA 0,105 mc H183 L44 P13 cm 18 FRONTALI 0,058 mc H158 L46 P8 cm 30	48,1 kg 46,4 kg 20,6 kg 19,1 kg
<b>Db361k</b> <b>Kit</b>	 H182 L39 P41 cm struttura sp. 25 mm		H174 L34 P37 cm 2 cod. 152/P 2 tramezze orizzontali fisse regolabili in altezza	0,105 mc H184 L44 P13 cm 18	35,1 kg 33,5 kg
<b>Db364k</b> <b>Kit</b>	 H182 L39 P41 cm struttura sp. 25 mm		H174 L34 P37 cm 2 cod. 152/P 2 tramezze orizzontali fisse regolabili in altezza	0,105 mc H184 L44 P13 cm 18	42,1 kg 40,5 kg
<b>Db371k</b> <b>Kit</b>	 H199 L71 P41 cm struttura sp. 25 mm		H191 L66 P37 cm 2 cod. 151/P 2 tramezze orizzontali fisse regolabili in altezza	0,157 mc H203 L43 P18 cm 14	50,8 kg 48,9 kg

RIPIANI e ACCESSORI

CODICE	DIMENSIONI	FINITURA	CODICE	DIMENSIONI	FINITURA
<b>151/P</b>	 H65,8 L37,4 Sp1,8 cm	Cemento Ossido Bianco Noce Stelvio	<b>152/P</b>	 H32,8 L37,4 Sp1,8 cm	Cemento Ossido Bianco Noce Stelvio

E ESSENZA

FINITURE STRUTTURA

- Cemento
- E** - Noce Stelvio
- Ossido Bianco

FINITURE FRONTALI

- Cemento
- E** - Noce Stelvio
- Ossido Bianco

- Cemento
- E** - Noce Stelvio
- Ossido Bianco
- Ossido Nero

- Cemento
- E** - Noce Stelvio
- Ossido Bianco

- Cemento
- E** - Noce Stelvio
- Ossido Bianco
- Ossido Nero

- Cemento
- E** - Noce Stelvio
- Ossido Bianco

- Cemento
- E** - Noce Stelvio
- Ossido Bianco

- Cemento
- E** - Noce Stelvio
- Ossido Bianco
- Ossido Nero



- Cemento
- E** - Noce Stelvio
- Ossido Bianco

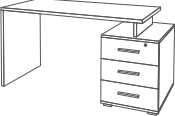

CODICE	DIMENSIONI	INTERNO / ACCESSORI	RIPIANI DI SERIE	VOLUME PZ x PALLET	PESO L PESO N
<b>Db374k</b> <b>Kit</b>	<b>H199 L71 P41</b> cm struttura sp. <b>25 mm</b>		<b>H191 L66 P37</b> cm 2 cod. <b>151/P</b> 2 tramezze orizzontali fisse regolabili in altezza	0,157 mc <b>H203 L43 P18</b> cm 14	65,3 kg 63,4 kg

<b>Db381k</b> <b>Kit</b>	<b>H199 L39 P41</b> cm struttura sp. <b>25 mm</b>		<b>H191 L34 P37</b> cm 2 cod. <b>152/P</b> 2 tramezze orizzontali fisse regolabili in altezza	0,157 mc <b>H203 L43 P18</b> cm 14	37,7 kg 35,9 kg
--------------------------	--	---	---	--	--------------------

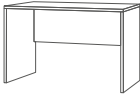
<b>Db384k</b> <b>Kit</b>	<b>H199 L39 P41</b> cm struttura sp. <b>25 mm</b>		<b>H191 L34 P37</b> cm 2 cod. <b>152/P</b> 2 tramezze orizzontali fisse regolabili in altezza	0,157 mc <b>H203 L43 P18</b> cm 14	44,1 kg 42,5 kg
--------------------------	--	---	---	--	--------------------

<b>Db625k</b> <b>Kit</b>	<b>H76 L154 P65</b> cm struttura sp. <b>25 mm</b>	 <b>guide a rullo cassetto</b> <b>H14 L41 P34</b> cm	1 cassetto con chiave	0,134 mc <b>H143 L67 P14</b> cm 8	59,0 kg 57,5 kg
--------------------------	--	---	-----------------------	---	--------------------

<b>Db628k</b> <b>Kit</b>	<b>H76 L120 P69</b> cm struttura sp. <b>25 mm</b>	 40 33	 64	0,088 mc <b>H153 L82 P7</b> cm 16	39,0 kg 37,6 kg
--------------------------	--	---	---	---	--------------------

<b>Db629k</b> <b>Kit</b>	<b>H76 L160 P69</b> cm struttura sp. <b>25 mm</b>	 40 33	 64	0,121 mc <b>H184 L73 P9</b> cm 14	43,6 kg 41,5 kg
--------------------------	--	---	---	---	--------------------

RIPIANI e ACCESSORI

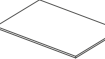
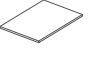
CODICE	DIMENSIONI	FINITURA	CODICE	DIMENSIONI	FINITURA
<b>151/P</b>	 <b>H65,8 L37,4 Sp1,8</b> cm	Cemento Ossido Bianco Noce Stelvio	<b>152/P</b>	 <b>H32,8 L37,4 Sp1,8</b> cm	Cemento Ossido Bianco Noce Stelvio

E ESSENZA

Configurazione Maniglie e piedini cromo satinati.  
Standard

FINITURE STRUTTURA

- Cemento  
**E** - Noce Stelvio  
- Ossido Bianco

- Cemento  
**E** - Noce Stelvio  
- Ossido Bianco

- Cemento  
**E** - Noce Stelvio  
- Ossido Bianco

- Cemento  
**E** - Noce Stelvio  
- Ossido Bianco

- Cemento  
**E** - Noce Stelvio  
- Ossido Bianco

- Cemento  
**E** - Noce Stelvio  
- Ossido Bianco

FINITURE FRONTALI

- Cemento  
**E** - Noce Stelvio  
- Ossido Bianco  
- Ossido Nero

- Cemento  
**E** - Noce Stelvio  
- Ossido Bianco  
- Ossido Nero

**STRUTTURA**  
- Cemento  
**FRONTALI**  
- Ossido Bianco

**E**  
**STRUTTURA**  
- Noce Stelvio  
**FRONTALI**  
- Ossido Nero

CODICE	DIMENSIONI	INTERNO / ACCESSORI	RIPIANI DI SERIE	VOLUME PZ x PALLET	PESO L PESO N
<b>Db6292dk kit</b>	<b>H76 L160 P150 cm</b> struttura sp. 25 mm			SCRIVANIA 0,121 mc <b>H184 L73 P9 cm</b> 14	43,6 kg 41,5 kg
<b>Db6292sk kit</b>	<b>H76 L160 P150 cm</b> struttura sp. 25 mm			SCRIVANIA 0,121 mc <b>H184 L73 P9 cm</b> 14	43,6 kg 41,5 kg
<b>Db630k kit</b>	<b>H76 L180 P69 cm</b> struttura sp. 25 mm			ANGOLO 0,090 mc <b>H176 L73 P7 cm</b> 14	29,9 kg 28,8 kg
<b>Db6301dk kit</b>	<b>H76 L180 P169 cm</b> struttura sp. 25 mm			SCRIVANIA 0,121 mc <b>H184 L73 P9 cm</b> 14	46,8 kg 44,2 kg
<b>Db6301sk kit</b>	<b>H76 L180 P169 cm</b> struttura sp. 25 mm			ANGOLO 0,090 mc <b>H176 L73 P7 cm</b> 14	31,8 kg 30,4 kg
<b>Db733</b>	<b>H71 L51 P41 cm</b> struttura sp. 25 mm		<b>H57 L46 P37 cm</b> guide a rullo cassetto <b>H16 L41 P34 cm</b> 1 cassetto con chiave	0,148 mc <b>H66 L52 P43 cm</b> 12	26,7 kg 26,2 kg

RIPIANI e ACCESSORI

CODICE	DIMENSIONI	FINITURA
<b>Ca0576 4 pz</b> 2pz con fermo	<b>H8 L6,5 P3,5 cm</b>	Grigio Satinato

E ESSENZA

Configurazione Maniglie e piedini cromo satinati.  
Standard

FINITURE STRUTTURA

- Cemento
- E** - Noce Stelvio
- Ossido Bianco

- Cemento
- E** - Noce Stelvio
- Ossido Bianco

- Cemento
- E** - Noce Stelvio
- Ossido Bianco

- Cemento
- E** - Noce Stelvio
- Ossido Bianco

- Cemento
- E** - Noce Stelvio
- Ossido Bianco

- Cemento
- E** - Noce Stelvio
- Ossido Bianco

FINITURE FRONTALI

- Cemento
- E** - Noce Stelvio
- Ossido Bianco
- Ossido Nero

CODICE	DIMENSIONI	INTERNO / ACCESSORI	RIPIANI DI SERIE	VOLUME PZ x PALLET	PESO L PESO N
<b>Db774</b>	<b>H110 L71 P41</b> cm struttura sp. 25 mm		<b>H102 L66 P37</b> cm guide a rullo cassetto <b>H22 L61 P34</b> cm	0,342 mc <b>H109 L73 P43</b> cm 6	43,5 kg 42,7 kg
<b>Db774k</b> <b>kit</b>	<b>H110 L71 P41</b> cm struttura sp. 25 mm		<b>H102 L66 P37</b> cm guide a rullo cassetto <b>H22 L61 P34</b> cm	0,098 mc <b>H112 L44 P20</b> cm 12	44,6 kg 42,7 kg
<b>Db801</b>	<b>H57 L139 P41</b> cm struttura sp. 25 mm		<b>H48 L132 P37</b> cm guide a rullo cassetto <b>H22 L61 P34</b> cm	2 tramezze orizzontali fisse 1 tramezza verticale fissa 0,346 mc <b>H57 L141 P43</b> cm 5	46,4 kg 45,2 kg
<b>Db802k</b> <b>kit</b>	<b>H84 L174 P41</b> cm struttura sp. 25 mm		<b>H76 L165 P37</b> cm guide a rullo cassetto <b>H22 L61 P34</b> cm	2 cod. <b>137/P</b> 1 tramezza orizzontale fissa 2 tramezze verticali fisse 0,123 mc <b>H178 L53 P13</b> cm 10	52,0 kg 50,0 kg
<b>Db804k</b> <b>kit</b>	<b>H84 L174 P41</b> cm struttura sp. 25 mm		<b>H76 L165 P37</b> cm guide a rullo cassetto <b>H16 L61 P34</b> cm	2 cod. <b>137/P</b> 2 tramezze verticali fisse 0,123 mc <b>H178 L53 P13</b> cm 10	51,8 kg 49,8 kg
<b>Db805k</b> <b>kit</b>	<b>H50 L179 P47</b> cm struttura sp. 25 mm		<b>H42 L172 P33</b> cm guide a rullo cassetto superiore <b>H13 L81 P39</b> cm cassetto inferiore <b>H22 L81 P39</b> cm	1 tramezza verticale fissa 0,129 mc <b>H187 L53 P13</b> cm 10	60,1 kg 58,2 kg

RIPIANI e ACCESSORI

CODICE	DIMENSIONI	FINITURA
<b>137/P</b>	<b>H49,6 L36,4 Sp1,0</b> cm	Bianco Liscio

CODICE	DIMENSIONI	FINITURA
<b>Ca0576</b> <b>4 pz</b> 2pz con fermo	<b>H8 L6,5 P3,5</b> cm	Grigio Satinato

E ESSENZA

Configurazione Maniglie e piedini cromo satinati.  
Standard

FINITURE STRUTTURA

- Cemento
- E** - Noce Stelvio
- Ossido Bianco

FINITURE FRONTALI

- Cemento
- E** - Noce Stelvio
- Ossido Bianco
- Ossido Nero

- Cemento
- E** - Noce Stelvio
- Ossido Bianco

- Cemento
- E** - Noce Stelvio
- Ossido Bianco
- Ossido Nero

- Cemento
- E** - Noce Stelvio
- Ossido Bianco

- Cemento
- E** - Noce Stelvio
- Ossido Bianco
- Ossido Nero

- Cemento
- E** - Noce Stelvio
- Ossido Bianco

- Cemento
- E** - Noce Stelvio
- Ossido Bianco
- Ossido Nero



- Cemento
- E** - Noce Stelvio
- Ossido Bianco



- Cemento
- E** - Noce Stelvio
- Ossido Bianco
- Ossido Nero

- Cemento
- E** - Noce Stelvio
- Ossido Bianco

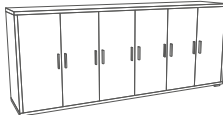
- Cemento
- E** - Noce Stelvio
- Ossido Bianco
- Ossido Nero



CODICE	DIMENSIONI	INTERNO / ACCESSORI	RIPIANI DI SERIE	VOLUME PZ x PALLET	PESO L PESO N
<b>Db806k</b> <b>kit</b>	 <b>H84 L203 P41</b> cm struttura sp. <b>25 mm</b>	 <b>H76 L194 P37</b> cm	<b>3</b> cod. <b>145/P - 146/P</b> 2 tramezze verticali fisse	<b>STRUTTURA</b> 0,107 mc <b>H208 L43 P12</b> cm 20 <b>FRONTALI</b> 0,043 mc <b>H89 L40 P12</b> cm 20	57,0 kg 55,0 kg 31,0 kg 29,5 kg

<b>Db808k</b> <b>kit</b>	 <b>H84 L203 P41</b> cm struttura sp. <b>25 mm</b>	 <b>H76 L194 P37</b> cm <b>guide a rullo</b> cassetto <b>H16 L61 P34</b> cm	<b>2</b> cod. <b>145/P</b> 2 tramezze verticali fisse	<b>STRUTTURA</b> 0,107 mc <b>H208 L43 P12</b> cm 20 <b>FRONTALI</b> 0,064 mc <b>H105 L36 P17</b> cm 14	57,0 kg 55,0 kg 34,5 kg 33,0 kg
--------------------------	---	--	--	---	--

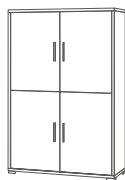
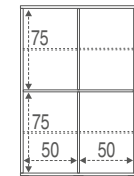
<b>Db834k</b> <b>kit</b>	 <b>H161 L108 P41</b> cm struttura sp. <b>25 mm</b>	 <b>H151 L101 P37</b> cm	<b>4</b> cod. <b>136/P</b> 1 tramezza orizzontale fissa 2 tramezze verticali fisse	<b>STRUTTURA</b> 0,104 mc <b>H157 L44 P15</b> cm 16 <b>FRONTALI</b> 0,053 mc <b>H82 L54 P12</b> cm 20	52,0 kg 50,5 kg 22,9 kg 21,4 kg
--------------------------	--	--	--	--	--

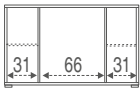
<b>Db875</b>	 <b>H84 L137 P41</b> cm struttura sp. <b>25 mm</b>	 <b>H76 L128 P37</b> cm <b>guide a rullo</b> cassetto <b>H16 L61 P34</b> cm	<b>2</b> cod. <b>133/P</b> 2 tramezze verticali fisse	0,496 mc <b>H83 L139 P43</b> cm 5	65,9 kg 64,5 kg
--------------	---	--	--	---	--------------------

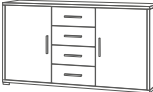
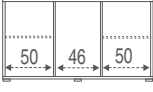
<b>Db879</b>	 <b>H84 L154 P41</b> cm struttura sp. <b>25 mm</b>	 <b>H76 L145 P37</b> cm <b>guide a rullo</b> cassetto <b>H16 L41 P34</b> cm	<b>2</b> cod. <b>137/P</b> 2 tramezze verticali fisse	0,557 mc <b>H83 L156 P43</b> cm 3	79,2 kg 77,5 kg
--------------	---	--	--	---	--------------------

RIPIANI e ACCESSORI

CODICE	DIMENSIONI	FINITURA
<b>133/P</b>	 <b>H31,0 L36,4 Sp1,0</b> cm	Bianco Liscio
<b>137/P</b>	 <b>H49,6 L36,4 Sp1,0</b> cm	Bianco Liscio

CODICE	DIMENSIONI	FINITURA
<b>136/P</b>	 <b>H50,3 L36,4 Sp1,0</b> cm	Bianco Liscio

E ESSENZA

Configurazione Maniglie e piedini cromo satinati.  
Standard

FINITURE STRUTTURA

- Cemento  
**E** - Noce Stelvio  
- Ossido Bianco

FINITURE FRONTALI

- Cemento  
**E** - Noce Stelvio  
- Ossido Bianco  
- Ossido Nero

- Cemento  
**E** - Noce Stelvio  
- Ossido Bianco

- Cemento  
**E** - Noce Stelvio  
- Ossido Bianco  
- Ossido Nero

- Cemento  
**E** - Noce Stelvio  
- Ossido Bianco

- Cemento  
**E** - Noce Stelvio  
- Ossido Bianco  
- Ossido Nero

- Cemento  
**E** - Noce Stelvio  
- Ossido Bianco

- Cemento  
**E** - Noce Stelvio  
- Ossido Bianco  
- Ossido Nero

- Cemento  
**E** - Noce Stelvio  
- Ossido Bianco

- Cemento  
**E** - Noce Stelvio  
- Ossido Bianco  
- Ossido Nero

RIPIANI e ACCESSORI



CODICE	DIMENSIONI	FINITURA
<b>145/P</b>	 <b>H65,7 L36,4 Sp1,0</b> cm	Bianco Liscio

CODICE	DIMENSIONI	FINITURA
<b>146P</b>	 <b>H64,2 L36,4 Sp1,0</b> cm	Bianco Liscio

*Push and Go*  
- COLLECTION -

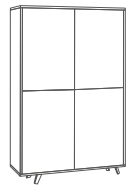
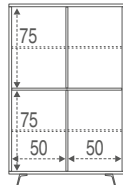
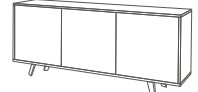

- LISTINO TECNICO -

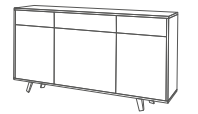
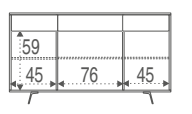
CODICE	DIMENSIONI	INTERNO / ACCESSORI	RIPIANI DI SERIE	VOLUME PZ x PALLET	PESO L PESO N
<b>7034k</b> <b>kit</b>	 H169 L107 P41 cm struttura sp. 18 mm	 H151 L101 P37 cm	4 cod. <b>136/P</b> 1 tramezza orizzontale fissa 2 tramezze verticali fisse	STRUTTURA 0,104 mc H157 L44 P15 cm 16 FRONTALI 0,053 mc H82 L54 P12 cm 20	52,0 kg 50,0 kg 25,6 kg 24,2 kg
<b>7073k</b> <b>kit</b>	 H74 L177 P41 cm struttura sp. 18 mm	 H57 L175 P37 cm	2 cod. <b>142/P - 144/P</b> 1 tramezza verticale fissa	0,121 mc H180 L61 P11 cm 10	48,9 kg 47,1 kg
<b>7076k</b> <b>kit</b>	 H92 L164 P41 cm struttura sp. 18 mm	 H76 L160 P37 cm	3 cod. <b>138/P - 145/P</b> 2 tramezze verticali fisse	0,171 mc H170 L63 P16 cm 8	60,0 kg 58,2 kg

E ESSENZA

L LACCATO

Configurazione Push-pull su ante e cassetti. Piedini cromo satinati.  
Standard

FINITURE STRUTTURA

- Cemento  
E - Ossido Bianco  
- Ossido Nero

- Cemento  
E - Ossido Bianco  
- Ossido Nero

- Cemento  
E - Ossido Bianco  
- Ossido Nero

- Cemento  
E - Ossido Bianco  
- Ossido Nero

- Cemento  
E - Ossido Bianco  
- Ossido Nero

- Cemento  
E - Ossido Bianco  
- Ossido Nero

FINITURE FRONTALI

- Marmo Calacatta  
E - Ossido Bianco  
- Ossido Nero

L - Bianco Lucido

- Marmo Calacatta  
E - Ossido Bianco  
- Ossido Nero

L - Bianco Lucido

- Marmo Calacatta  
E - Ossido Bianco  
- Ossido Nero

L - Bianco Lucido

RIPIANI e ACCESSORI

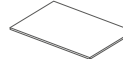
CODICE	DIMENSIONI	FINITURA	CODICE	DIMENSIONI	FINITURA
<b>136/P</b>	H50,3 L36,4 Sp1,0 cm	Bianco Liscio	<b>142/P</b>	H57,1 L36,74 Sp1,4 cm	Bianco Liscio
			<b>144/P</b>	H113,5 L36,4 Sp1,4 cm	Bianco Liscio
					

RIPIANI e ACCESSORI

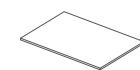

CODICE	DIMENSIONI	FINITURA	CODICE	DIMENSIONI	FINITURA
<b>138/P</b>	H45,8 L36,4 Sp1,0 cm	Bianco Liscio	<b>145P</b>	H65,7 L36,4 Sp1,0 cm	Bianco Liscio
					

# Quadrante

- COLLECTION -

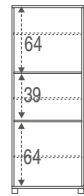

- LISTINO TECNICO -

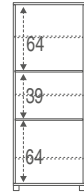
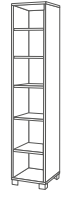
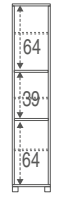
CODICE	DIMENSIONI	INTERNO / ACCESSORI	RIPIANI DI SERIE	VOLUME PZ x PALLET	PESO L PESO N
<b>7CM51</b> 017 	<b>H183 L70 P41</b> cm struttura sp. 18 mm		<b>H174 L66 P37</b> cm 3 cod. <b>151/P</b> 2 tramezze orizzontali fisse	0,541 mc <b>H179 L72 P42</b> cm 3	59,4 kg 58,0 kg
<b>7CM54</b> 017 	<b>H183 L70 P41</b> cm struttura sp. 18 mm		<b>H174 L66 P37</b> cm 3 cod. <b>151/P</b> 2 tramezze orizzontali fisse	0,541 mc <b>H179 L72 P42</b> cm 3	61,4 kg 60,0 kg
<b>7CM61</b> 017 	<b>H183 L37 P41</b> cm struttura sp. 18 mm		<b>H174 L33 P37</b> cm 3 cod. <b>152/P</b> 2 tramezze orizzontali fisse	0,293 mc <b>H179 L39 P42</b> cm 6	39,7 kg 38,7 kg

E ESSENZA

Configurazione Maniglie e piedini cromo satinati.  
Standard

FINITURE STRUTTURA

FINITURE FRONTALI

E - Bianco Fiammato  
- Olmo Chiaro

E - Bianco Fiammato  
- Olmo Chiaro

E - Bianco Fiammato  
- Olmo Chiaro

E - Bianco Fiammato  
- Olmo Chiaro

RIPIANI e ACCESSORI

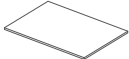
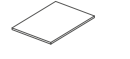
CODICE	DIMENSIONI	FINITURA	CODICE	DIMENSIONI	FINITURA
<b>151/P</b> 	<b>H65,8 L37,4 Sp1,8</b> cm	Bianco Fiammato Olmo Chiaro	<b>152/P</b> 	<b>H32,8 L37,4 Sp1,8</b> cm	Bianco Fiammato Olmo Chiaro

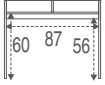
CODICE	DIMENSIONI	INTERNO / ACCESSORI	RIPIANI DI SERIE	VOLUME PZ x PALLET	PESO L PESO N
<b>718k</b> <b>kit</b>	<b>H76 L91 P55</b> cm struttura sp. <b>18 mm</b>	 <b>guide a rullo</b> cassetto <b>H9 L37 P28</b> cm	1 tramezza orizzontale fissa 1 tramezza verticale fissa	0,062 mc <b>H95 L59 P11</b> cm 10	29,2 kg 28,0 kg

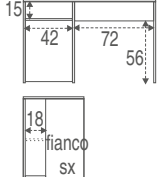
<b>719k</b> <b>kit</b>	<b>H76 L120 P55</b> cm struttura sp. <b>18 mm</b>	 <b>guide a rullo</b> cassetto <b>H11 L37 P28</b> cm	1 cod. <b>147/P</b> 2 tramezze orizzontali fisse	0,142 mc <b>H153 L62 P15</b> cm 8	46,5 kg 45,0 kg
------------------------	--	--	---	---	--------------------

<b>728k</b> <b>kit</b>	<b>H73 L120 P73</b> cm struttura sp. <b>18 mm</b>			0,088 mc <b>H153 L82 P7</b> cm 16	33,0 kg 31,6 kg
------------------------	--	---	--	---	--------------------

<b>729k</b> <b>kit</b>	<b>H73 L150 P73</b> cm struttura sp. <b>18 mm</b>			0,088 mc <b>H153 L82 P7</b> cm 16	38,0 kg 36,6 kg
------------------------	--	---	--	---	--------------------

<b>733</b>	<b>H70 L50 P41</b> cm struttura sp. <b>18 mm</b>	 <b>guide a rullo</b> cassetto <b>H16 L41 P34</b> cm	1 cassetto con chiave	0,139 mc <b>H65 L51 P42</b> cm 12	25,0 kg 24,6 kg
------------	---	--	-----------------------	---	--------------------

E ESSENZA

Configurazione Maniglie e piedini cromo satinati.  
Standard

FINITURE STRUTTURA

FINITURE FRONTALI

**E** - Bianco Fiammato  
- Olmo Chiaro

**E** - Bianco Fiammato  
- Olmo Chiaro

**E** - Bianco Fiammato  
- Olmo Chiaro

**E** - Bianco Fiammato  
- Olmo Chiaro

**E** - Bianco Fiammato  
- Olmo Chiaro









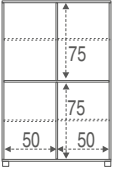

**E** - Bianco Fiammato  
- Olmo Chiaro

**E** - Bianco Fiammato  
- Olmo Chiaro

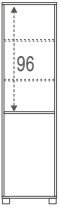
**E** - Bianco Fiammato  
- Olmo Chiaro

RIPIANI e ACCESSORI

CODICE	DIMENSIONI	FINITURA	CODICE	DIMENSIONI	FINITURA
<b>147/P</b>	<b>H42,5 L18,3 Sp1,6</b> cm	Bianco Fiammato Olmo Chiaro			
			<b>Ca0576</b> <b>4 pz</b> 2pz con fermo 	<b>H8 L6,5 P3,5</b> cm	Grigio Satinato

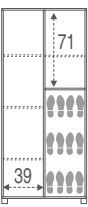
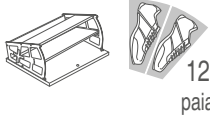
CODICE	DIMENSIONI	INTERNO / ACCESSORI	RIPIANI DI SERIE	VOLUME PZ x PALLET	PESO L PESO N
<b>734k</b> 	<b>H162 L107 P41</b> cm struttura sp. 		<b>H153 L102 P37</b> cm 4 cod. <b>136/P</b> 1 tramezza orizzontale fissa 2 tramezze verticali fisse	STRUTTURA 0,104 mc <b>H157 L44 P15</b> cm 16 FRONTALI 0,053 mc <b>H82 L54 P12</b> cm 20	55,6 kg 53,2 kg
<b>735</b>	<b>H183 L50 P41</b> cm struttura sp. 		<b>H174 L46 P37</b> cm 2 cod. <b>138/P</b> guide a rullo cassetto <b>H16 L41 P34</b> cm 1 tramezza orizzontale fissa	0,386 mc <b>H180 L51 P42</b> cm 6	58,4 kg 57,6 kg
<b>741</b>	<b>H124 L63 P34</b> cm struttura sp. 		<b>H115 L58 P30</b> cm 2 cod. <b>104/P</b> guide in plastica cassetto <b>H16 L55 P27</b> cm	0,271 mc <b>H121 L64 P35</b> cm 6	30,0 kg 29,5 kg
<b>7418</b>	<b>H190 L83 P29</b> cm struttura sp. 		<b>H181 L78 P25</b> cm 8 cod. <b>119/P</b> 1 tramezza verticale fissa	0,469 mc <b>H186 L84 P30</b> cm 4	53,3 kg 52,4 kg
<b>7424</b>	<b>H190 L83 P29</b> cm struttura sp. 		<b>H181 L78 P25</b> cm 4 cod. <b>119/P</b> 1 tramezza orizzontale fissa 1 tramezza verticale fissa  12 paia	0,469 mc <b>H186 L84 P30</b> cm 4	55,7 kg 54,9 kg

RIPIANI e ACCESSORI

CODICE	DIMENSIONI	FINITURA	CODICE	DIMENSIONI	FINITURA
<b>104/P</b>	<b>H58,4 L28,5 Sp1,0</b> cm	Bianco Liscio	<b>119/P</b>	<b>H38,6 L24,5 Sp1,0</b> cm	Bianco Liscio

E ESSENZA

L LACCATO

S SPECCHIO

Apertura mobile anta singola a dx. Maniglie e piedini cromo satinati.  
Configurazione Standard Maniglie e piedini bruniti se struttura con finitura Ossido Nero, Titanio.  
Maniglie e piedini bruniti se struttura e frontali con finitura Cemento.

FINITURE STRUTTURA

- Bianco Fiammato  
- Cemento  
**E** - Noce Stelvio  
- Olmo Chiaro  
- Ossido Nero

- Bianco Fiammato  
- Cemento  
**E** - Noce Stelvio  
- Olmo Chiaro  
- Ossido Nero

- Bianco Fiammato  
- Cemento  
**E** - Olmo Chiaro  
- Ossido Nero  
- Titanio

- Bianco Fiammato  
- Cemento  
**E** - Olmo Chiaro  
- Ossido Nero  
- Titanio

- Bianco Fiammato  
**E** - Cemento  
- Olmo Chiaro

- Bianco Fiammato  
**E** - Cemento  
- Olmo Chiaro

- Bianco Fiammato  
**E** - Cemento  
- Olmo Chiaro

FINITURE FRONTALI

- Bianco Fiammato  
- Cemento  
**E** - Noce Stelvio  
- Olmo Chiaro  
- Ossido Bianco

**L** - Bianco Lucido

- Bianco Fiammato - Olmo Chiaro  
**E** - Cemento - Ossido Bianco  
- Noce Stelvio - Quercia Bianco

**L** - Bianco Lucido











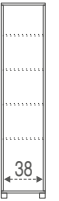

- Bianco Fiammato  
**E** - Olmo Chiaro  
- Ossido Bianco

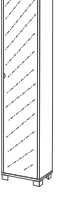
**S** - Specchio Naturale

**S** - Specchio Naturale

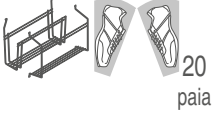
RIPIANI e ACCESSORI

CODICE	DIMENSIONI	FINITURA	CODICE	DIMENSIONI	FINITURA
<b>136/P</b>	<b>H50,3 L36,4 Sp1,0</b> cm	Bianco Liscio	<b>138/P</b>	<b>H45,8 L36,4 Sp1,0</b> cm	Bianco Liscio

CODICE	DIMENSIONI	INTERNO / ACCESSORI	RIPIANI DI SERIE	VOLUME PZ x PALLET	PESO L PESO N
<b>744</b> 	<b>H190 L43 P29</b> cm struttura sp. <b>18 mm</b>		<b>H181 L38 P25</b> cm 4 cod. <b>119/P</b>	0,246 mc <b>H186 L44 P30</b> cm 6	30,8 kg 30,3 kg
<b>744k</b> <b>kit</b> 	<b>H190 L43 P29</b> cm struttura sp. <b>18 mm</b>		<b>H181 L38 P25</b> cm 4 cod. <b>119/P</b>	0,108 mc <b>H188 L48 P12</b> cm 20	31,8 kg 30,3 kg
<b>744sp</b> 	<b>H190 L43 P29</b> cm struttura sp. <b>18 mm</b>		<b>H181 L38 P25</b> cm 4 cod. <b>119/P</b>	0,251 mc <b>H186 L45 P30</b> cm 6	35,0 kg 34,2 kg
<b>744spk</b> <b>kit</b> 	<b>H190 L43 P29</b> cm struttura sp. <b>18 mm</b>		<b>H181 L38 P25</b> cm 4 cod. <b>119/P</b>	0,108 mc <b>H188 L48 P12</b> cm 20	36,7 kg 34,2 kg
<b>745</b> 	<b>H190 L43 P29</b> cm struttura sp. <b>18 mm</b>		<b>H181 L38 P25</b> cm  20 paia	0,246 mc <b>H186 L44 P30</b> cm 6	32,4 kg 31,6 kg
<b>745sp</b> 	<b>H190 L43 P29</b> cm struttura sp. <b>18 mm</b>		<b>H181 L38 P25</b> cm  20 paia	0,251 m <b>H186 L45 P30</b> cm 6	36,3 kg 35,5 kg

RIPIANI e ACCESSORI

CODICE	DIMENSIONI	FINITURA
<b>119/P</b> 	<b>H38,6 L24,5 Sp1,0</b> cm	Bianco Liscio

E ESSENZA

S SPECCHIO

Apertura mobile anta singola a dx. Maniglie e piedini cromo satinati.  
Configurazione Piedini bruniti se struttura con finitura Ossido Nero, Titanio.  
Standard Piedini bruniti se struttura e frontali con finitura Cemento.

FINITURE STRUTTURA

FINITURE FRONTALI

- E**
- Bianco Fiammato
  - Cemento
  - Noce Stelvio
  - Olmo Chiaro
  - Ossido Nero
  - Titanio

- E**
- Bianco Fiammato
  - Cemento
  - Noce Stelvio
  - Olmo Chiaro
  - Ossido Bianco
  - Quercia Bianco

- E**
- Bianco Fiammato
  - Cemento
  - Noce Stelvio
  - Olmo Chiaro
  - Ossido Nero
  - Titanio

- E**
- Bianco Fiammato
  - Cemento
  - Noce Stelvio
  - Olmo Chiaro
  - Ossido Bianco
  - Quercia Bianco

- E**
- Bianco Fiammato
  - Cemento
  - Noce Stelvio
  - Olmo Chiaro
  - Ossido Nero
  - Titanio

- S** - Specchio Naturale

- E**
- Bianco Fiammato
  - Cemento
  - Noce Stelvio
  - Olmo Chiaro
  - Ossido Nero
  - Titanio

- S** - Specchio Naturale









- E**
- Bianco Fiammato
  - Cemento
  - Noce Stelvio
  - Olmo Chiaro
  - Ossido Nero
  - Titanio

- E**
- Bianco Fiammato
  - Cemento
  - Noce Stelvio
  - Olmo Chiaro
  - Ossido Bianco
  - Quercia Bianco

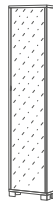
- E**
- Bianco Fiammato
  - Cemento
  - Noce Stelvio
  - Olmo Chiaro
  - Ossido Nero
  - Titanio

- S** - Specchio Naturale

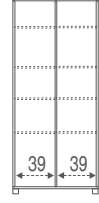
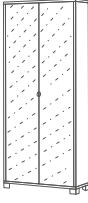
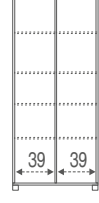
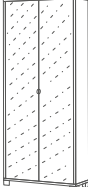
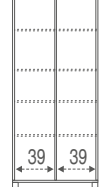

CODICE	DIMENSIONI	INTERNO / ACCESSORI	RIPIANI DI SERIE	VOLUME PZ x PALLET	PESO L PESO N
<b>746</b> 	<b>H190 L43 P18</b> cm struttura sp. <b>18 mm</b>		<b>H181 L38 P14</b> cm  10 paia	0,168 mc <b>H187 L45 P20</b> cm 8	25,0 kg 24,1 kg
<b>746sp</b> 	<b>H190 L43 P18</b> cm struttura sp. <b>18 mm</b>		<b>H181 L38 P14</b> cm  10 paia	0,168 mc <b>H187 L45 P20</b> cm 8	29,2 kg 28,3 kg
<b>747</b> 	<b>H190 L83 P29</b> cm struttura sp. <b>18 mm</b>	 39 39	<b>H181 L80 P25</b> cm 8 cod. <b>119/P</b> 1 tramezza verticale fissa	0,469 mc <b>H186 L84 P30</b> cm 4	52,0 kg 51,0 kg
<b>747k</b> <b>kit</b> 	<b>H190 L83 P29</b> cm struttura sp. <b>18 mm</b>	 39 39	<b>H181 L80 P25</b> cm 8 cod. <b>119/P</b> 1 tramezza verticale fissa	0,158 mc <b>H194 L48 P17</b> cm 8	53,3 kg 51,0 kg
<b>747sp</b> 	<b>H190 L83 P29</b> cm struttura sp. <b>18 mm</b>	 39 39	<b>H181 L80 P25</b> cm 8 cod. <b>119/P</b> 1 tramezza verticale fissa	0,474 mc <b>H186 L85 P30</b> cm 4	59,7 kg 58,3 kg
<b>747spk</b> <b>kit</b> 	<b>H190 L83 P29</b> cm struttura sp. <b>18 mm</b>	 39 39	<b>H181 L80 P25</b> cm 8 cod. <b>119/P</b> 1 tramezza verticale fissa	0,158 mc <b>H194 L48 P17</b> cm 8	60,5 kg 58,3 kg

RIPIANI e ACCESSORI

CODICE      DIMENSIONI      FINITURA

**119/P**

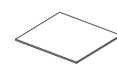

**H38,6 L24,5 Sp1,0** cm      Bianco Liscio

**E ESSENZA**

**L LACCATO**

**S SPECCHIO**

**Configurazione Standard** Apertura mobile anta singola a dx. Maniglie e piedini cromo satinati. Maniglie e piedini bruniti se struttura con finitura Ossido Nero, Titanio. Maniglie e piedini bruniti se struttura e frontali con finitura Cemento.

FINITURE STRUTTURA

- Bianco Fiammato
- Cemento
- E** - Olmo Chiaro
- Ossido Nero
- Titanio

**L** - Bianco Lucido

- Bianco Fiammato
- Cemento
- E** - Olmo Chiaro
- Ossido Nero
- Titanio

**L** - Bianco Lucido

- Bianco Fiammato
- Cemento
- E** - Noce Stelvio
- Olmo Chiaro
- Ossido Nero
- Titanio

- Bianco Fiammato
- Cemento
- E** - Noce Stelvio
- Olmo Chiaro
- Ossido Nero
- Titanio

- Bianco Fiammato
- Cemento
- E** - Noce Stelvio
- Olmo Chiaro
- Ossido Nero
- Titanio

- Bianco Fiammato
- Cemento
- E** - Noce Stelvio
- Olmo Chiaro
- Ossido Nero
- Titanio

FINITURE FRONTALI

- Bianco Fiammato
- Cemento
- E** - Noce Stelvio
- Olmo Chiaro

- Bianco Fiammato
- Cemento
- E** - Noce Stelvio
- Olmo Chiaro

**S** - Specchio Naturale







**S** - Specchio Naturale

- Bianco Fiammato
- Cemento
- E** - Noce Stelvio
- Olmo Chiaro
- Ossido Bianco
- Quercia Bianco

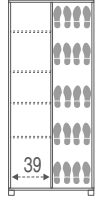
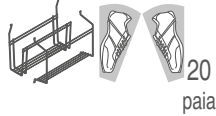
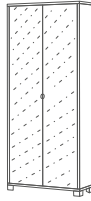
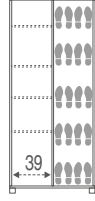
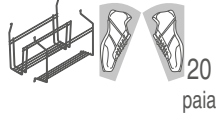
- Bianco Fiammato
- Cemento
- E** - Noce Stelvio
- Olmo Chiaro
- Ossido Bianco
- Quercia Bianco

**S** - Specchio Naturale

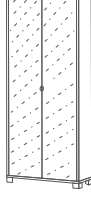
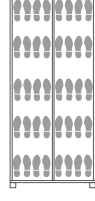
**S** - Specchio Naturale

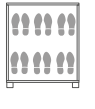
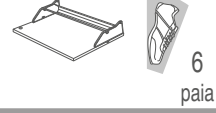
CODICE	DIMENSIONI	INTERNO / ACCESSORI	RIPIANI DI SERIE	VOLUME PZ x PALLET	PESO L PESO N
<b>748</b> 	<b>H190 L83 P29</b> cm struttura sp. 18 mm		<b>H181 L80 P25</b> cm 4 cod. <b>119/P</b> 1 tramezza verticale fissa  20 paia	0,469 mc <b>H186 L84 P30</b> cm 4	54,2 kg 52,6 kg
<b>748sp</b> 	<b>H190 L83 P29</b> cm struttura sp. 18 mm		<b>H181 L80 P25</b> cm 4 cod. <b>119/P</b> 1 tramezza verticale fissa  20 paia	0,474 mc <b>H186 L85 P30</b> cm 4	61,8 kg 60,2 kg
<b>749</b> 	<b>H190 L83 P29</b> cm struttura sp. 18 mm		<b>H181 L80 P25</b> cm 1 tramezza verticale fissa  40 paia	0,469 mc <b>H186 L84 P30</b> cm 4	57,0 kg 56,0 kg
<b>749sp</b> 	<b>H190 L83 P29</b> cm struttura sp. 18 mm		<b>H181 L80 P25</b> cm 1 tramezza verticale fissa  40 paia	0,474 mc <b>H186 L85 P30</b> cm 4	65,2 kg 63,4 kg
<b>752</b> 	<b>H82 L70 P18</b> cm struttura sp. 18 mm		<b>H72 L66 P14</b> cm  6 paia	0,123 mc <b>H80 L73 P21</b> cm 18	17,5 kg 16,9 kg

RIPIANI e ACCESSORI

CODICE      DIMENSIONI      FINITURA

**119/P**

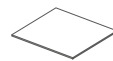

**H38,6 L24,5 Sp1,0** cm      Bianco Liscio

**E ESSENZA**

**L LACCATO**

**S SPECCHIO**

Maniglie e piedini cromo satinati. Maniglie e piedini bruniti se struttura con  
Configurazione Standard finitura Ossido Nero, Titanio. Maniglie e piedini bruniti se struttura e frontali  
con finitura Cemento. Apertura sincronizzata su art. 752

FINITURE STRUTTURA

- Bianco Fiammato  
- Cemento  
**E** - Noce Stelvio  
- Olmo Chiaro  
- Ossido Nero  
- Titanio

FINITURE FRONTALI

- Bianco Fiammato  
- Cemento  
**E** - Noce Stelvio  
- Olmo Chiaro  
- Ossido Bianco  
- Quercia Bianco

- Bianco Fiammato  
- Cemento  
**E** - Noce Stelvio  
- Olmo Chiaro  
- Ossido Nero  
- Titanio

**S** - Specchio Naturale

- Bianco Fiammato  
- Cemento  
**E** - Noce Stelvio  
- Olmo Chiaro  
- Ossido Nero  
- Titanio

- Bianco Fiammato  
- Cemento  
**E** - Noce Stelvio  
- Olmo Chiaro  
- Ossido Bianco  
- Quercia Bianco

- Bianco Fiammato  
- Cemento  
**E** - Noce Stelvio  
- Olmo Chiaro  
- Ossido Nero  
- Titanio







**S** - Specchio Naturale

- Bianco Fiammato - Olmo Chiaro  
**E** - Cemento - Ossido Nero  
- Noce Stelvio - Titanio

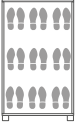
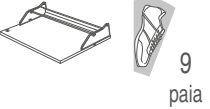
- Bianco Fiammato - Olmo Chiaro  
**E** - Cemento - Ossido Bianco  
- Noce Stelvio - Quercia Bianco

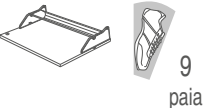
- Bianco Fiammato - Olmo Chiaro  
**E** - Cemento - Ossido Nero  
- Noce Stelvio - Titanio

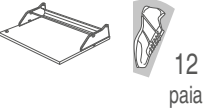
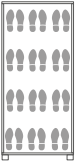
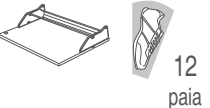
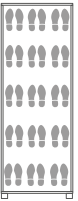
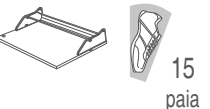
**L** - Bianco Lucido

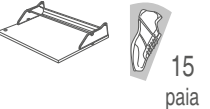
CODICE	DIMENSIONI	INTERNO / ACCESSORI	RIPIANI DI SERIE	VOLUME PZ x PALLET	PESO L PESO N
<b>753</b>	<b>H118 L70 P18 cm</b> struttura sp. 18 mm		<b>H109 L66 P14 cm</b>  9 paia	0,178 mc <b>H116 L73 P21 cm</b> 12	22,5 kg 21,7 kg
<b>753sp</b>	<b>H118 L70 P18 cm</b> struttura sp. 18 mm		<b>H109 L66 P14 cm</b>  9 paia	0,178 mc <b>H116 L73 P21 cm</b> 12	25,5 kg 24,7 kg
<b>754</b>	<b>H154 L70 P18 cm</b> struttura sp. 18 mm		<b>H145 L66 P14 cm</b>  12 paia	0,233 mc <b>H152 L73 P21 cm</b> 6	28,5 kg 27,0 kg
<b>754sp</b>	<b>H154 L70 P18 cm</b> struttura sp. 18 mm		<b>H145 L66 P14 cm</b>  12 paia	0,233 mc <b>H152 L73 P21 cm</b> 6	32,0 kg 31,0 kg
<b>755</b>	<b>H190 L70 P18 cm</b> struttura sp. 18 mm		<b>H181 L66 P14 cm</b>  15 paia	0,288 mc <b>H188 L73 P21 cm</b> 6	32,9 kg 31,4 kg
<b>755sp</b>	<b>H190 L70 P18 cm</b> struttura sp. 18 mm		<b>H181 L66 P14 cm</b>  15 paia	0,288 mc <b>H188 L73 P21 cm</b> 6	39,7 kg 38,2 kg

E ESSENZA

L LACCATO

S SPECCHIO

Maniglie e piedini cromo satinati. Maniglie e piedini bruniti se struttura con  
Configurazione Standard finitura Ossido Nero, Titanio. Maniglie e piedini bruniti se struttura e frontali  
con finitura Cemento. Apertura sincronizzata su art. 753, 754, 755

FINITURE STRUTTURA

**E** - Bianco Fiammato  
- Cemento  
- Noce Stelvio

- Olmo Chiaro  
- Ossido Nero  
- Titanio

**E** - Bianco Fiammato  
- Cemento  
- Noce Stelvio

- Olmo Chiaro  
- Ossido Nero  
- Titanio

**E** - Bianco Fiammato  
- Cemento  
- Noce Stelvio  
- Olmo Chiaro  
- Ossido Nero  
- Titanio

**E** - Bianco Fiammato  
- Cemento  
- Noce Stelvio

- Olmo Chiaro  
- Ossido Nero  
- Titanio

**E** - Bianco Fiammato  
- Cemento  
- Noce Stelvio

- Olmo Chiaro  
- Ossido Nero  
- Titanio

**E** - Bianco Fiammato  
- Cemento  
- Noce Stelvio  
- Olmo Chiaro  
- Ossido Nero  
- Titanio

**E** - Bianco Fiammato  
- Cemento

- Noce Stelvio  
- Olmo Chiaro  
- Ossido Nero  
- Titanio

**E** - Bianco Fiammato  
- Cemento

- Noce Stelvio  
- Olmo Chiaro  
- Ossido Nero  
- Titanio

**L** - Bianco Lucido

**L** - Bianco Lucido

**E** - Bianco Fiammato  
- Cemento  
- Noce Stelvio

- Olmo Chiaro  
- Ossido Nero  
- Titanio

**L** - Bianco Lucido

FINITURE FRONTALI

**E** - Bianco Fiammato  
- Cemento  
- Noce Stelvio

- Olmo Chiaro  
- Ossido Bianco  
- Quercia Bianco

**L** - Bianco Lucido

**S** - Specchio Naturale

**E** - Bianco Fiammato  
- Cemento  
- Noce Stelvio

- Olmo Chiaro  
- Ossido Bianco  
- Quercia Bianco

**L** - Bianco Lucido

**S** - Specchio Naturale

**E** - Bianco Fiammato  
- Cemento

- Noce Stelvio  
- Olmo Chiaro  
- Ossido Bianco  
- Quercia Bianco

**L** - Bianco Lucido













**E** - Bianco Fiammato  
- Cemento

- Noce Stelvio  
- Olmo Chiaro  
- Ossido Bianco  
- Quercia Bianco

**L** - Bianco Lucido

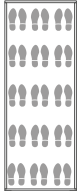
**S** - Specchio Naturale

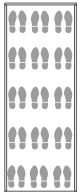
**S** - Specchio Naturale

CODICE	DIMENSIONI	INTERNO / ACCESSORI	RIPIANI DI SERIE	VOLUME PZ x PALLET	PESO L PESO N
<b>763</b>	<b>H118 L70 P29 cm</b> struttura sp. <b>18 mm</b>		<b>H109 L66 P25 cm</b>  18 paia	0,271 mc <b>H116 L73 P32 cm</b> 8	32,5 kg 31,2 kg
<b>763sp</b>	<b>H118 L70 P29 cm</b> struttura sp. <b>18 mm</b>		<b>H109 L66 P25 cm</b>  18 paia	0,271 mc <b>H116 L73 P32 cm</b> 8	35,5 kg 34,2 kg
<b>764</b>	<b>H154 L70 P29 cm</b> struttura sp. <b>18 mm</b>		<b>H145 L66 P25 cm</b>  24 paia	0,355 mc <b>H152 L73 P32 cm</b> 4	42,7 kg 41,3 kg
<b>764sp</b>	<b>H154 L70 P29 cm</b> struttura sp. <b>18 mm</b>		<b>H145 L66 P25 cm</b>  24 paia	0,355 mc <b>H152 L73 P32 cm</b> 4	46,7 kg 45,3 kg
<b>765</b>	<b>H190 L70 P29 cm</b> struttura sp. <b>18 mm</b>		<b>H181 L66 P25 cm</b>  30 paia	0,439 mc <b>H188 L73 P32 cm</b> 4	51,5 kg 49,8 kg
<b>765sp</b>	<b>H190 L70 P29 cm</b> struttura sp. <b>18 mm</b>		<b>H181 L66 P25 cm</b>  30 paia	0,439 mc <b>H188 L73 P32 cm</b> 4	58,8 kg 56,5 kg

**E ESSENZA**

**L LACCATO**

**S SPECCHIO**

**Configurazione Standard**

Maniglie e piedini cromo satinati. Cromo lucidi se struttura con finitura Bianco Lucido.  
Maniglie e piedini bruniti se struttura con finitura Ossido Nero, Titanio. Maniglie e piedini bruniti se struttura e frontali con finitura Cemento.

**FINITURE STRUTTURA**

**E** - Bianco Fiammato - Noce Stelvio - Ossido Nero  
- Cemento - Olmo Chiaro - Titanio

**E** - Bianco Fiammato - Noce Stelvio - Ossido Nero  
- Cemento - Olmo Chiaro - Titanio

**L** - Bianco Lucido

**L** - Bianco Lucido

- Bianco Fiammato  
- Cemento

**E** - Olmo Chiaro  
- Ossido Nero  
- Titanio

**L** - Bianco Lucido

**E** - Bianco Fiammato - Noce Stelvio - Ossido Nero  
- Cemento - Olmo Chiaro - Titanio

**E** - Bianco Fiammato - Noce Stelvio - Ossido Nero  
- Cemento - Olmo Chiaro - Titanio

**L** - Bianco Lucido

**L** - Bianco Lucido

- Bianco Fiammato - Olmo Chiaro  
**E** - Cemento - Ossido Nero  
- Noce Stelvio - Titanio

**L** - Bianco Lucido

- Bianco Fiammato - Olmo Chiaro  
**E** - Cemento - Ossido Nero  
- Noce Stelvio - Titanio

- Bianco Fiammato - Olmo Chiaro  
**E** - Cemento - Ossido Nero  
- Noce Stelvio - Titanio

- Bianco Fiammato  
- Cemento  
**E** - Noce Stelvio  
- Olmo Chiaro  
- Ossido Nero  
- Titanio

**FINITURE FRONTALI**

**E** - Bianco Fiammato - Noce Stelvio - Ossido Bianco  
- Cemento - Olmo Chiaro - Quercia Bianco

**L** - Bianco Lucido

**E** - Bianco Fiammato - Noce Stelvio - Ossido Bianco  
- Cemento - Olmo Chiaro - Quercia Bianco

**L** - Bianco Lucido

**S** - Specchio Naturale

**S** - Specchio Naturale

**E** - Bianco Fiammato - Noce Stelvio - Ossido Bianco  
- Cemento - Olmo Chiaro - Quercia Bianco

**L** - Bianco Lucido

**E** - Bianco Fiammato - Noce Stelvio - Ossido Bianco  
- Cemento - Olmo Chiaro - Quercia Bianco

**L** - Bianco Lucido

**S** - Specchio Naturale

**S** - Specchio Naturale

- Bianco Fiammato - Olmo Chiaro  
**E** - Cemento - Ossido Bianco  
- Noce Stelvio - Quercia Bianco

**L** - Bianco Lucido

**S** - Specchio Naturale

CODICE	DIMENSIONI	INTERNO / ACCESSORI	RIPIANI DI SERIE	VOLUME PZ x PALLET	PESO L PESO N
<b>768</b>	<b>H183 L63 P34</b> cm struttura sp. <b>18 mm</b>		<b>H174 L58 P30</b> cm 3 cod. <b>104/P</b> 1 tramezza orizzontale fissa	0,401 mc <b>H179 L64 P35</b> cm 3	42,5 kg 41,6 kg
<b>768ps</b>	<b>H183 L63 P34</b> cm struttura sp. <b>18 mm</b>		<b>H174 L58 P30</b> cm 5 cod. <b>101/P - 102/P</b> 1 tramezza orizzontale fissa 1 tramezza verticale fissa	0,401 mc <b>H179 L64 P35</b> cm 3	42,5 kg 41,6 kg
<b>771</b>	<b>H124 L50 P41</b> cm struttura sp. <b>18 mm</b>		<b>H115 L46 P37</b> cm guide a rullo cassetto <b>H16 L41 P34</b> cm	0,259 mc <b>H121 L51 P42</b> cm 6	47,0 kg 46,2 kg
<b>772</b>	<b>H112 L70 P41</b> cm struttura sp. <b>18 mm</b>		<b>H102 L66 P37</b> cm guide a rullo cassetto superiore <b>H22 L27 P34</b> cm cassetto inferiore <b>H16 L61 P34</b> cm 1 tramezza orizzontale fissa 1 tramezza verticale fissa	0,322 mc <b>H108 L71 P42</b> cm 6	46,5 kg 45,8 kg
<b>772k</b> <b>kit</b>	<b>H112 L70 P41</b> cm struttura sp. <b>18 mm</b>		<b>H102 L66 P37</b> cm guide a rullo cassetto superiore <b>H22 L27 P34</b> cm cassetto inferiore <b>H16 L61 P34</b> cm 1 tramezza orizzontale fissa 1 tramezza verticale fissa	0,098 mc <b>H112 L44 P20</b> cm 12	48,4 kg 45,8 kg
<b>773</b>	<b>H179 L77 P34</b> cm struttura sp. <b>16 mm</b>		<b>H171 L71 P30</b> cm guide in plastica cassetto <b>H8 L39 P27</b> cm 1 tramezza orizzontale fissa 1 tramezza verticale fissa	0,478 mc <b>H175 L78 P35</b> cm 3	48,0 kg 47,1 kg

RIPIANI e ACCESSORI

CODICE	DIMENSIONI	FINITURA	CODICE	DIMENSIONI	FINITURA
<b>101/P</b>	<b>H27,6 L28,5 Sp1,0</b> cm	Bianco Liscio	<b>102/P</b>	<b>H29,1 L28,5 Sp1,0</b> cm	Bianco Liscio

E ESSENZA

L LACCATO

Maniglie e piedini cromo satinati.  
Configurazione Standard Maniglie e piedini bruniti se struttura con finitura Ossido Nero, Titanio.  
Maniglie e piedini bruniti se struttura e frontali con finitura Cemento.

FINITURE STRUTTURA

FINITURE FRONTALI

- Bianco Fiammato  
E - Cemento  
- Olmo Chiaro

- Bianco Fiammato  
E - Olmo Chiaro  
- Ossido Bianco

- Bianco Fiammato  
E - Cemento  
- Olmo Chiaro

- Bianco Fiammato  
E - Olmo Chiaro  
- Ossido Bianco

- Bianco Fiammato  
E - Cemento  
- Noce Stelvio  
- Olmo Chiaro  
- Ossido Nero  
- Titanio

- Bianco Fiammato  
E - Cemento  
- Noce Stelvio  
- Olmo Chiaro  
- Ossido Bianco  
- Quercia Bianco

- Bianco Fiammato  
E - Cemento  
- Noce Stelvio  
- Olmo Chiaro  
- Ossido Nero  
- Titanio

L - Bianco Lucido

- Bianco Fiammato  
E - Cemento  
- Noce Stelvio  
- Olmo Chiaro  
- Ossido Nero  
- Titanio

- Bianco Fiammato  
E - Cemento  
- Noce Stelvio  
- Olmo Chiaro  
- Ossido Bianco  
- Quercia Bianco

- Bianco Fiammato  
E - Cemento  
- Noce Stelvio  
- Olmo Chiaro  
- Ossido Nero  
- Titanio

L - Bianco Lucido

- Bianco Fiammato  
E - Cemento  
- Noce Stelvio  
- Olmo Chiaro  
- Ossido Nero  
- Titanio







- Bianco Fiammato  
E - Cemento  
- Noce Stelvio  
- Olmo Chiaro  
- Ossido Bianco  
- Quercia Bianco

E - Bianco Fiammato  
- Olmo Chiaro

E - Bianco Fiammato  
- Olmo Chiaro

RIPIANI e ACCESSORI

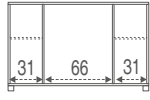
CODICE	DIMENSIONI	FINITURA	CODICE	DIMENSIONI	FINITURA
<b>103/P</b>	<b>H42,3 L28,5 Sp1,0</b> cm	Bianco Liscio	<b>104/P</b>	<b>H58,4 L28,5 Sp1,0</b> cm	Bianco Liscio

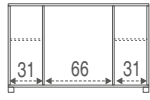
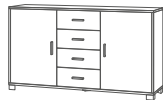
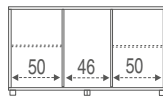
CODICE	DIMENSIONI	INTERNO / ACCESSORI	RIPIANI DI SERIE	VOLUME PZ x PALLET	PESO L PESO N
<b>774</b> 	<b>H112 L70 P41</b> cm struttura sp. 18 mm		<b>H102 L66 P37</b> cm guide a rullo cassetto <b>H22 L61 P34</b> cm	0,322 mc <b>H108 L71 P42</b> cm 6	39,5 kg 38,8 kg
<b>774k</b> <b>kit</b> 	<b>H112 L70 P41</b> cm struttura sp. 18 mm		<b>H102 L66 P37</b> cm guide a rullo cassetto <b>H22 L61 P34</b> cm	0,098 mc <b>H112 L44 P20</b> cm 12	40,4 kg 38,8 kg
<b>775</b> 	<b>H86 L136 P41</b> cm struttura sp. 18 mm	 31 66 31	<b>H76 L128 P37</b> cm guide a rullo cassetto <b>H16 L61 P34</b> cm	2 cod. <b>133/P</b> 2 tramezze verticali fisse	0,487 mc <b>H82 L138 P43</b> cm 5
<b>775k</b> <b>kit</b> 	<b>H86 L136 P41</b> cm struttura sp. 18 mm	 31 66 31	<b>H76 L128 P37</b> cm guide a rullo cassetto <b>H16 L61 P34</b> cm	2 cod. <b>133/P</b> 2 tramezze verticali fisse	0,126 mc <b>H161 L46 P17</b> cm 14
<b>779</b> 	<b>H86 L153 P41</b> cm struttura sp. 18 mm	 50 46 50	<b>H76 L145 P37</b> cm guide a rullo cassetto <b>H16 L41 P34</b> cm	2 cod. <b>137/P</b> 2 tramezze verticali fisse	0,543 mc <b>H82 L154 P43</b> cm 3

RIPIANI e ACCESSORI

CODICE	DIMENSIONI	FINITURA
<b>133/P</b> 	<b>H31,0 L36,4 Sp1,0</b> cm	Bianco Liscio

CODICE	DIMENSIONI	FINITURA
<b>137/P</b> 	<b>H49,6 L36,4 Sp1,0</b> cm	Bianco Liscio

E ESSENZA

L LACCATO

Maniglie e piedini cromo satinati.  
Configurazione Maniglie e piedini bruniti se struttura con finitura Ossido Nero, Titanio.  
Standard Maniglie e piedini bruniti se struttura e frontali con finitura Cemento.

FINITURE STRUTTURA

**E** - Bianco Fiammato - Olmo Chiaro  
- Cemento - Ossido Nero  
- Noce Stelvio - Titanio

**E** - Bianco Fiammato - Olmo Chiaro  
- Cemento - Ossido Nero  
- Noce Stelvio - Titanio

**E** - Bianco Fiammato  
- Cemento  
- Noce Stelvio  
- Olmo Chiaro  
- Ossido Nero  
- Titanio

**E** - Bianco Fiammato - Olmo Chiaro  
- Cemento - Ossido Nero  
- Noce Stelvio - Titanio

**E** - Bianco Fiammato - Olmo Chiaro  
- Cemento - Ossido Nero  
- Noce Stelvio - Titanio

**E** - Bianco Fiammato  
- Cemento  
- Noce Stelvio  
- Olmo Chiaro  
- Ossido Nero  
- Titanio

**E** - Bianco Fiammato - Olmo Chiaro  
- Cemento - Ossido Nero  
- Noce Stelvio - Titanio

**E** - Bianco Fiammato - Olmo Chiaro  
- Cemento - Ossido Nero  
- Noce Stelvio - Titanio

FINITURE FRONTALI

**E** - Bianco Fiammato - Olmo Chiaro  
- Cemento - Ossido Bianco  
- Noce Stelvio - Quercia Bianco

**L** - Bianco Lucido

**E** - Bianco Fiammato  
- Cemento  
- Noce Stelvio  
- Olmo Chiaro  
- Ossido Bianco  
- Quercia Bianco

**E** - Bianco Fiammato - Olmo Chiaro  
- Cemento - Ossido Bianco  
- Noce Stelvio - Quercia Bianco

**L** - Bianco Lucido







**E** - Bianco Fiammato  
- Cemento  
- Noce Stelvio  
- Olmo Chiaro  
- Ossido Bianco  
- Quercia Bianco

**E** - Bianco Fiammato - Olmo Chiaro  
- Cemento - Ossido Bianco  
- Noce Stelvio - Quercia Bianco

**L** - Bianco Lucido

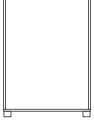
RIPIANI e ACCESSORI

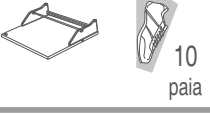
CODICE	DIMENSIONI	FINITURA
<b>Ca0576</b> <b>4 pz</b>  2pz con fermo	<b>H8 L6,5 P3,5</b> cm	Grigio Satinato

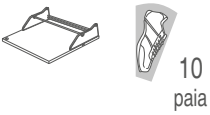
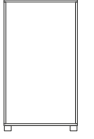
CODICE	DIMENSIONI	INTERNO / ACCESSORI	RIPIANI DI SERIE	VOLUME PZ x PALLET	PESO L PESO N
<b>781</b>	<b>H124 L80 P47 cm</b> struttura sp. <b>18 mm</b>		<b>H115 L76 P44 cm</b> guide a rullo cassetto <b>H16 L81 P39 cm</b>	0,480 mc <b>H121 L81 P49 cm</b> 3	53,1 kg 52,3 kg
<b>782</b>	<b>H82 L70 P29 cm</b> struttura sp. <b>18 mm</b>	  12 paia	<b>H72 L66 P25 cm</b>	0,187 mc <b>H80 L73 P32 cm</b> 12	22,5 kg 21,8 kg
<b>784</b>	<b>H112 L80 P47 cm</b> struttura sp. <b>18 mm</b>		<b>H102 L76 P44 cm</b> guide a rullo cassetto <b>H22 L81 P39 cm</b>	0,429 mc <b>H108 L81 P49 cm</b> 3	49,5 kg 48,8 kg
<b>785</b>	<b>H190 L50 P18 cm</b> struttura sp. <b>18 mm</b>	  10 paia	<b>H181 L46 P14 cm</b>	0,209 mc <b>H188 L53 P21 cm</b> 8	27,5 kg 26,2 kg
<b>785sp</b>	<b>H190 L50 P18 cm</b> struttura sp. <b>18 mm</b>	  10 paia	<b>H181 L46 P14 cm</b>	0,209 mc <b>H188 L53 P21 cm</b> 8	31,2 kg 29,9 kg
<b>786</b>	<b>H124 L70 P41 cm</b> struttura sp. <b>18 mm</b>		<b>H115 L66 P37 cm</b> guide a rullo cassetto <b>H16 L61 P34 cm</b>	0,361 mc <b>H121 L71 P42 cm</b> 6	52,2 kg 51,4 kg

RIPIANI e ACCESSORI

CODICE	DIMENSIONI	FINITURA
<b>Ca0576</b> <b>4 pz</b> 2pz con fermo	<b>H8 L6,5 P3,5 cm</b>	Grigio Satinato

E ESSENZA

L LACCATO

S SPECCHIO

Maniglie e piedini cromo satinati. Cromo lucidi se struttura con finitura Bianco Lucido.  
Configurazione Standard Maniglie e piedini bruniti se struttura con finitura Ossido Nero, Titanio. Maniglie e piedini bruniti se struttura e frontali con finitura Cemento. Apertura sincronizzata su art. 785

FINITURE STRUTTURA

- Bianco Fiammato  
- Cemento  
**E** - Noce Stelvio  
- Olmo Chiaro  
- Ossido Nero  
- Titanio

- Bianco Fiammato  
**E** - Cemento  
- Noce Stelvio

- Bianco Fiammato  
**E** - Cemento  
- Noce Stelvio

- Bianco Fiammato  
- Cemento  
**E** - Noce Stelvio  
- Olmo Chiaro  
- Ossido Nero  
- Titanio

**E** - Bianco Fiammato  
- Cemento

**E** - Bianco Fiammato  
- Cemento

**L** - Bianco Lucido

**L** - Bianco Lucido

**E** - Bianco Fiammato  
- Cemento  
- Noce Stelvio

**L** - Bianco Lucido

- Bianco Fiammato  
- Cemento  
**E** - Noce Stelvio  
- Olmo Chiaro  
- Ossido Nero  
- Titanio

FINITURE FRONTALI

- Bianco Fiammato  
- Cemento  
**E** - Noce Stelvio  
- Olmo Chiaro  
- Ossido Bianco  
- Quercia Bianco

- Bianco Fiammato  
**E** - Cemento  
- Noce Stelvio

**L** - Bianco Lucido

- Bianco Fiammato  
- Cemento  
**E** - Noce Stelvio  
- Olmo Chiaro  
- Ossido Bianco  
- Quercia Bianco

**E** - Bianco Fiammato  
- Cemento

**L** - Bianco Lucido



**E** - Bianco Fiammato  
- Cemento

**L** - Bianco Lucido

**S** - Specchio Naturale

**S** - Specchio Naturale

- Bianco Fiammato  
- Cemento  
**E** - Noce Stelvio  
- Olmo Chiaro  
- Ossido Bianco  
- Quercia Bianco

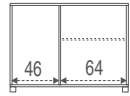
CODICE	DIMENSIONI	INTERNO / ACCESSORI	RIPIANI DI SERIE	VOLUME PZ x PALLET	PESO L PESO N
<b>798k</b> <b>kit</b>	<b>H190 L82 P41</b> cm struttura sp. <b>18 mm</b>		<b>H181 L78 P35</b> cm 8 cod. <b>135/P</b> 1 tramezza verticale fissa	0,160 mc <b>H196 L48 P17</b> cm 14	64,0 kg 62,5 kg
<b>798spk</b> <b>kit</b>	<b>H190 L82 P41</b> cm struttura sp. <b>18 mm</b>		<b>H181 L78 P35</b> cm 8 cod. <b>135/P</b> 1 tramezza verticale fissa	0,160 mc <b>H196 L48 P17</b> cm 14	65,5 kg 64,0 kg
<b>799k</b> <b>kit</b>	<b>H86 L116 P41</b> cm struttura sp. <b>18 mm</b>		<b>H76 L108 P37</b> cm 1 cod. <b>146/P</b> guide a rullo cassetto 1 tramezza verticale fissa	0,110 mc <b>H141 L46 P17</b> cm 14	46,2 kg 44,5 kg

E ESSENZA

S SPECCHIO

Maniglie e piedini cromo satinati.  
Configurazione Standard Maniglie e piedini bruniti se struttura e frontali con finitura Cemento.  
Maniglie e piedini bruniti se struttura e frontali con finitura Cemento.

FINITURE STRUTTURA

FINITURE FRONTALI

- Bianco Fiammato  
**E** - Cemento  
- Olmo Chiaro

- Bianco Fiammato  
**E** - Cemento  
- Olmo Chiaro

- Bianco Fiammato  
**E** - Cemento  
- Olmo Chiaro

**S** - Specchio Naturale

- Bianco Fiammato  
- Cemento  
**E** - Noce Stelvio  
- Olmo Chiaro  
- Ossido Nero  
- Titanio

- Bianco Fiammato  
- Cemento  
**E** - Noce Stelvio  
- Olmo Chiaro  
- Ossido Bianco  
- Quercia Bianco

RIPIANI e ACCESSORI









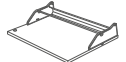

CODICE	DIMENSIONI	FINITURA	CODICE	DIMENSIONI	FINITURA
<b>135/P</b>	<b>H38,2 L34,0 Sp1,0</b> cm	Bianco Liscio	<b>146/P</b>	<b>H64,2 L36,4 Sp1,0</b> cm	Bianco Liscio



*Open Kit*  
- COLLECTION -

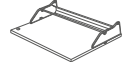

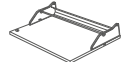
- LISTINO TECNICO -

CODICE	DIMENSIONI	INTERNO / ACCESSORI	RIPIANI DI SERIE	VOLUME PZ x PALLET	PESO L PESO N
<b>Sk553k</b> <b>kit</b>	<b>H117 L63 P18</b> cm struttura sp. 18 mm		<b>H106 L58 P14</b> cm  7 paia	0,055 mc <b>H128 L39 P11</b> cm 20	24,0 kg 22,7 kg
<b>Sk554k</b> <b>kit</b>	<b>H154 L63 P18</b> cm struttura sp. 18 mm		<b>H143 L58 P14</b> cm  10 paia	0,068 mc <b>H159 L39 P11</b> cm 20	29,2 kg 28,0 kg
<b>Sk554spk</b> <b>kit</b>	<b>H154 L63 P18</b> cm struttura sp. 18 mm		<b>H143 L58 P14</b> cm  10 paia	0,068 mc <b>H159 L39 P11</b> cm 20	34,8 kg 33,6 kg
<b>Sk555k</b> <b>kit</b>	<b>H190 L63 P18</b> cm struttura sp. 18 mm		<b>H179 L58 P14</b> cm  12 paia	0,113 mc <b>H197 L44 P13</b> cm 14	34,9 kg 33,4 kg
<b>Sk555spk</b> <b>kit</b>	<b>H190 L63 P18</b> cm struttura sp. 18 mm		<b>H179 L58 P14</b> cm  12 paia	0,113 mc <b>H197 L44 P13</b> cm 14	41,9 kg 40,4 kg
<b>Sk565k</b> <b>kit</b>	<b>H190 L63 P29</b> cm struttura sp. 18 mm		<b>H185 L58 P25</b> cm  25 paia	0,134 mc <b>H195 L43 P16</b> cm 14	45,0 kg 43,5 kg

FINITURE STRUTTURA

- Bianco Fiammato
- Cemento
- E** - Noce Stelvio
- Olmo Chiaro
- Ossido Bianco

FINITURE FRONTALI

- Bianco Fiammato
- Cemento
- E** - Noce Stelvio
- Olmo Chiaro
- Ossido Bianco

- Bianco Fiammato
- Cemento
- E** - Noce Stelvio
- Olmo Chiaro
- Ossido Bianco

- Bianco Fiammato
- Cemento
- E** - Noce Stelvio
- Olmo Chiaro
- Ossido Bianco

- Bianco Fiammato
- Cemento
- E** - Noce Stelvio
- Olmo Chiaro
- Ossido Bianco

- S** - Specchio Naturale

- Bianco Fiammato
- Cemento
- E** - Noce Stelvio
- Olmo Chiaro
- Ossido Bianco

- Bianco Fiammato
- Cemento
- E** - Noce Stelvio
- Olmo Chiaro
- Ossido Bianco

- Bianco Fiammato
- Cemento
- E** - Noce Stelvio
- Olmo Chiaro
- Ossido Bianco

- S** - Specchio Naturale

- Bianco Fiammato
- Cemento
- E** - Noce Stelvio
- Olmo Chiaro
- Ossido Bianco

- Bianco Fiammato
- Cemento
- E** - Noce Stelvio
- Olmo Chiaro
- Ossido Bianco

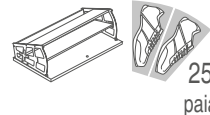
CODICE	DIMENSIONI	INTERNO / ACCESSORI	RIPIANI DI SERIE	VOLUME PZ x PALLET	PESO L PESO N
<b>Sk565spk</b> <b>kit</b>	<b>H190 L63 P29</b> cm struttura sp. <b>18 mm</b>		<b>H185 L58 P25</b> cm  25 paia	0,134 mc <b>H195 L43 P16</b> cm 14	52,0 kg 50,5 kg

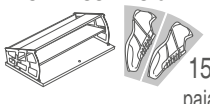
<b>Sk567k</b> <b>kit</b>	<b>H127 L63 P29</b> cm struttura sp. <b>18 mm</b>		<b>H122 L58 P25</b> cm guide a sfera cassetto <b>H8 L55 P23</b> cm  15 paia	0,080 mc <b>H128 L39 P16</b> cm 14	32,0 kg 30,7 kg
--------------------------	--	---	--	--	--------------------

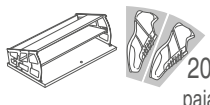
<b>Sk568k</b> <b>kit</b>	<b>H164 L63 P29</b> cm struttura sp. <b>18 mm</b>		<b>H159 L58 P25</b> cm guide a sfera cassetto <b>H8 L55 P23</b> cm  20 paia	0,116 mc <b>H168 L43 P16</b> cm 14	40,7 kg 39,5 kg
--------------------------	--	---	--	--	--------------------

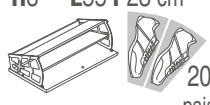
<b>Sk568spk</b> <b>kit</b>	<b>H164 L63 P29</b> cm struttura sp. <b>18 mm</b>		<b>H159 L58 P25</b> cm guide a sfera cassetto <b>H8 L55 P23</b> cm  20 paia	0,116 mc <b>H168 L43 P16</b> cm 14	46,8 kg 45,6 kg
----------------------------	--	--	--	--	--------------------

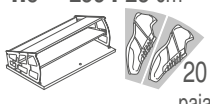
<b>Sk569k</b> <b>kit</b>	<b>H164 L63 P29</b> cm struttura sp. <b>18 mm</b>		<b>H159 L58 P25</b> cm guide a sfera cassetto <b>H8 L55 P23</b> cm  20 paia	0,116 mc <b>H168 L43 P16</b> cm 14	40,7 kg 39,5 kg
--------------------------	--	---	--	--	--------------------

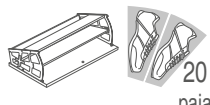
<b>Sk569spk</b> <b>kit</b>	<b>H164 L63 P29</b> cm struttura sp. <b>18 mm</b>		<b>H159 L58 P25</b> cm guide a sfera cassetto <b>H8 L55 P23</b> cm  20 paia	0,116 mc <b>H168 L43 P16</b> cm 14	46,8 kg 45,6 kg
----------------------------	--	---	--	--	--------------------

FINITURE STRUTTURA

- Bianco Fiammato
- Cemento
- E** - Noce Stelvio
- Olmo Chiaro
- Ossido Bianco

FINITURE FRONTALI

- S** - Specchio Naturale

- Bianco Fiammato
- Cemento
- E** - Noce Stelvio
- Olmo Chiaro
- Ossido Bianco

- Bianco Fiammato
- Cemento
- E** - Noce Stelvio
- Olmo Chiaro
- Ossido Bianco

- Bianco Fiammato
- Cemento
- E** - Noce Stelvio
- Olmo Chiaro
- Ossido Bianco

- Bianco Fiammato
- Cemento
- E** - Noce Stelvio
- Olmo Chiaro
- Ossido Bianco

- Bianco Fiammato
- Cemento
- E** - Noce Stelvio
- Olmo Chiaro
- Ossido Bianco

- S** - Specchio Naturale

- Bianco Fiammato
- Cemento
- E** - Noce Stelvio
- Olmo Chiaro
- Ossido Bianco

- Bianco Fiammato
- Cemento
- E** - Noce Stelvio
- Olmo Chiaro
- Ossido Bianco







- Bianco Fiammato
- Cemento
- E** - Noce Stelvio
- Olmo Chiaro
- Ossido Bianco

- S** - Specchio Naturale

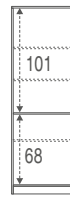
*Glossy*  
- COLLECTION -

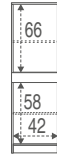

- LISTINO TECNICO -

CODICE	DIMENSIONI	INTERNO / ACCESSORI	RIPIANI DI SERIE	VOLUME PZ x PALLET	PESO L PESO N
<b>168tl</b> 	<b>H183 L62 P34 cm</b> struttura sp. <b>16 mm</b>	 101 68	<b>H171 L58 P30 cm</b> 3 cod. <b>104/P</b> 1 tramezza orizzontale fissa	0,406 mc <b>H184 L63 P35 cm</b> 3	38,0 kg 37,3 kg
<b>222tl</b> 	<b>H80 L46 P34 cm</b> struttura sp. <b>16 mm</b>	 58	<b>H68 L42 P30 cm</b> 1 cod. <b>103/P</b> guide in plastica cassetto <b>H8 L39 P27 cm</b>	0,133 mc <b>H81 L47 P35 cm</b> 15	15,6 kg 15,4 kg
<b>282tl</b> 	<b>H147 L46 P34 cm</b> struttura sp. <b>16 mm</b>	 66 58 42	<b>H136 L42 P30 cm</b> 2 cod. <b>103/P</b> guide in plastica cassetto 1 tramezza orizzontale fissa <b>H8 L39 P27 cm</b>	0,243 mc <b>H148 L47 P35 cm</b> 5	28,1 kg 26,4 kg
<b>313tl</b> 	<b>H183 L31 P34 cm</b> struttura sp. <b>16 mm</b>		<b>H171 L28 P30 cm</b> 3 cod. <b>101/P</b>	0,206 mc <b>H184 L32 P35 cm</b> 6	24,1 kg 23,5 kg

L LACCATO

Configurazione Standard Apertura mobile anta singola a dx. Pomoli cromo lucido.

FINITURE STRUTTURA

FINITURE FRONTALI

L - Bianco Lucido

L - Bianco Lucido

L - Bianco Lucido

L - Bianco Lucido



L - Bianco Lucido

L - Bianco Lucido



L - Bianco Lucido



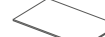

L - Bianco Lucido

RIPIANI e ACCESSORI

CODICE	DIMENSIONI	FINITURA	CODICE	DIMENSIONI	FINITURA
<b>101/P</b> 	<b>H27,6 L28,5 Sp1,0 cm</b>	Bianco Liscio	<b>103/P</b> 	<b>H42,3 L28,5 Sp1,0 cm</b>	Bianco Liscio

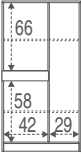
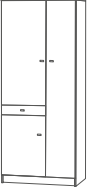
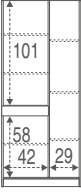
RIPIANI e ACCESSORI

CODICE	DIMENSIONI	FINITURA	CODICE	DIMENSIONI	FINITURA
<b>104/P</b> 	<b>H58,4 L28,5 Sp1,0 cm</b>	Bianco Liscio	<b>130K</b> 	<b>H45,0 L40,0 P28,0 cm</b>	Bianco Liscio

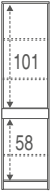
CODICE	DIMENSIONI	INTERNO / ACCESSORI	RIPIANI DI SERIE	VOLUME PZ x PALLET	PESO L PESO N
<b>322ti</b> 	<b>H147 L77 P34 cm</b> struttura sp. <b>16 mm</b>	 <b>H136 L73 P30 cm</b> guide in plastica cassetto <b>H8 L39 P27 cm</b>	<b>4 cod. 102/P - 103/P</b> 1 tramezza orizzontale fissa 1 tramezza verticale fissa	<b>0,404 mc</b> <b>H148 L78 P35 cm</b> 3	<b>39,0 kg</b> <b>38,6 kg</b>
<b>323ti</b> 	<b>H183 L77 P34 cm</b> struttura sp. <b>16 mm</b>	 <b>H168 L73 P30 cm</b> guide in plastica cassetto <b>H8 L39 P27 cm</b>	<b>6 cod. 102/P - 103/P</b> 1 tramezza orizzontale fissa 1 tramezza verticale fissa	<b>0,502 mc</b> <b>H184 L78 P35 cm</b> 3	<b>50,0 kg</b> <b>49,2 kg</b>
<b>342ti</b> 	<b>H80 L77 P34 cm</b> struttura sp. <b>16 mm</b>	 <b>H68 L73 P30 cm</b> guide in plastica cassetto <b>H8 L39 P27 cm</b>	<b>2 cod. 102/P - 103/P</b> 1 tramezza verticale fissa	<b>0,221 mc</b> <b>H81 L78 P35 cm</b> 9	<b>22,7 kg</b> <b>22,3 kg</b>
<b>452ti</b> 	<b>H183 L46 P34 cm</b> struttura sp. <b>16 mm</b>	 <b>H171 L42 P30 cm</b> guide in plastica cassetto <b>H8 L39 P27 cm</b>	<b>3 cod. 103/P</b> 1 tramezza orizzontale fissa	<b>0,303 mc</b> <b>H184 L47 P35 cm</b> 5	<b>31,0 kg</b> <b>30,5 kg</b>

L LACCATO

Configurazione Standard Apertura mobile anta singola a dx. Pomoli cromo lucido.

FINITURE STRUTTURA

FINITURE FRONTALI

L - Bianco Lucido

L - Bianco Lucido

L - Bianco Lucido

L - Bianco Lucido



L - Bianco Lucido

L - Bianco Lucido

L - Bianco Lucido

L - Bianco Lucido

RIPIANI e ACCESSORI

CODICE	DIMENSIONI	FINITURA	CODICE	DIMENSIONI	FINITURA
<b>102/P</b> 	<b>H29,1 L28,5 Sp1,0 cm</b>	Bianco Liscio	<b>103/P</b> 	<b>H42,3 L28,5 Sp1,0 cm</b>	Bianco Liscio

RIPIANI e ACCESSORI

CODICE	DIMENSIONI	FINITURA
<b>130K</b> 	<b>H45,0 L40,0 P28,0 cm</b>	Bianco Liscio

*Mullinsgo*  
- COLLECTION -

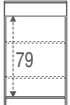
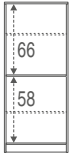
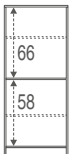
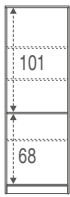
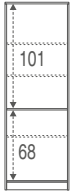
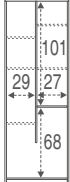

- LISTINO TECNICO -

CODICE	DIMENSIONI	INTERNO / ACCESSORI	RIPIANI DI SERIE	VOLUME PZ x PALLET	PESO L PESO N
<b>141</b>	<b>H105 L62 P34</b> cm struttura sp. <b>16 mm</b>	 <b>H93 L58 P30</b> cm guide in plastica cassetto <b>H10 L55 P27</b> cm	2 cod. <b>104/P</b>	0,227 mc <b>H103 L63 P35</b> cm 9	23,5 kg 23,0 kg
<b>158</b>	<b>H147 L62 P34</b> cm struttura sp. <b>16 mm</b>	 <b>H135 L58 P30</b> cm	2 cod. <b>104/P</b> 1 tramezza orizzontale fissa	0,326 mc <b>H148 L63 P35</b> cm 3	31,0 kg 30,5 kg
<b>158k</b> <b>kit</b>	<b>H147 L62 P34</b> cm struttura sp. <b>16 mm</b>	 <b>H135 L58 P30</b> cm	2 cod. <b>104/P</b> 1 tramezza orizzontale fissa	0,079 mc <b>H188 L38 P11</b> cm 20	32,1 kg 30,5 kg
<b>168</b>	<b>H183 L62 P34</b> cm struttura sp. <b>16 mm</b>	 <b>H171 L58 P30</b> cm	3 cod. <b>104/P</b> 1 tramezza orizzontale fissa	0,406 mc <b>H184 L63 P35</b> cm 3	38,0 kg 37,3 kg
<b>168k</b> <b>kit</b>	<b>H183 L62 P34</b> cm struttura sp. <b>16 mm</b>	 <b>H171 L58 P30</b> cm	3 cod. <b>104/P</b> 1 tramezza orizzontale fissa	0,079 mc <b>H188 L38 P11</b> cm 20	39,3 kg 37,3 kg
<b>168ps</b>	<b>H183 L62 P34</b> cm struttura sp. <b>16 mm</b>	 <b>H171 L58 P30</b> cm	5 cod. <b>101/P - 102/P</b> 1 tramezza orizzontale fissa 1 tramezza verticale fissa	0,406 mc <b>H184 L63 P35</b> cm 3	38,0 kg 37,3 kg

RIPIANI e ACCESSORI

CODICE	DIMENSIONI	FINITURA	CODICE	DIMENSIONI	FINITURA
<b>101/P</b>	<b>H27,6 L28,5 Sp1,0</b> cm	Bianco Liscio	<b>102/P</b>	<b>H29,1 L28,5 Sp1,0</b> cm	Bianco Liscio

E ESSENZA

Configurazione Standard Pomoli in colore bianco se frontali con finitura Bianco Liscio.  
Pomoli cromo satinato se frontali con finitura Olmo Chiaro o Eucalipto.  
Pomoli cromo satinato sui modelli in KIT con qualsiasi finitura.

FINITURE STRUTTURA

- Bianco Liscio  
**E** - Eucalipto  
- Olmo Chiaro

- Bianco Liscio  
**E** - Eucalipto  
- Olmo Chiaro

- Bianco Liscio  
**E** - Eucalipto  
- Olmo Chiaro

- Bianco Liscio  
**E** - Eucalipto  
- Olmo Chiaro

- Bianco Liscio  
**E** - Eucalipto  
- Olmo Chiaro

- Bianco Liscio  
**E** - Eucalipto  
- Olmo Chiaro

FINITURE FRONTALI

- Bianco Liscio  
**E** - Eucalipto  
- Olmo Chiaro

- Bianco Liscio  
**E** - Eucalipto  
- Olmo Chiaro

- Bianco Liscio  
**E** - Eucalipto  
- Olmo Chiaro

- Bianco Liscio  
**E** - Eucalipto  
- Olmo Chiaro

- Bianco Liscio  
**E** - Eucalipto  
- Olmo Chiaro

- Bianco Liscio  
**E** - Eucalipto  
- Olmo Chiaro

RIPIANI e ACCESSORI

CODICE	DIMENSIONI	FINITURA	CODICE	DIMENSIONI	FINITURA
<b>104/P</b>	<b>H58,4 L28,5 Sp1,0</b> cm	Bianco Liscio	<b>130K</b>	<b>H45,0 L40,0 P28,0</b> cm	Bianco Liscio



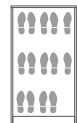
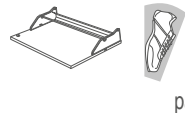

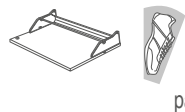
CODICE	DIMENSIONI	INTERNO / ACCESSORI	RIPIANI DI SERIE	VOLUME PZ x PALLET	PESO L PESO N
<b>183</b>	<b>H114 L62 P18 cm</b> struttura sp. 16 mm		<b>H103 L58 P14 cm</b>  7 paia	0,166 mc <b>H116 L65 P22 cm</b> 12	16,5 kg 15,7 kg

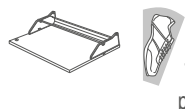
<b>183sp</b>	<b>H114 L62 P18 cm</b> struttura sp. 16 mm		<b>H103 L58 P14 cm</b>  7 paia	0,166 mc <b>H116 L65 P22 cm</b> 12	20,7 kg 19,9 kg
--------------	---	---	---	--	--------------------

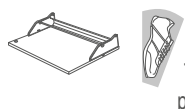
<b>184</b>	<b>H148 L62 P18 cm</b> struttura sp. 16 mm		<b>H137 L58 P14 cm</b>  10 paia	0,214 mc <b>H150 L65 P22 cm</b> 6	23,4 kg 22,4 kg
------------	---	---	--	---	--------------------

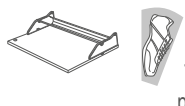
<b>184sp</b>	<b>H148 L62 P18 cm</b> struttura sp. 16 mm		<b>H137 L58 P14 cm</b>  10 paia	0,214 mc <b>H150 L65 P22 cm</b> 6	27,3 kg 26,3 kg
--------------	---	--	--	---	--------------------

<b>185</b>	<b>H182 L62 P18 cm</b> struttura sp. 16 mm		<b>H171 L58 P14 cm</b>  12 paia	0,263 mc <b>H184 L65 P22 cm</b> 6	27,0 kg 25,7 kg
------------	---	---	--	---	--------------------

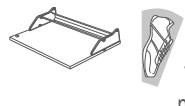
<b>185sp</b>	<b>H182 L62 P18 cm</b> struttura sp. 16 mm		<b>H171 L58 P14 cm</b>  12 paia	0,263 mc <b>H184 L65 P22 cm</b> 6	32,7 kg 31,4 kg
--------------	---	---	--	---	--------------------

E ESSENZA

S SPECCHIO

Pomoli in colore bianco se frontali con finitura Bianco Liscio, Pomoli cromo satinato se frontali con finitura Olmo Chiaro o Eucalipto. Maniglie in finitura struttura su ante con specchio. Apertura sincronizzata su art. 183, 183sp, 184, 184sp, 185, 185sp.

FINITURE STRUTTURA

FINITURE FRONTALI

- Bianco Liscio  
**E** - Eucalipto  
- Olmo Chiaro

- Bianco Liscio  
**E** - Eucalipto  
- Olmo Chiaro

- Bianco Liscio  
**E** - Eucalipto  
- Olmo Chiaro

**S** - Specchio Naturale

- Bianco Liscio  
**E** - Eucalipto  
- Olmo Chiaro

- Bianco Liscio  
**E** - Eucalipto  
- Olmo Chiaro

- Bianco Liscio  
**E** - Eucalipto  
- Olmo Chiaro







**S** - Specchio Naturale

- Bianco Liscio  
**E** - Eucalipto  
- Olmo Chiaro

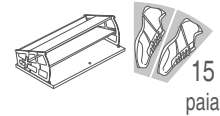
- Bianco Liscio  
**E** - Eucalipto  
- Olmo Chiaro

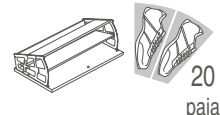
- Bianco Liscio  
**E** - Eucalipto  
- Olmo Chiaro

**S** - Specchio Naturale

CODICE	DIMENSIONI	INTERNO / ACCESSORI	RIPIANI DI SERIE	VOLUME PZ x PALLET	PESO L PESO N
<b>193</b>	<b>H121 L62 P29 cm</b> struttura sp. <b>16 mm</b>		<b>H112 L58 P25 cm</b>  15 paia	0,231 mc <b>H122 L63 P30 cm</b> 7	26,5 kg 26,1 kg
<b>194</b>	<b>H158 L62 P29 cm</b> struttura sp. <b>16 mm</b>		<b>H149 L58 P25 cm</b>  20 paia	0,301 mc <b>H159 L63 P30 cm</b> 4	33,1 kg 32,5 kg
<b>222</b>	<b>H80 L46 P34 cm</b> struttura sp. <b>16 mm</b>	 58	<b>H68 L42 P30 cm</b> 1 cod. <b>103/P</b> guide in plastica cassetto <b>H8 L39 P27 cm</b>	0,133 mc <b>H81 L47 P35 cm</b> 15	15,6 kg 15,4 kg
<b>222k</b> <b>kit</b>	<b>H80 L46 P34 cm</b> struttura sp. <b>16 mm</b>	 58	<b>H68 L42 P30 cm</b> 1 cod. <b>103/P</b> guide in plastica cassetto <b>H8 L39 P27 cm</b>	0,035 mc <b>H80 L48 P9 cm</b> 24	17,1 kg 15,4 kg
<b>242</b>	<b>H80 L31 P34 cm</b> struttura sp. <b>16 mm</b>		<b>H68 L28 P30 cm</b> 1 cod. <b>101/P</b>	0,091 mc <b>H81 L32 P35 cm</b> 18	12,2 kg 11,1 kg
<b>252</b>	<b>H105 L62 P34 cm</b> struttura sp. <b>16 mm</b>		<b>H92 L58 P30 cm</b> guide in plastica cassetto <b>H10 L55 P27 cm</b>	0,234 mc <b>H106 L63 P35 cm</b> 9	29,5 kg 29,0 kg

RIPIANI e ACCESSORI

CODICE	DIMENSIONI	FINITURA	CODICE	DIMENSIONI	FINITURA
<b>101/P</b>	<b>H27,6 L28,5 Sp1,0 cm</b>	Bianco Liscio	<b>103/P</b>	<b>H42,3 L28,5 Sp1,0 cm</b>	Bianco Liscio

E ESSENZA

FINITURE STRUTTURA

- Bianco Liscio  
**E** - Eucalipto  
- Olmo Chiaro

- Bianco Liscio  
**E** - Eucalipto  
- Olmo Chiaro

- Bianco Liscio  
**E** - Eucalipto  
- Olmo Chiaro

- Bianco Liscio  
**E** - Eucalipto  
- Olmo Chiaro

- Bianco Liscio  
**E** - Eucalipto  
- Olmo Chiaro

- Bianco Liscio  
**E** - Eucalipto  
- Olmo Chiaro

RIPIANI e ACCESSORI

CODICE	DIMENSIONI	FINITURA
<b>130K</b>	<b>H45,0 L40,0 P28,0 cm</b>	Bianco Liscio

Apertura mobile anta singola a dx. Pomoli in colore bianco se frontali con finitura  
Configurazione Bianco Liscio. Pomoli cromo satinato se frontali con finitura Olmo Chiaro o Eucalipto.  
Standard Pomoli cromo satinato sui modelli in KIT con qualsiasi finitura.

FINITURE FRONTALI

- Bianco Liscio  
**E** - Eucalipto  
- Olmo Chiaro









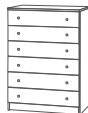
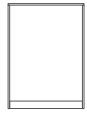

- Bianco Liscio  
**E** - Eucalipto  
- Olmo Chiaro

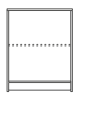
- Bianco Liscio  
**E** - Eucalipto  
- Olmo Chiaro

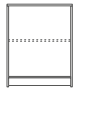
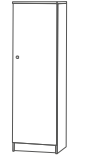

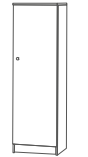
- Bianco Liscio  
**E** - Eucalipto  
- Olmo Chiaro

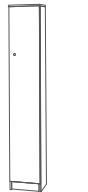
- Bianco Liscio  
**E** - Eucalipto  
- Olmo Chiaro

- Bianco Liscio  
**E** - Eucalipto  
- Olmo Chiaro

CODICE	DIMENSIONI	INTERNO / ACCESSORI	RIPIANI DI SERIE	VOLUME PZ x PALLET	PESO L PESO N
<b>253</b>	 H107 L77 P47 cm struttura sp. 16 mm		H94 L73 P44 cm guide in plastica cassetto H12 L70 P40 cm	0,404 mc H108 L78 P48 cm 4	44,5 kg 44,0 kg
<b>262</b>	 H80 L62 P34 cm struttura sp. 16 mm		H68 L58 P30 cm 1 cod. 104/P	0,179 mc H81 L63 P35 cm 9	17,4 kg 17,0 kg
<b>262k</b> <b>kit</b>	 H80 L62 P34 cm struttura sp. 16 mm		H68 L58 P30 cm 1 cod. 104/P	0,046 mc H80 L48 P12 cm 20	18,7 kg 17,0 kg
<b>302</b>	 H147 L46 P34 cm struttura sp. 16 mm		H135 L42 P30 cm 2 cod. 103/P	0,243 mc H148 L47 P35 cm 5	23,5 kg 23,0 kg
<b>302k</b> <b>kit</b>	 H147 L46 P34 cm struttura sp. 16 mm		H135 L42 P30 cm 2 cod. 103/P	0,063 mc H146 L48 P9 cm 20	24,9 kg 23,0 kg
<b>313</b>	 H183 L31 P34 cm struttura sp. 16 mm		H171 L28 P30 cm 3 cod. 101/P	0,206 mc H184 L32 P35 cm 6	24,1 kg 23,5 kg

RIPIANI e ACCESSORI

CODICE	DIMENSIONI	FINITURA	CODICE	DIMENSIONI	FINITURA
<b>101/P</b>	 H27,6 L28,5 Sp1,0 cm	Bianco Liscio	<b>103/P</b>	 H42,3 L28,5 Sp1,0 cm	Bianco Liscio

E ESSENZA

FINITURE STRUTTURA

- Bianco Liscio  
**E** - Eucalipto  
- Olmo Chiaro

- Bianco Liscio  
**E** - Eucalipto  
- Olmo Chiaro

- Bianco Liscio  
**E** - Eucalipto  
- Olmo Chiaro

- Bianco Liscio  
**E** - Eucalipto  
- Olmo Chiaro

- Bianco Liscio  
**E** - Eucalipto  
- Olmo Chiaro

- Bianco Liscio  
**E** - Eucalipto  
- Olmo Chiaro

RIPIANI e ACCESSORI

CODICE	DIMENSIONI	FINITURA	CODICE	DIMENSIONI	FINITURA
<b>104/P</b>	 H58,4 L28,5 Sp1,0 cm	Bianco Liscio	<b>130K</b>	 H45,0 L40,0 P28,0 cm	Bianco Liscio

Apertura mobile anta singola a dx. Pomoli in colore bianco se frontali con finitura  
Configurazione Standard Bianco Liscio. Pomoli cromo satinato se frontali con finitura Olmo Chiaro o Eucalipto.  
Pomoli cromo satinato sui modelli in KIT con qualsiasi finitura.

FINITURE FRONTALI

- Bianco Liscio  
**E** - Eucalipto  
- Olmo Chiaro







- Bianco Liscio  
**E** - Eucalipto  
- Olmo Chiaro

- Bianco Liscio  
**E** - Eucalipto  
- Olmo Chiaro

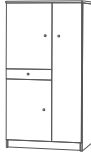
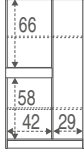
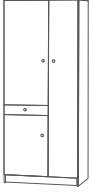
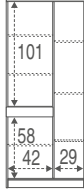
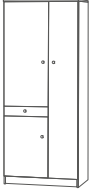
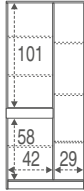
- Bianco Liscio  
**E** - Eucalipto  
- Olmo Chiaro

- Bianco Liscio  
**E** - Eucalipto  
- Olmo Chiaro

- Bianco Liscio  
**E** - Eucalipto  
- Olmo Chiaro

CODICE	DIMENSIONI	INTERNO / ACCESSORI	RIPIANI DI SERIE	VOLUME PZ x PALLET	PESO L PESO N
<b>322</b>	 H147 L77 P34 cm struttura sp. 16 mm	 H135 L73 P33 cm guide in plastica cassetto H8 L39 P27 cm	4 cod. 102/P - 103/P 1 tramezza orizzontale fissa 1 tramezza verticale fissa	0,404 mc H148 L78 P35 cm 3	39,0 kg 38,6 kg
<b>323</b>	 H183 L77 P34 cm struttura sp. 16 mm	 H171 L73 P30 cm guide in plastica cassetto H8 L39 P27 cm	6 cod. 102/P - 103/P 1 tramezza orizzontale fissa 1 tramezza verticale fissa	0,502 mc H184 L78 P35 cm 3	50,0 kg 49,2 kg
<b>323k</b> <b>kit</b>	 H183 L77 P34 cm struttura sp. 16 mm	 H171 L73 P30 cm guide in plastica cassetto H8 L39 P27 cm	6 cod. 102/P - 103/P 1 tramezza orizzontale fissa 1 tramezza verticale fissa	0,126 mc H187 L48 P14 cm 16	52,1 kg 49,2 kg
<b>342</b>	 H80 L77 P34 cm struttura sp. 16 mm	 H68 L73 P30 cm guide in plastica cassetto H8 L39 P27 cm	2 cod. 102/P - 103/P 1 tramezza verticale fissa	0,221 mc H81 L78 P35 cm 9	22,7 kg 22,3 kg
<b>342k</b> <b>kit</b>	 H80 L77 P34 cm struttura sp. 16 mm	 H68 L73 P30 cm guide in plastica cassetto H8 L39 P27 cm	2 cod. 102/P - 103/P 1 tramezza verticale fissa	0,054 mc H80 L48 P14 cm 20	24,1 kg 22,3 kg
<b>370</b>	 H59 L62 P21 cm struttura sp. 16 mm	 H56 L58 P17 cm	1 cod. 115/P	0,088 mc H61 L63 P23 cm 21	10,5 kg 9,8 kg

RIPIANI e ACCESSORI

CODICE	DIMENSIONI	FINITURA	CODICE	DIMENSIONI	FINITURA
<b>102/P</b>	H29,1 L28,5 Sp1,0 cm	Bianco Liscio	<b>103/P</b>	H42,3 L28,5 Sp1,0 cm	Bianco Liscio

E ESSENZA

FINITURE STRUTTURA

- Bianco Liscio  
E - Eucalipto  
- Olmo Chiaro

- Bianco Liscio  
E - Eucalipto  
- Olmo Chiaro

- Bianco Liscio  
E - Eucalipto  
- Olmo Chiaro

- Bianco Liscio  
E - Eucalipto  
- Olmo Chiaro

- Bianco Liscio  
E - Eucalipto  
- Olmo Chiaro

E - Bianco Liscio

FINITURE FRONTALI

- Bianco Liscio  
E - Eucalipto  
- Olmo Chiaro

- Bianco Liscio  
E - Eucalipto  
- Olmo Chiaro

- Bianco Liscio  
E - Eucalipto  
- Olmo Chiaro

- Bianco Liscio  
E - Eucalipto  
- Olmo Chiaro

- Bianco Liscio  
E - Eucalipto  
- Olmo Chiaro

E - Bianco Liscio

RIPIANI e ACCESSORI

CODICE	DIMENSIONI	FINITURA	CODICE	DIMENSIONI	FINITURA
<b>115/P</b>	H58,3 L17,0 Sp1,0 cm	Bianco Liscio	<b>130K</b>	H45,0 L40,0 P28,0 cm	Bianco Liscio

CODICE	DIMENSIONI	INTERNO / ACCESSORI	RIPIANI DI SERIE	VOLUME PZ x PALLET	PESO L PESO N
<b>380</b>	<b>H59 L46 P21</b> cm struttura sp. 16 mm		<b>H56 L42 P17</b> cm 1 cod. <b>114/P</b>	0,066 mc <b>H61 L47 P23</b> cm 28	8,5 kg 7,9 kg
<b>452</b>	<b>H183 L46 P34</b> cm struttura sp. 16 mm		<b>H171 L42 P30</b> cm 3 cod. <b>103/P</b> guide in plastica cassetto 1 tramezza orizzontale fissa <b>H8 L39 P27</b> cm	0,303 mc <b>H184 L47 P35</b> cm 5	31,0 kg 30,5 kg
<b>452k</b>	<b>H183 L46 P34</b> cm struttura sp. 16 mm		<b>H171 L42 P30</b> cm 3 cod. <b>103/P</b> guide in plastica cassetto 1 tramezza orizzontale fissa <b>H8 L39 P27</b> cm	0,082 mc <b>H189 L48 P9</b> cm 20	32,6 kg 30,5 kg
<b>455k</b> <b>kit</b>	<b>H182 L77 P52</b> cm struttura sp. 16 mm	 barra porta-abiti	<b>H171 L73 P47</b> cm 1 cod. <b>139/P</b> 1 tramezza orizzontale fissa	0,139 mc <b>H187 L57 P13</b> cm 8	62,1 kg 59,8 kg
<b>456k</b> <b>kit</b>	<b>H182 L77 P52</b> cm struttura sp. 16 mm	 barra porta-abiti	<b>H171 L73 P47</b> cm 1 cod. <b>139/P</b> guide in plastica cassetto 1 tramezza orizzontale fissa <b>H12 L70 P40</b> cm	0,139 mc <b>H187 L57 P13</b> cm 8	64,9 kg 62,5 kg
<b>457dk</b> <b>kit</b>	<b>H182 L115 P52</b> cm struttura sp. 16 mm	 barra porta-abiti	<b>H171 L111 P47</b> cm 4 cod. <b>139/P - 140/P</b> guide in plastica cassetto 1 tramezza orizzontale fissa 1 tramezza verticale fissa <b>H12 L70 P40</b> cm	STRUTTURA 0,139 mc <b>H187 L57 P13</b> cm 8 FRONTALI 0,063 mc <b>H146 L48 P9</b> cm 20	43,6 kg 42,50 kg 29,5 kg 28,3 kg

RIPIANI e ACCESSORI

CODICE	DIMENSIONI	FINITURA	CODICE	DIMENSIONI	FINITURA
<b>103/P</b>	<b>H42,3 L28,5 Sp1,0</b> cm	Bianco Liscio	<b>114/P</b>	<b>H42,4 L17,0 Sp1,0</b> cm	Bianco Liscio

E ESSENZA

FINITURE STRUTTURA

**E** - Bianco Liscio

**E** - Bianco Liscio  
- Eucalipto  
- Olmo Chiaro

**E** - Bianco Liscio  
- Eucalipto  
- Olmo Chiaro

**E** - Bianco Liscio  
- Eucalipto

**E** - Bianco Liscio  
- Eucalipto

**E** - Bianco Liscio  
- Eucalipto

FINITURE FRONTALI

**E** - Bianco Liscio

**E** - Bianco Liscio  
- Eucalipto  
- Olmo Chiaro

**E** - Bianco Liscio  
- Eucalipto  
- Olmo Chiaro

**E** - Bianco Liscio  
- Eucalipto

**E** - Bianco Liscio  
- Eucalipto

**E** - Bianco Liscio  
- Eucalipto

RIPIANI e ACCESSORI

CODICE	DIMENSIONI	FINITURA	CODICE	DIMENSIONI	FINITURA
<b>139/P</b>	<b>H73,1 L45,4 Sp1,4</b> cm	Bianco Liscio	<b>140/P</b>	<b>H36,3 L45,4 Sp1,4</b> cm	Bianco Liscio

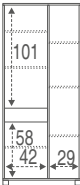

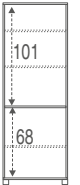
CODICE	DIMENSIONI	INTERNO / ACCESSORI	RIPIANI DI SERIE	VOLUME PZ x PALLET	PESO L PESO N
<b>623k</b> <b>Kit</b>	<b>H178 L77 P34</b> cm struttura sp. <b>16 mm</b>	 <b>H171 L71 P30</b> cm guide a rullo cassetto <b>H8 L39 P27</b> cm	<b>6</b> cod. <b>102/P - 103/P</b> 1 tramezza orizzontale fissa 1 tramezza verticale fissa	<b>0,126</b> mc <b>H187 L48 P14</b> cm 16	<b>53,5</b> kg <b>52,0</b> kg

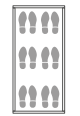
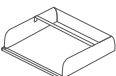
<b>668k</b> <b>Kit</b>	<b>H178 L62 P34</b> cm struttura sp. <b>16 mm</b>	 <b>H171 L58 P30</b> cm	<b>3</b> cod. <b>104/P</b> 1 tramezza orizzontale fissa	<b>0,079</b> mc <b>H188 L38 P11</b> cm 20	<b>40,2</b> kg <b>39,4</b> kg
------------------------	--	---	--	---	----------------------------------

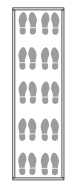
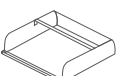
<b>As103</b>	<b>H104 L50 P14</b> cm struttura sp. <b>20 mm</b>	 <b>H100 L46 P13</b> cm	 <b>6</b> paia	<b>0,085</b> mc <b>H107 L53 P15</b> cm 22	<b>11,5</b> kg <b>10,8</b> kg
--------------	--	---	--	---	----------------------------------

<b>As105</b>	<b>H168 L50 P14</b> cm struttura sp. <b>20 mm</b>	 <b>H164 L46 P13</b> cm	 <b>10</b> paia	<b>0,135</b> mc <b>H170 L53 P15</b> cm 11	<b>18,4</b> kg <b>17,6</b> kg
--------------	--	--	---	---	----------------------------------

<b>As203</b>	<b>H136 L34 P25</b> cm struttura sp. <b>20 mm</b>	 <b>H132 L30 P24</b> cm cestello <b>H34 L26 P22</b> cm <b>16litri</b> <b>x3</b>		<b>0,177</b> mc <b>H143 L40 P31</b> cm 8	<b>13,0</b> kg <b>12,0</b> kg
--------------	--	--	---	--	----------------------------------

<b>As204</b>	<b>H92 L60 P25</b> cm struttura sp. <b>20 mm</b>	 <b>H88 L56 P24</b> cm cestello <b>H34 L26 P22</b> cm <b>16litri</b> <b>x4</b>		<b>0,157</b> mc <b>H94 L62 P27</b> cm 8	<b>17,0</b> kg <b>16,0</b> kg
--------------	---	---	---	---	----------------------------------

RIPIANI e ACCESSORI

CODICE	DIMENSIONI	FINITURA	CODICE	DIMENSIONI	FINITURA
<b>102/P</b>	<b>H29,1 L28,5 Sp1,0</b> cm	Bianco Liscio	<b>103/P</b>	<b>H42,3 L28,5 Sp1,0</b> cm	Bianco Liscio

FINITURE STRUTTURA	FINITURE FRONTALI
<b>E</b> - Bianco Fiammato - Olmo Chiaro	<b>E</b> - Bianco Fiammato - Olmo Chiaro

<b>E</b> - Bianco Fiammato - Olmo Chiaro	<b>E</b> - Bianco Fiammato - Olmo Chiaro
---	---

<b>M</b> - Bianco - Nero	<b>M</b> - Bianco - Nero
-----------------------------	-----------------------------

<b>M</b> - Bianco - Nero	<b>M</b> - Bianco - Nero
-----------------------------	-----------------------------

<b>M</b> - Bianco	<b>M</b> - Bianco
-------------------	-------------------

<b>M</b> - Bianco	<b>M</b> - Bianco
-------------------	-------------------

RIPIANI e ACCESSORI

CODICE	DIMENSIONI	FINITURA	CODICE	DIMENSIONI	FINITURA
<b>104/P</b>	<b>H58,4 L28,5 Sp1,0</b> cm	Bianco Liscio	<b>130K</b>	<b>H45,0 L40,0 P28,0</b> cm	Bianco Liscio



*lifestyle Home*



# CONDIZIONI GENERALI DI VENDITA

## Ordini

Gli ordini sono accettati con la clausola “salvo approvazione della Casa”.

Gli ordini anticipati telefonicamente dovranno essere seguiti da conferma scritta: contrariamente non ci assumeremo la responsabilità per eventuali errori di consegna. Per la realizzazione di articoli su misura, solo dopo parere consensuale dell'ufficio commerciale, verrà applicata una maggiorazione sul prezzo di listino.

## Consegna

Le consegne saranno effettuate nei termini concordati con il nostro ufficio commerciale. La mancata o ritardata consegna, anche se pattuita, per causa di forza maggiore non costituisce alcun diritto per il cliente a risarcimento danni. Le consegne richieste con spedizione a mezzo corriere espresso viaggiano in porto assegnato. Non si effettuano consegne ai privati.

## Reclami

Le contestazioni per danni derivanti dal trasporto devono essere fatte al momento dello scarico. Eventuali reclami per difetti di fabbricazione dovranno essere comunicati entro 8 giorni dal ricevimento della merce.

Viene declinata ogni responsabilità per errori o anomalie riscontrate nel montaggio di nostri modelli, salvo non sia stato effettuato da nostro personale specializzato.

## Resi

I resi per difetto di fabbricazione dovranno essere preventivamente autorizzati per iscritto e dovranno pervenire perfettamente imballati. Qualora, ad insindacabile giudizio dell'azienda vengano riconosciuti i difetti contestati, gli stessi verranno accreditati al valore effettivamente pagato.

## Pagamenti

Non sono validi i pagamenti se non fatti direttamente alla nostra sede.

In caso di ritardato pagamento decorreranno gli interessi commerciali nella misura del tasso ufficiale di sconto aumentato di 7 punti (DL 231 del 09.10.02). Clausola di riserva di proprietà. La merce rimane di nostra proprietà fino a completo pagamento della fattura di riferimento.

## Foro competente

Per ogni controversia il foro competente è eletto a Reggio Emilia.

Il presente listino annulla e sostituisce il precedente e potrà essere modificato senza preavviso alcuno in ragione degli aumenti delle materie prime, del costo della manodopera e quant'altro potrà verificarsi in maniera imprevedibile.

Le descrizioni e le caratteristiche tecniche dei prodotti richiamati nel presente listino sono puramente indicativi e non vincolanti. L'azienda si riserva il diritto di modificare, senza alcun preavviso i materiali e le caratteristiche tecniche dei prodotti per motivi tecnici e/o produttivi. Le misure indicate sono espresse in centimetri e in pollici.



### **ATTENZIONE:**

Fissare con accuratezza i mobili alla parete per evitarne il pericoloso ribaltamento.  
Non appoggiare oggetti pesanti sopra i mobili.  
Mettere gli oggetti più pesanti nei cassetti in basso.  
Impedire che i bambini si arrampichino o si appendano ai cassetti, alle ante o ai ripiani.





**SARMOG**

Via Pizzamiglia, 7  
42016 San Girolamo di Guastalla RE / Italy  
Tel.: 0522 / 228058 Fax: 0522 / 228442  
info@sarmog.com - www.sarmog.com