



ceramica Artistica Vietrese

Giovanni DeMaio



l'antica arte di preziose mattonelle fatte a mano
the ancient art of fine handmade tiles

Ceramica Artistica Vietrese



ceramica Artistica Vietrese

Giovanni De Maio





Indice. *index*

Notizie utili	pag. 08	13x13	pag. 68	Liscio o bombato 3x20	pag. 114
Giuda alla consultazione	pag. 09	I decori	pag. 70	I pannelli decorativi	pag. 116
I fondi pennellati	pag. 10	I festoni	pag. 76	Le piastrelle a rilievo	pag. 122
I fondi spugnati	pag. 12	10x10	pag. 80	Gli stucchi Levia	pag. 124
20x20	pag. 14	I decori	pag. 82	I complementi	pag. 142
Le fornaci	pag. 16	I festoni	pag. 90	Sezione tecnica	pag. 148
Le geometrie	pag. 20	I listelli 10x20	pag. 94		
I piccoli fiori	pag. 24	I listelli sagomati 10x20	pag. 100		
I giardini vietresi	pag. 26	I listelli 6,5x26	pag. 104		
I classici	pag. 36	I listelli 5x20	pag. 108		
I decori su spuganto	pag. 38	I torcelli 5x20	pag. 112		
Mediterranea	pag. 40				
I festoni 20x20	pag. 58				



C'è nella ceramica della Giovanni De Maio un soffio vitale che dà anima alla sua produzione.

È la piastrella che diventa arte, come se la natura avesse chiesto all'artista di essere immortalata, come se la storia di un paese avesse chiesto all'uomo di essere narrata. E questo ciò che la Giovanni De Maio, da oltre quattro generazioni, con impegno fedele, continua a fare come a sostegno di una silenziosa promessa. La sua produzione è la rappresentazione stessa della solarità mediterranea che da sempre ha fatto da sfondo alla sua storia personale. Dalle sue ceramiche riaffiora la vita palpitante di un paese che, con le sue stradine dal sapore mediterraneo, le sue case bianche, le botteghe degli artigiani, da sempre ha fatto da culla alla ceramica Giovanni De Maio: Vietri sul Mare, porta d'ingresso all'esplosione paesaggistica della Costiera Amalfitana.

The lifeblood of Giovanni De Maio ceramics courses through its production lines.

That lifeblood comes from the vision of tiles as an art form; as if Nature had urged the artist to celebrate its existence in them, as if a town had asked man to tell its story through them. This vision is what Giovanni De Maio has committed himself to for over four generations, working constantly, as though upholding a silent promise. The ceramics are the very image of the Mediterranean brightness that always served as a background to the business's own history. They express the bustling life of a town that, with its narrow Mediterranean roads, its white houses and its craft shops, has always nurtured the soul of Giovanni De Maio ceramics: Vietri sul Mare, the first sparks of the visual explosion that is the landscape of the Amalfi coast.



l'antica arte di preziose mattonelle fatte a mano
The ancient art of fine handmade tiles





I colori dei decori sono rubati alla tavolozza del cielo e del mare, ai limoni, alle ginestre ed ai glicini, che punteggiano di tocchi variopinti i verdi declini della costa. Le ceramiche di Giovanni De Maio sanno evocare tutto ciò in un accurato capolavoro di sintesi, che riesce a trasformare il tempo in una astrazione, dove il passato si mescola al presente per tramandare di padre in figlio, con immutata fedeltà, l'arte del decoro.



The shades of the decorations have been stolen from the sky and the sea, and from the lemon trees, genista shrubs and wisteria that splash colour over the greenery of the coastline. Giovanni De Maio ceramics conjure up the essence of this scenery in a careful masterpiece, which transforms time into an abstraction and the past runs into the present, as the art of decoration is handed down, with unswerving reliability, from father to son.





Notizie utili

Il Bianco Vietri

Il nostro smalto “Bianco Vietri” , di antica formulazione vietrese, è la base unica di tutta la nostra produzione. È un'esclusiva miscelazione di fondenti e sabbie marine, che conferisce alla superficie ceramica una particolare trasparenza e luminosità, esaltando la policromia tipica dei nostri prodotti. Frutto delle tradizioni e dell'esperienza di quattro generazioni di ceramisti, che hanno fatto la storia della nostra azienda, il “Bianco Vietri” da noi prodotto è garanzia di eccezionale durezza e resistenza all'usura, ed ha una pregevole qualità estetica. Leggere stonalizzazioni o puntinature della superficie sono da considerarsi una caratteristica del nostro prodotto e non un difetto.

I Pennellati e gli Spugnati

Sono disponibili in tutti i formati presentati nelle pagine tecniche e vengono realizzati su richiesta.

I Decor

Le decorazioni in catalogo possono essere realizzate anche in versioni differenti per formato e colori da quelle presentate. Per le scelte cromatiche si utilizzerà la gamma dei colori Pennellati. È, inoltre, possibile apportare modifiche o realizzare decori su specifico disegno del cliente. In tali casi è opportuno contattare la nostra direzione commerciale per richiedere ulteriori informazioni.

I Complementi

La nostra direzione commerciale è a vostra completa disposizione per fornirvi tutte le informazioni su eventuali richieste di oggetti diversi nella forma e nell'uso da quelli presentati in catalogo.

Pubblicazioni precedenti

Il presente catalogo e le precedenti pubblicazioni si integrano a vicenda. È possibile, quindi, scegliere i decori presentati nei nostri cataloghi e realizzarli su supporto diverso. I decori esclusi da questa pubblicazione restano comunque in produzione.

Useful information

Il Bianco Vietri

Our glaze Bianco Vietri is an old formula developed in Vietri and it is the base of our entire production. Bianco Vietri is an exclusive mixture of fluxes and sea-sands which gives a particular glow of transparency and luminosity to the surface of the ceramics emphasizing the typical polychromy of the products. It is the result of tradition and experience of four generations of ceramists, who founded the history of our company. Bianco Vietri made by us guarantees an exceptional hardness and resistance to our products for utility, as well as an excellent aesthetic quality. Slight shade variation or dotted surfaces are to be considered as natural characteristics of our ceramics and not to be taken as defects.

I Pennellati and Spugnati

They are available in any size demonstrated in the technical tables of the catalogue and hand-made requirements are made on request.

The Patterns

The patterns shown in the catalogue can be also created in different sizes and colours; for chromatic choices the range of Pennellati colours will be used. It is also possible to modify or create patterns with particulars design demanded by clients. For further information please contact our Commercial Sales Department.

The Accessories

Our Commercial Sales Department is at your disposition to provide you with all the information for orders of items different in shapes or use from those shown in the catalogue.

Previous publications

This catalogue and previous publications integrate each other. You can therefore select the decorations presented in our catalogues and apply them on a different base. Decorations not included in this publication are still however in production.

Guida alla consultazione

LEGENDA

SOFIA



Nelle sezioni 20x20, 13x13 e 10x10 la presenza di questo simbolo nel codice dell'articolo indica l'esistenza in catalogo di un corrispondente decoro nelle sezione dei listelli.

SOFIA



Nelle sezioni dei listelli la presenza di questo simbolo nel codice dell'articolo indica l'esistenza in catalogo di un corrispondente decoro in forma quadrata.



Bianco Vietri

Consultation guide

KEY

SOFIA



In the 20x20, 13x13, 10x10 sections the presence of this symbol in the code of the item indicates the possibility of having the “Listello” section of the catalogue.

SOFIA



In the “Listello” section the presence of this symbol in the code of the item indicates the possibility of having the same corresponding decorations in a square shape.



I Pennellati



L'antica arte di preziosa materielle fatta a mano. The ancient art of fine handmade tiles.



I Fondi Pennellati.

Colori disponibili per realizzare decori e pavimentazione. *Colours available for decorations and flooring*



Sullo smalto a crudo il colore viene distribuito a pennello in due passaggi successivi ed in verso opposto. Questa tecnica garantisce una maggiore uniformità cromatica ed il lento assorbimento del colore ne aumenta il grado di resistenza. La superficie presenta striature con toni di colori sempre diversi a testimonianza dell'assoluta artigianalità della lavorazione.

The colour is distributed on the raw glaze by brush in two separate coats, done in opposite directions. This technique guarantees a better chromatic uniformity and the slow absorbing of colours makes it more resistant. The surface presents striations with shades of colours, always different, which witness to the craftsmanship of our manufacturing.



BIANCO VIETRI

30x30	Q103	10x20	Q88	6,5x26	Z13	spigolo torcello	Z23	3x20/3x13 liscio o bombato	Z16	8x20/3x20/3x13 battiscopa	L35
15x30	Q57	10x20 sagomato	L50	6,5x6,5	Z9	angolo torcello	Z23	spigolo o angolo bombato	Z23	3x20/3x13 sguscie	Z16
7,5x30	Z13	10x10	Q67	5x20	Z10	spigolo sagomato	Z22	1x20/1,5x26	Z16	unghie-piè d'oca	Z23
20x20	Q46	13x13	Q58	5x5	Z5	angolo sagomato	Z27	1x20/1x13 matita jolly	Z18	10x10 serie torelli	Z30



FONDI PENNELLATI

30x30	Q120	10x20	Q108	6,5x26	Z21	spigolo torcello	Z29	3x20/3x13 liscio o bombato	Z21	8x20/3x20/3x13 battiscopa	L50
15x30	Q76	10x20 sagomato	L70	6,5x6,5	Z11	angolo torcello	Z29	spigolo o angolo bombato	Z25	3x20/3x13 sguscie	Z21
7,5x30	Z21	10x10	Q85	5x20	Z17	spigolo sagomato	Z24	1x20/1,5x26	Z21	unghie-piè d'oca	Z25
20x20	Q60	13x13	Q73	5x5	Z8	angolo sagomato	Z29	1x20/1x13 matita jolly	Z23	10x10 serie torelli	Z32

L'antica arte di preziosa mattonelle fatta a mano. The ancient art of fine handmade tiles.

I Fondi Spugnati.



Lilla Grigio Celeste Azzurro Turchese Blu
 Verde Rame Verde Nilo Avana Manganese Rosa Antico Rosa
 Rosso Giallo Giallo Arancio Arancio

In questo tipo di lavorazione la spugna di mare sostituisce il pennello. Il risultato è una superficie morbida e cangiante.
In this kind of manufacturing, the natural sea-sponge substitutes the brush. The result is a soft and changing colour of the surface.

FONDI SPUGNATI

30x30	Q138	10x20 sagomato	L75	5x20	Z22	angolo torcello	Z31	spigolo o angolo bombato	Z27	unghie-piè d'oca	Z27
20x20	Q88	10x10	Q104	5x20/5x13 torcello	Z29	spigolo sagomato	Z26	1x20/1x13 matita jolly	Z27	10x10 serie torelli	Z34
13x13	Q88	6,5x26	Z23	5x5	Z9	angolo sagomato	Z30	8x20/3x20/3x13 battiscopa	L55		
10x20	Q118	6,5x6,5	Z12	spigolo torcello	Z31	3x20/3x13 liscio o bombato	Z25	3x20/3x13 sguscie	Z23		





20x20 8x8 inc.

Tutti i decori possono essere realizzati in versione di colore differenti da quelli proposti, utilizzando per la scelta la gamma dei colori pennellati. Su richiesta è possibile la realizzazione di altri decori.



All the decorations can be created in different colours from the ones proposed, choosing amongst the range of Pennellati colours. It is possible to create other decorations on demand.



Le Fornaci 20x20 8x8 inc.

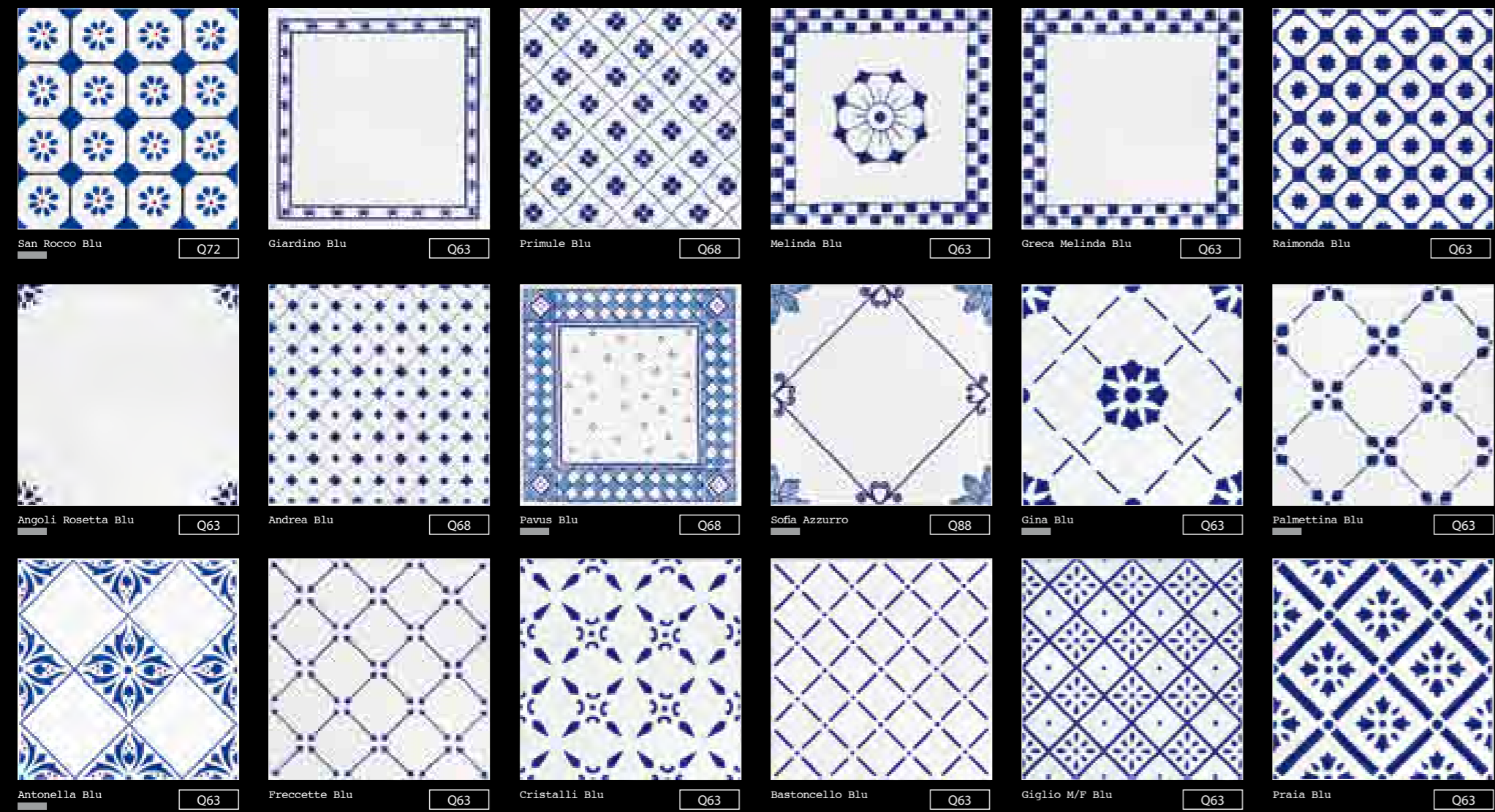

Le Fornaci 20x20 8x8 inc.

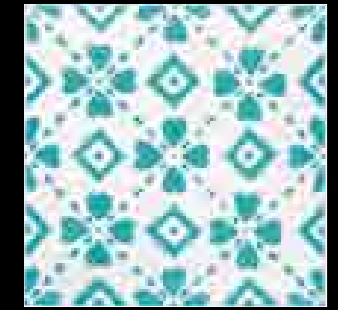

Scalea Verde Nilo Q63

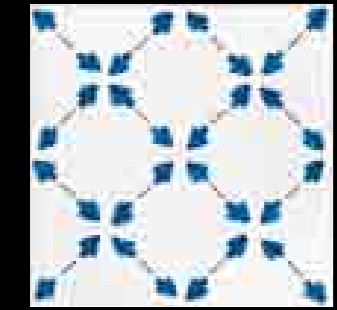

Palmetta Turchese Q128

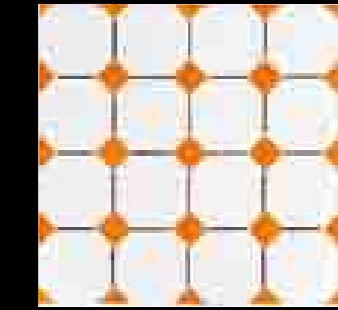

San Rocco S/F Arancio Q70



Potenza Q128



Pizzo Antico Rosso Q128

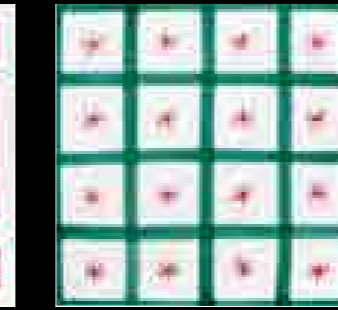

Scozzese Verde Rame Q128

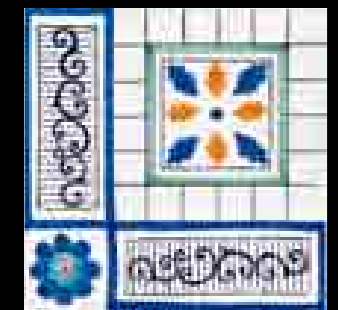

Anemone Q128

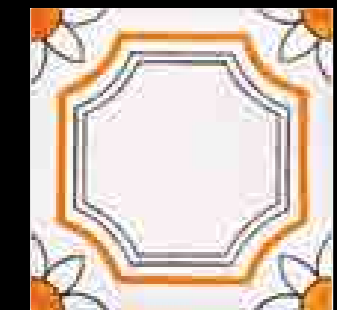

Agropoli Arancio Q98

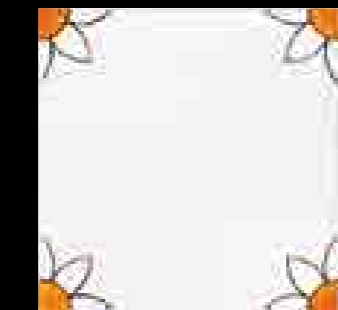

Spigoli Agropoli Arancio Q93



L'antica arte di preziosa materielle fatta a mano. The ancient art of fine handmade tiles.

Le Geometrie 20x20 8x8 inc.

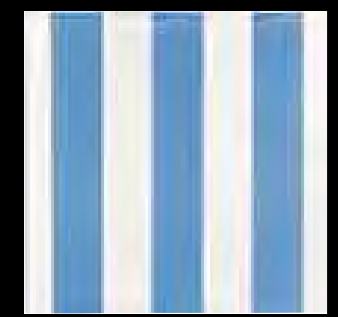

Linea 3 Azzurro Q63

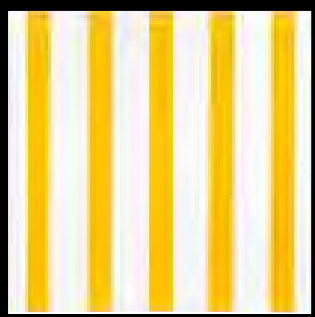

Linea 5 Giallo Arancio Q63

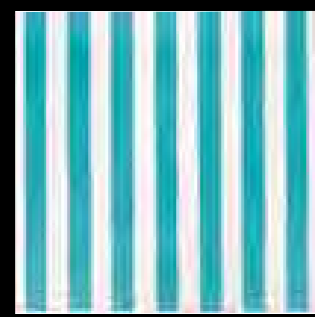

Linea 7 Verde Nilo Q63

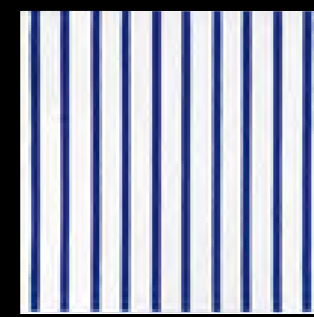

Linea 10 Blu Q63

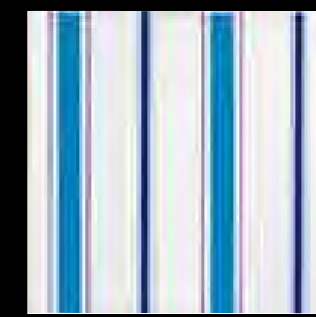

Linea 12 Blu Azzurro Q68

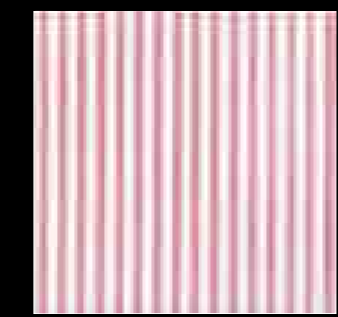

Linea 16 Rosa Q63



Bordino Blu Q73

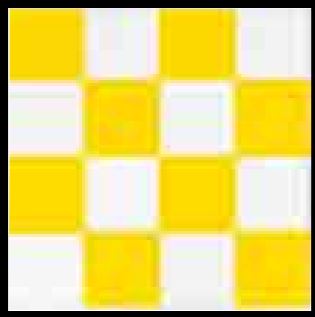

Scacchiera Giallo Q63

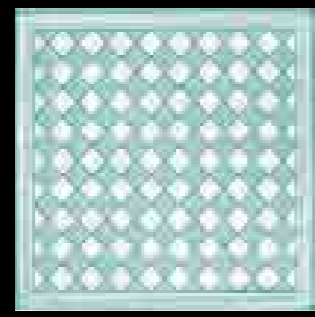

Dado Verde Nilo Q93

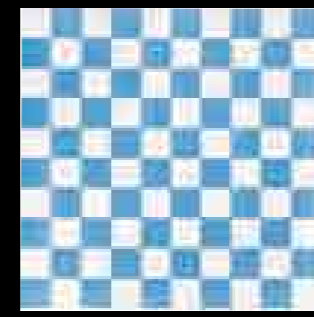

Roberta Celeste Q63

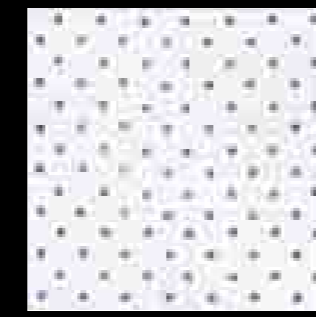

Amanda Blu Q63



Filetto Amalia Blu Q63

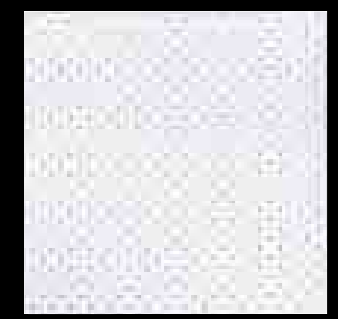

Puntinato Blu Q63



Quattro Angoli Nero Q78



Vecchia Taormina Blu Q68



Vecchia Taormina Rosa Grigio Q73

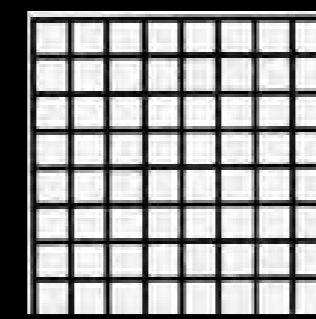

Quaderno Nero Q63

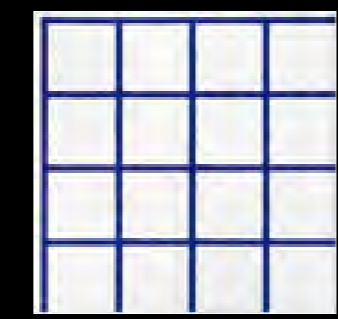

Rete Grande Blu Q63



Le Geometrie 20x20 8x8 inc.



Composizione Spigoli



Rivestimento: "Le Geometrie" Spigoli Blu 13x13. Bombato Pennellato Blu 3x20. Torello Bianco 10x10. dal catalogo "Cotto Salernitano" Rodi Blu 10x10.

L'antica arte di preziosa materielle fatta a mano. The ancient art of fine handmade tiles.

I Piccoli Fiori 20x20 8x8 inc.



Emma Azzurro Q70



Grazia Rosso Q68

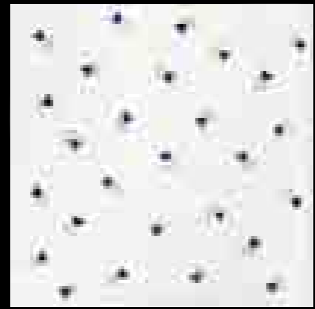

Campanelle Blu Q68



Rose Rosse Q93



Fiordaliso Azzurro Q93



Gemme Rosa Q93



Giulia Giallo Arancio Q68

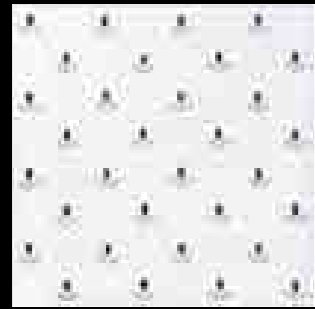

Gocce Blu Q68

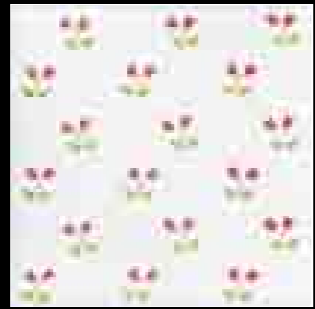

Lia Rosso Q68



Still life realizzato con Grazia Rosso e Giulia Giallo Arancio.



Still life della serie "I Piccoli Fiori" realizzato con diversi formati.



Rivestimento: "I Piccoli Fiori" Fiordaliso Azzurro 20x20. Bombato Pennellato Azzurro 3x20.
"Le Geometrie" Linea 5 Azzurro 20x20. Sagomato Fiordaliso Azzurro 10x20
Pavimento: "I Pennelati" Azzurro 20x20.

L'antica arte di preziosa materielle fatta a mano. The ancient art of fine handmade tiles.

I Giardini Vietresi 20x20 8x8 inc.



Maurizia Q128



Serto Circolare Q128



Flora Q128

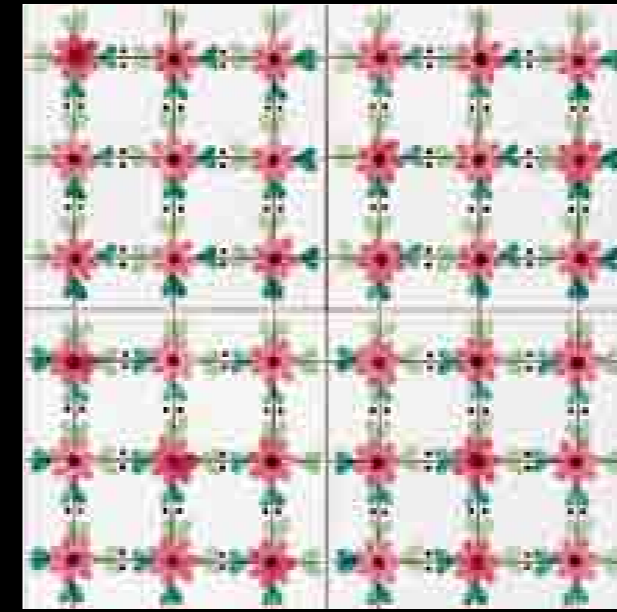

Fazzoletto Q148

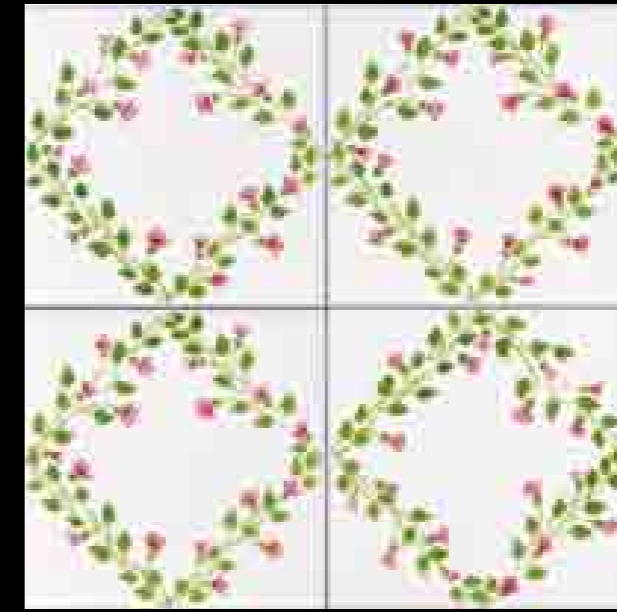

Albenga Rosa Q103



Gilda Blu Q128

L'antica arte di preziosa materielle fatta a mano. The ancient art of fine handmade tiles.

I Giardini Vietresi 20x20 8x8 inc.



Fiori Sparsi Q128



Primavera Q128



Favignana Q128



Prato Fiorito Q183

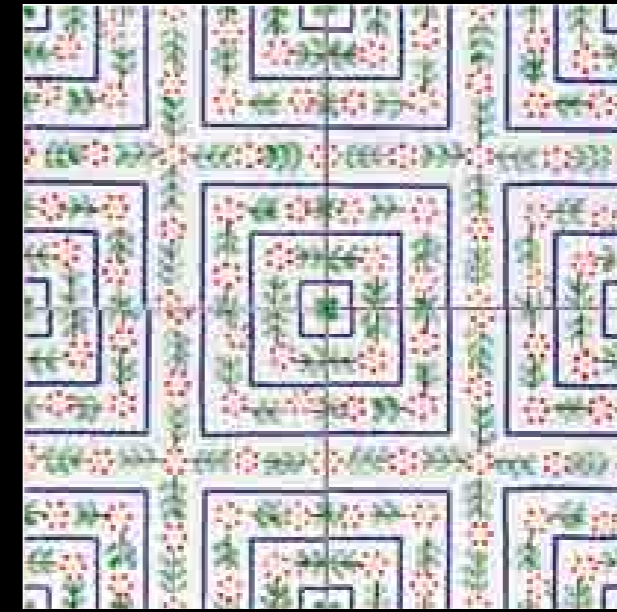

Serra Q183



Fiore Stilizzato Q128

L'antica arte di preziose mattonelle fatte a mano. The ancient art of fine handmade tiles.

I Giardini Vietresi 20x20 8x8 inc.

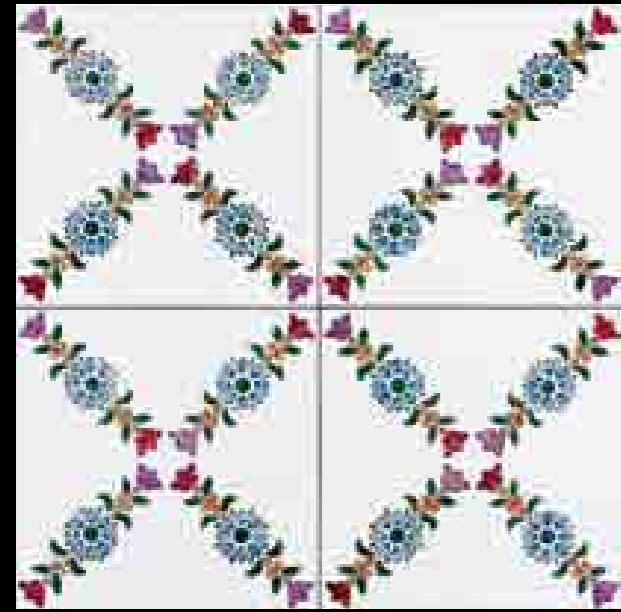

Pergola

Q128



Clelia

Q128

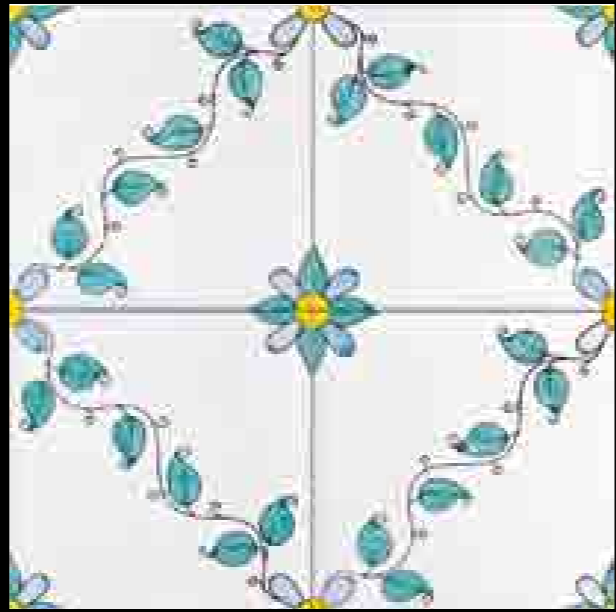

Leda

Q128



Serto Fiorito e Terminale

Q128

L65

Rivestimento: "I Giardini Vietresi" Serto Fiorito e Terminale 20x20. Bianco Vietri 20x20.
Listello Bombato Verde Rame 3x20. Sagomato Serto Fiorito 10x20
Pavimento: "I Pennelati" Verde Rame 20x20.

L'antica arte di preziosa materielle fatta a mano. The ancient art of fine handmade tiles.



I Giardini Vietresi 20x20 8x8 inc.



Cinzia

Q128



Campanule Rosa

Q128

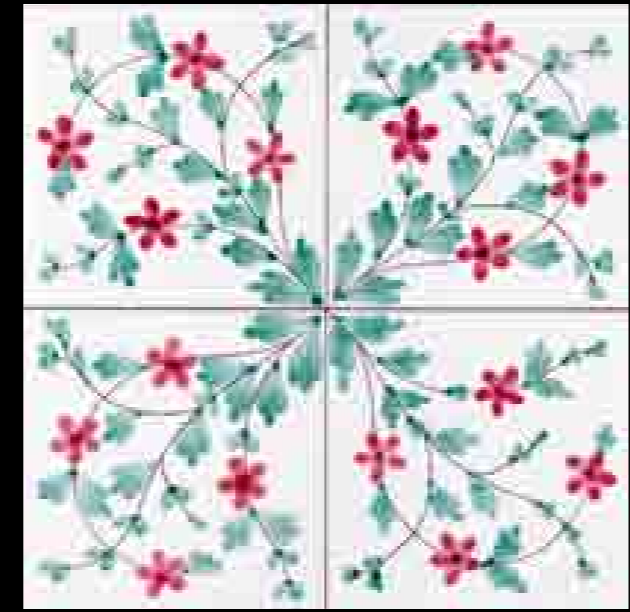

Scilla

Q128

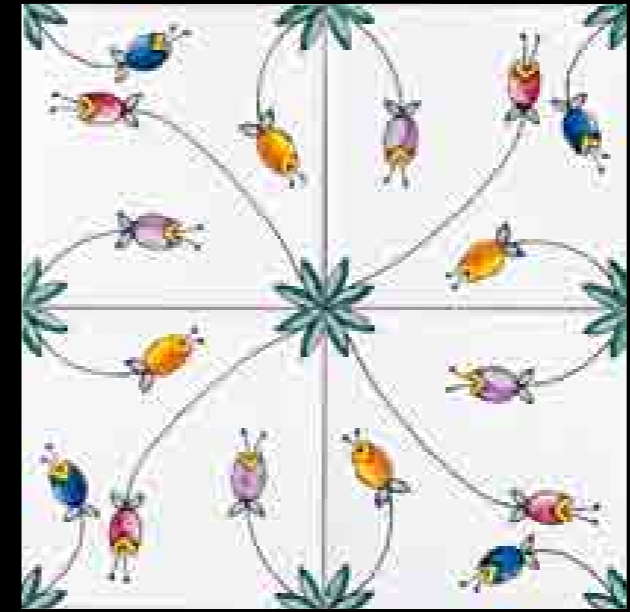

Tulipani

Q128



Still life della serie "I Giardini Vietresi" realizzato con diversi formati.



I Giardini Vietresi 20x20 8x8 inc.



Maria Cristina Rosa Antico Q128



Garofani Azzurro Q183



Rivestimento: "I Giardini Vietresi" Garofani Azzurro 20x20. Bianco Vietri 20x20. "I Pennelati" Azzurro 20x20. Listello Bombato Azzurro 3x20. Listello Sagomato Garofani Azzurro 10x20. Listello Garofani Azzurro 10x20
Pavimento: "I Giardini Vietresi" Garofani Azzurro 20x20. "I Pennelati" Azzurro 20x20.

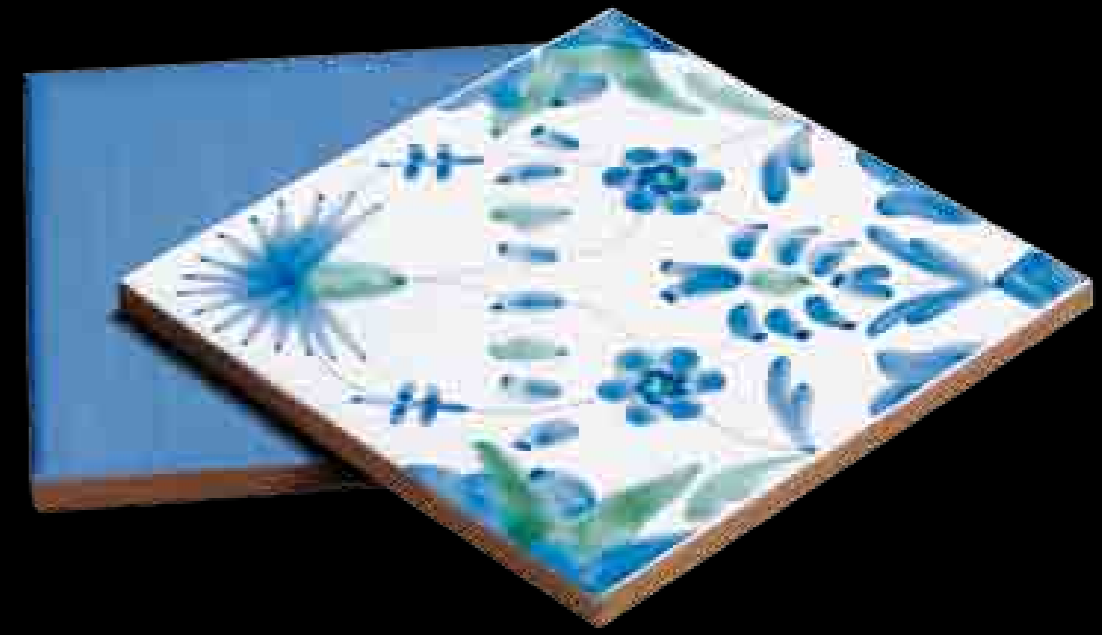

L'antica arte di preziosa materielle fatta a mano. The ancient art of fine handmade tiles.



I Classici 20x20 8x8 inc.

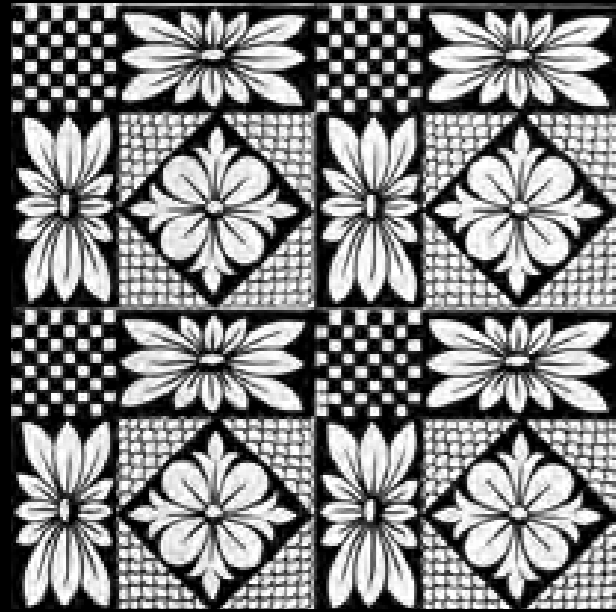

Dama Nero Q88



Vecchia Napoli Q128



Gotico Q148



Antica Napoli Q128



Nice Nero Q88

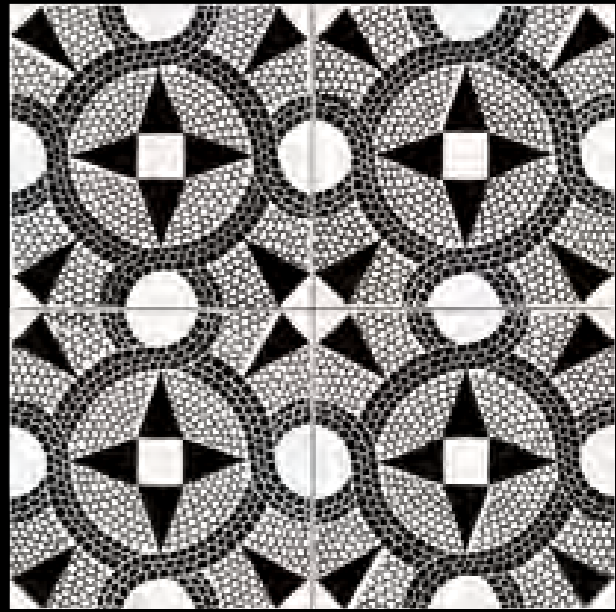

Romano Nero Q93



I Decori su Spugnato 20x20 8x8 inc.

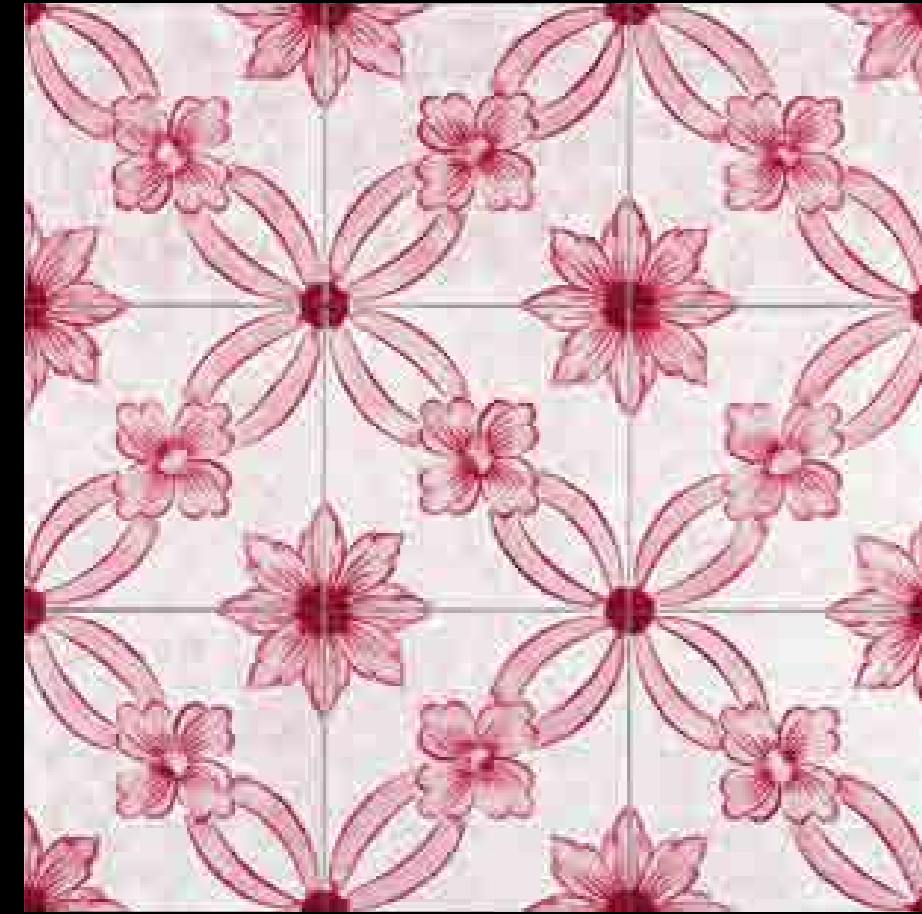

Forio Rosso

Q148

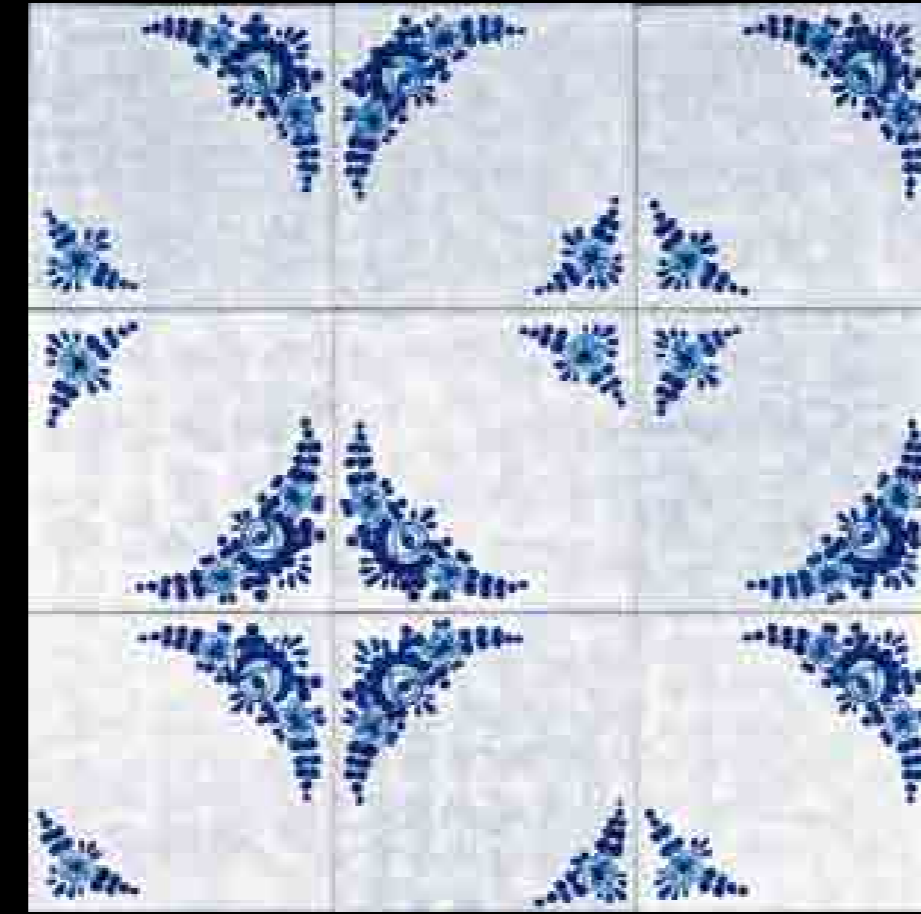

Roseto Blu

Q148



Anacapri Blu

Q148



Casamicciola Verde Rame

Q148

L'antica arte di preziosa materielle fatta a mano. The ancient art of fine handmade tiles.

Mediterranea 20x20 8x8 inc.



Crociato Blu Q128



Levante Q128



Quercia Verde Rame Q128



Still life della serie "Mediterranea" realizzato con diversi formati.

Mediterranea 20x20 8x8 inc.

L'antica arte di preziosa materielle fatta a mano. The ancient art of fine handmade tiles.



Gea Turchese

Q183



Amalfi

Q183



Rivestimento: "Mediterranea" Amalfi 20x20. "I Pennellati" Giallo 10x10. Torello Pennellato Giallo 10x10. Listello Amalfi 10x20.
Terminale Rivestimento 5x20 Torcello Giallo
Pavimento: "Mediterranea" Amalfi 20x20.

Mediterranea 20x20 8x8 inc.



Vitula Blu Q128



Sorrento Q128



Barocchetto Q193

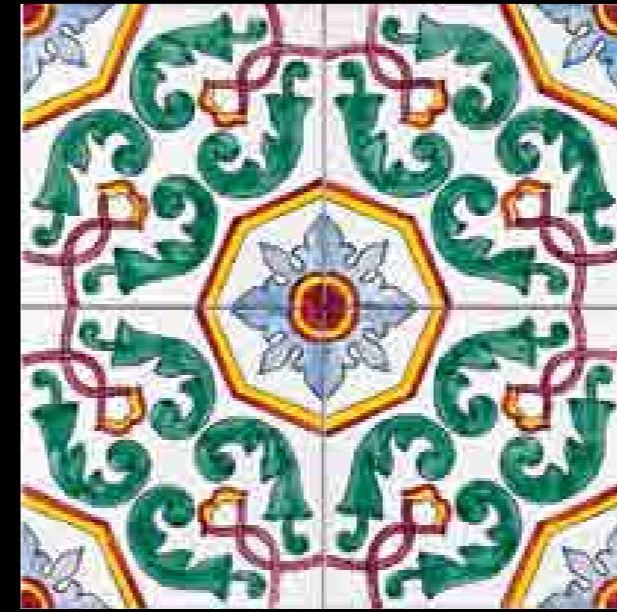

Assisi Q128



Vesuvio Q128

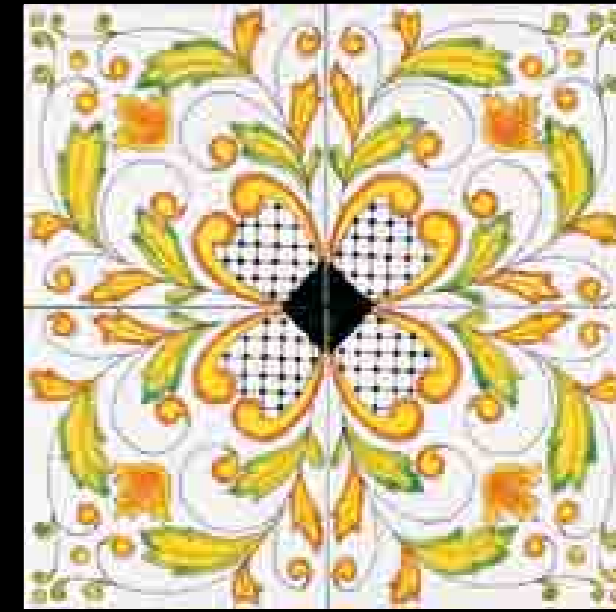

Samo Q128

L'antica arte di preziose mattonelle fatte a mano. The ancient art of fine handmade tiles.

Mediterranea 20x20 8x8 inc.

L'antica arte di preziosa materielle fatta a mano. The ancient art of fine handmade tiles.



Cerchio Annachiara Q148



Pigne Turchese Q128

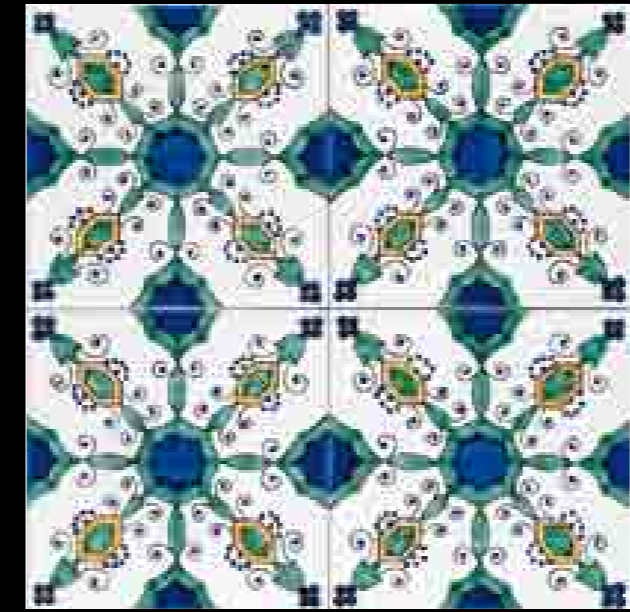

Ventotene Q128



Appia Q148



Barocco Cerchio Rosso Q193

Rivestimento: Listello Appia 10x20. "I Pennelati" Blu 10x10. Bianco Vietri 10x10. Bianco Vietri 20x20. Torello Blu 10x10. Torello Bianco Vietri 10x10. Torcello "I Pennelati" Blu 5x20.
Pavimento: "Mediterranea" Appia 20x20.

Mediterranea 20x20 8x8 inc.



Turco Q308

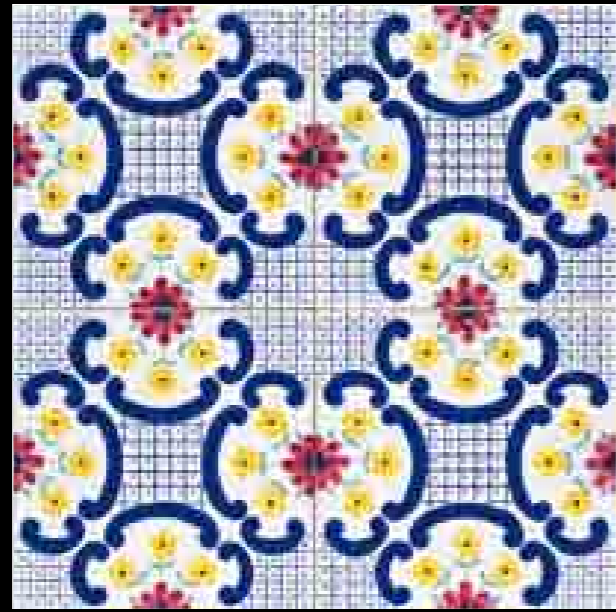

Cetara Q148



Aurora Q148

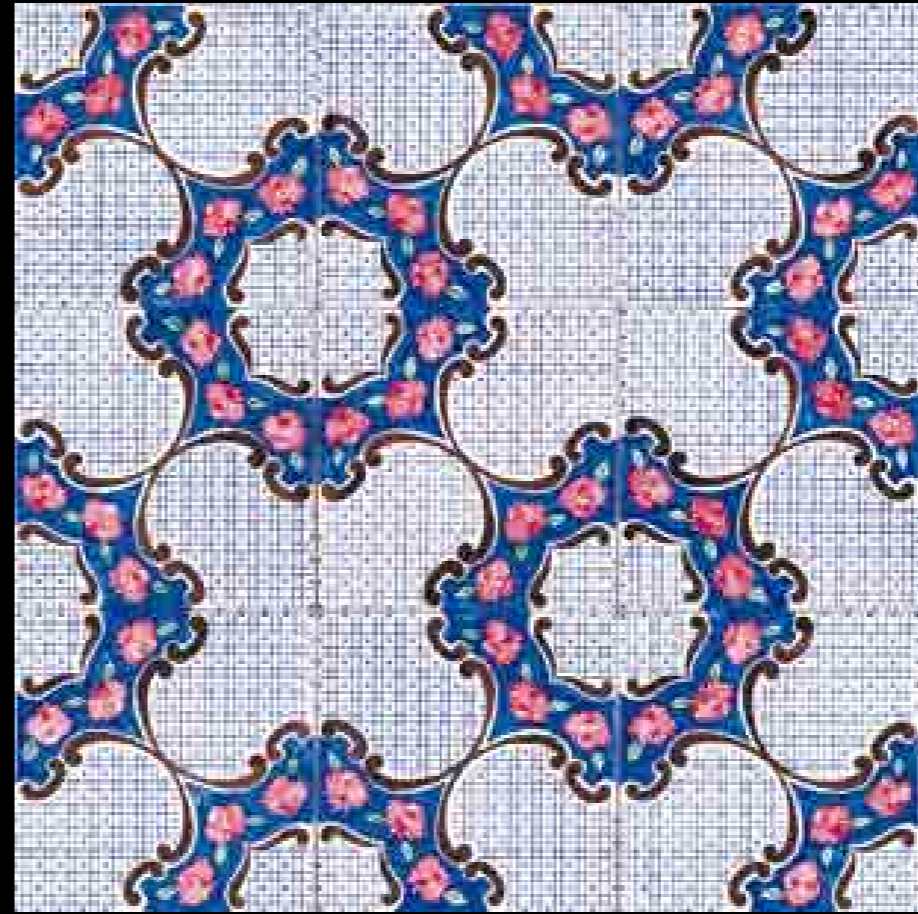

Erchie Q183



Lecce Q183

L'antica arte di preziose mattonelle fatte a mano. The ancient art of fine handmade tiles.

Mediterranea 20x20 8x8 inc.

L'antica arte di preziosa mattonelle fatte a mano. The ancient art of fine handmade tiles.



Linda

Q128



Barocco Rosso e Blu

Q218



Viareggio

Q228



Maria Teresa

Q128



Mediterranea 20x20 8x8 inc.

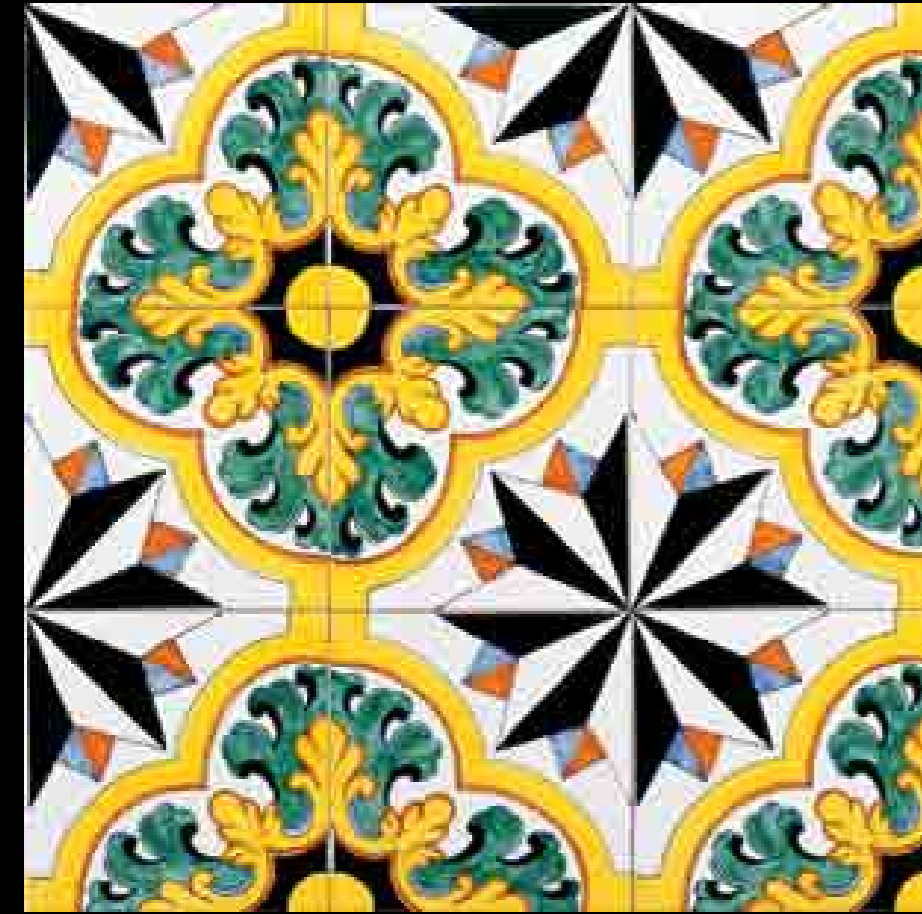

Capodimonte

Q183



Pavimento: "Mediterranea" Capodimonte 20x20.



Santa Lucia

Q128



Pavimento: "Mediterranea" Santa Lucia 20x20 - Grand Hotel Villa Soglia Castel San Giorgio (Salerno)

Mediterranea 20x20 8x8 inc.

L'antica arte di preziose mattonelle fatte a mano. The ancient art of fine handmade tiles.



Camaldoli

Q183



Fiore Antico

Q188

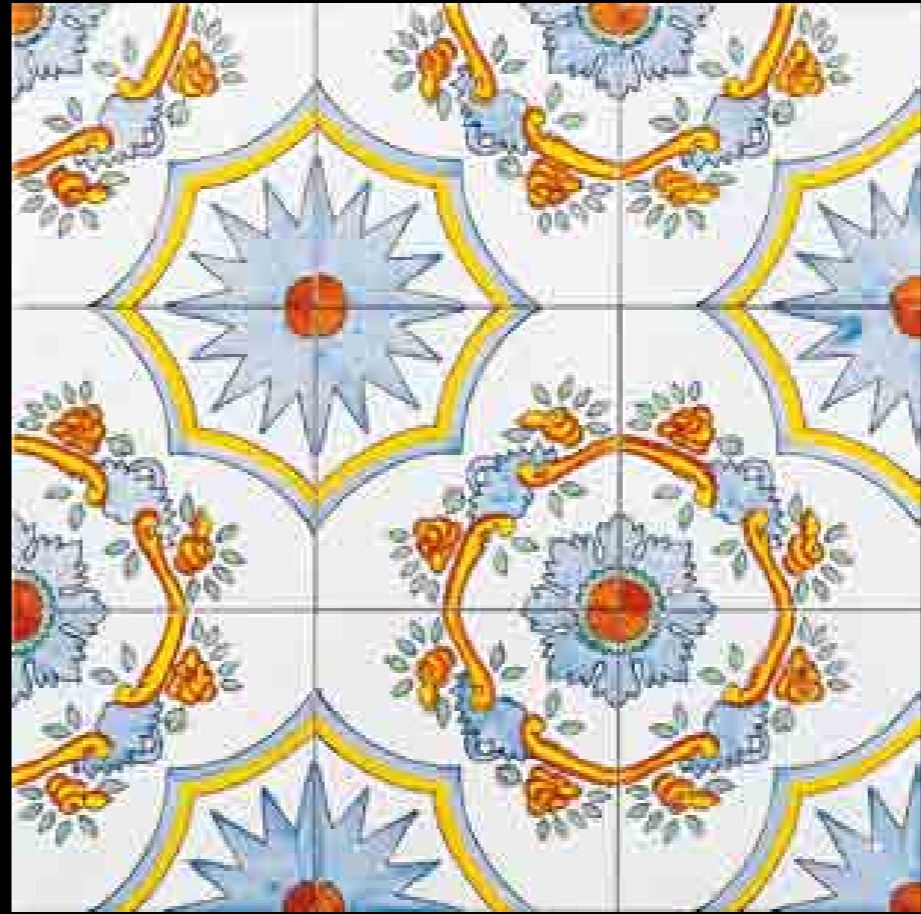

Valeria

Q128



Siepe

Q128

Mediterranea 20x20 8x8 inc.

L'antica arte di preziosa materielle fatta a mano. The ancient art of fine handmade tiles.



Settecento

Q183



Gloria

Q128



Pavimento: "Mediterranea" Gloria 20x20.
Grand Hotel Villa Soglia Castel San Giorgio (Salerno)



20x20 8x8 inc. I Festoni

Tutti i decori possono essere realizzati in versione di colore differenti da quelli proposti, utilizzando per la scelta la gamma dei colori pennellati. Su richiesta è possibile la realizzazione di altri decori.

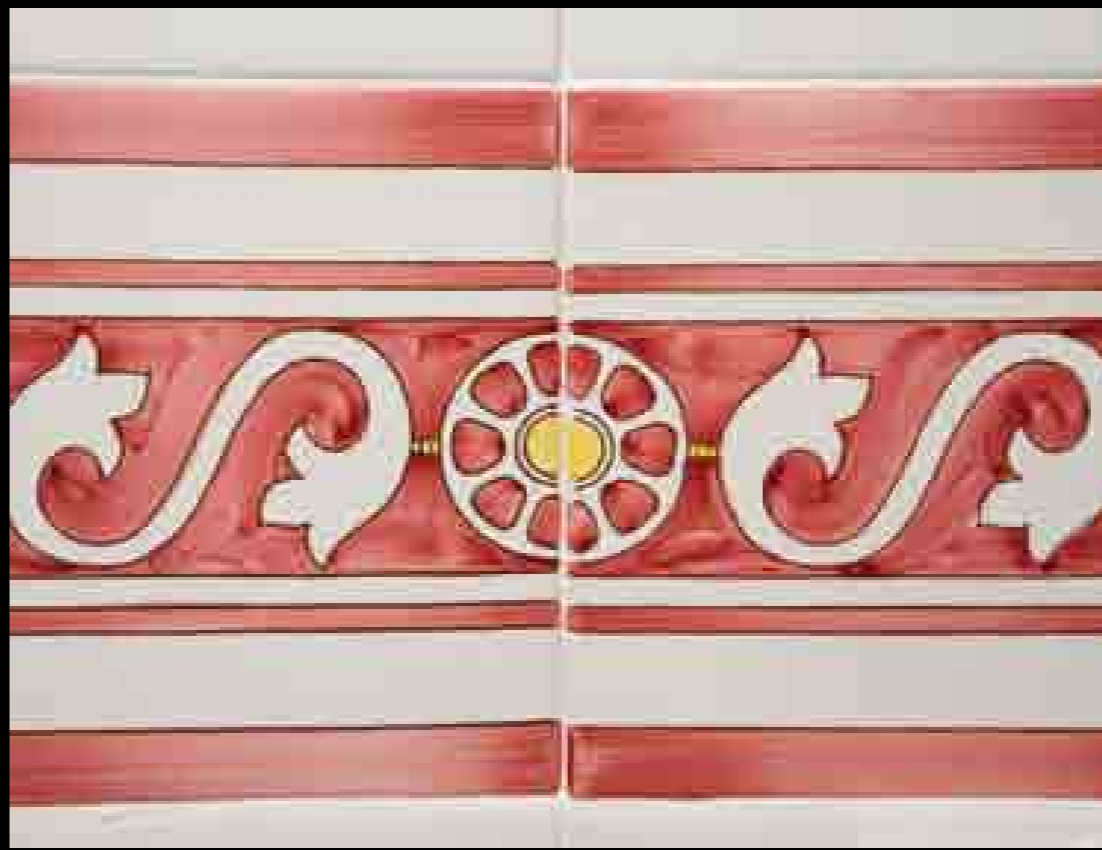

All the decorations can be created in different colours from the ones proposed, choosing amongst the range of Pennellati colours. It is possible to create other decorations on demand.



I Festoni 20x20 8x8 inc.

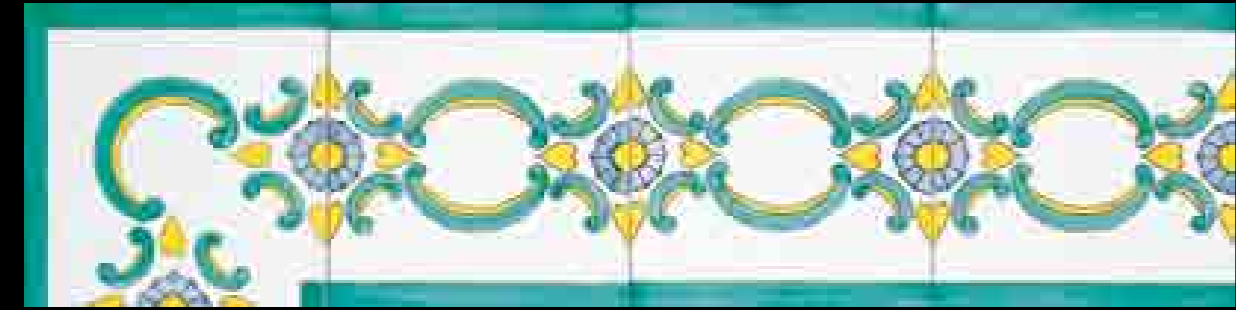

Verona Verde Nilo

L65

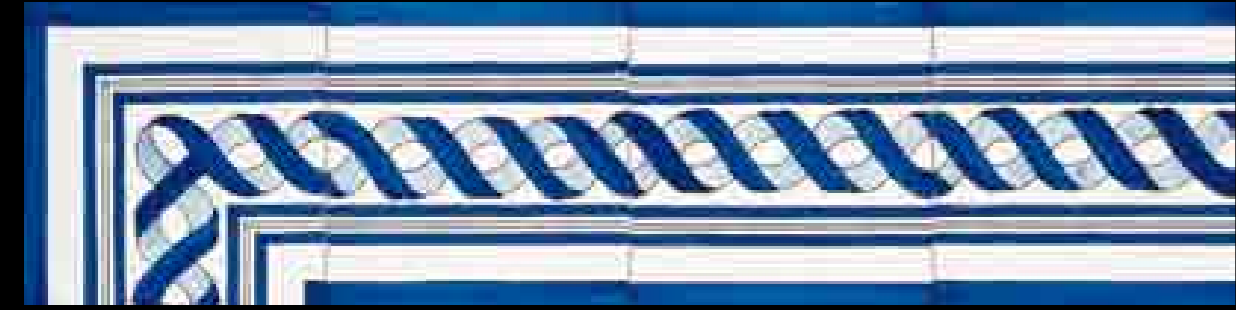

Aurelia

L65

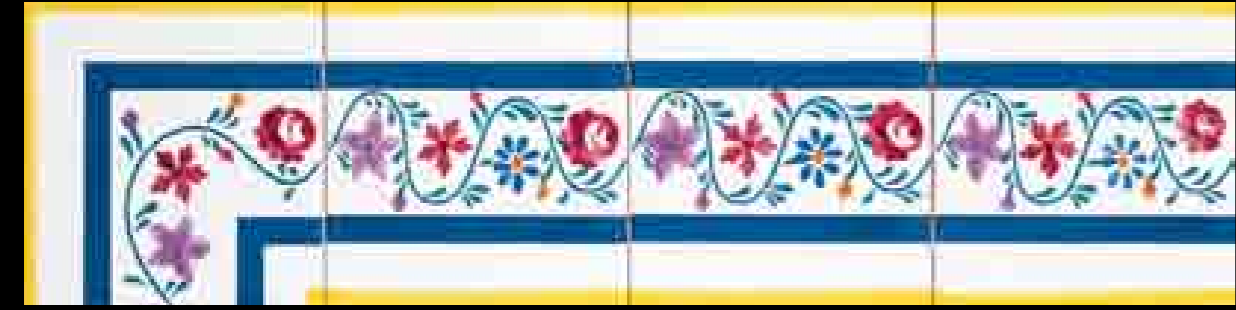

Valentina

L65



Still life della serie "Festoni" realizzato con diversi formati.



I Festoni 20x20 8x8 inc.

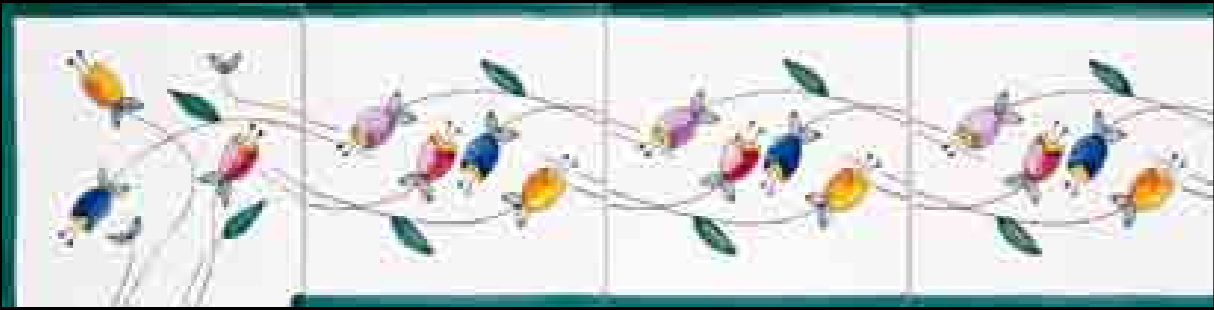

Greca Tulipani L65

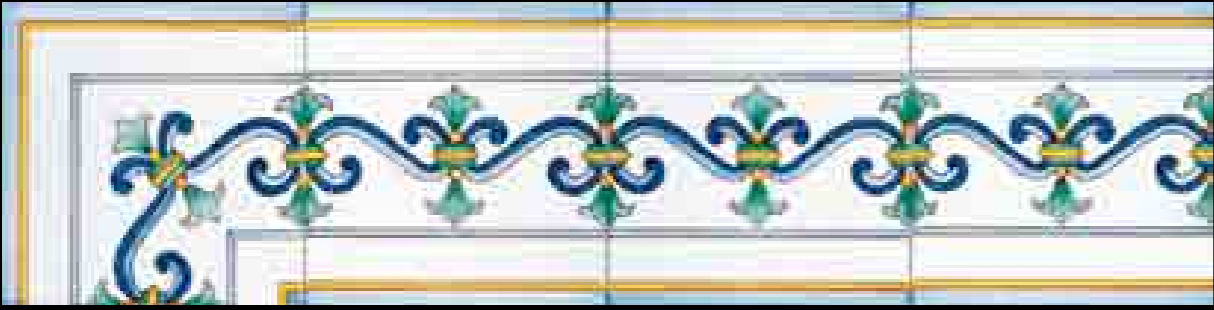

Priscilla L65

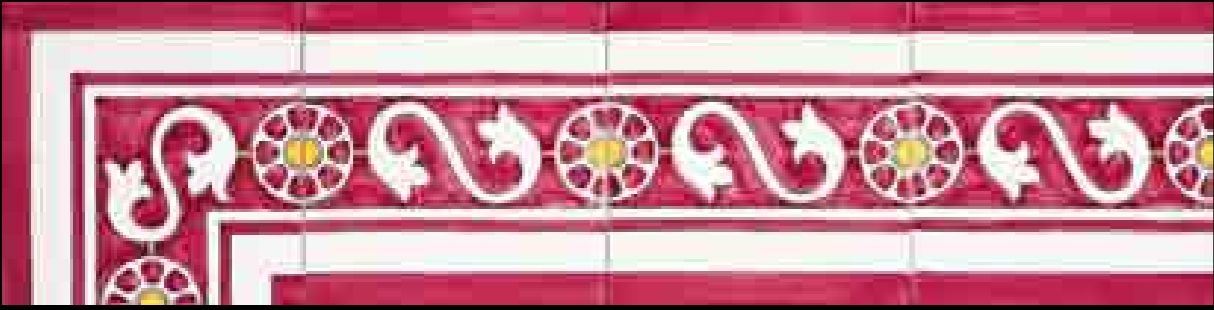

Pompeiana Rosso L65



Rivestimento: "I Festoni" Pompeiana Rosso 20x20. Bianco Vietri 20x20.

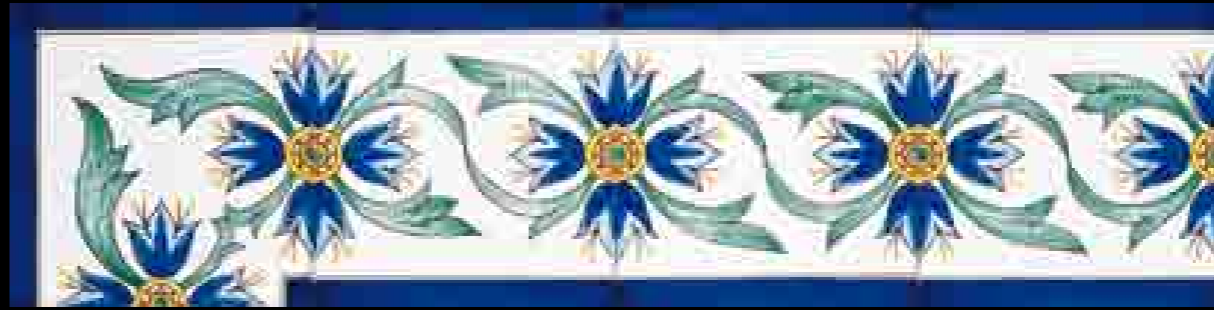

Alessandra L65

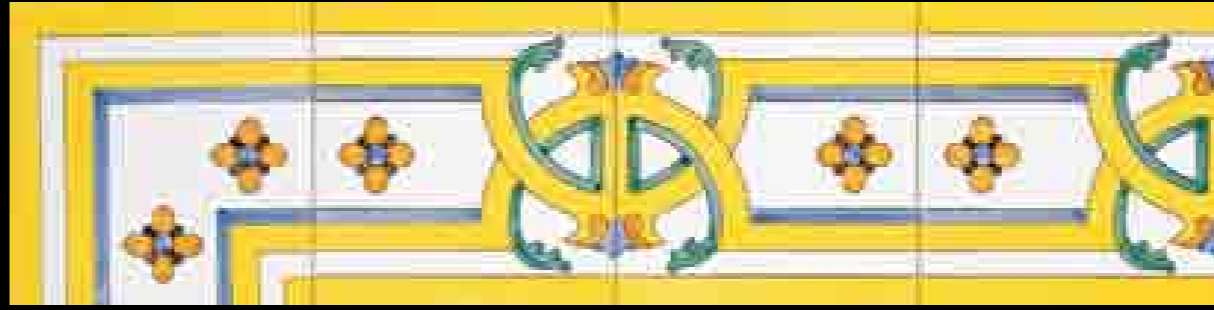

Germana L65

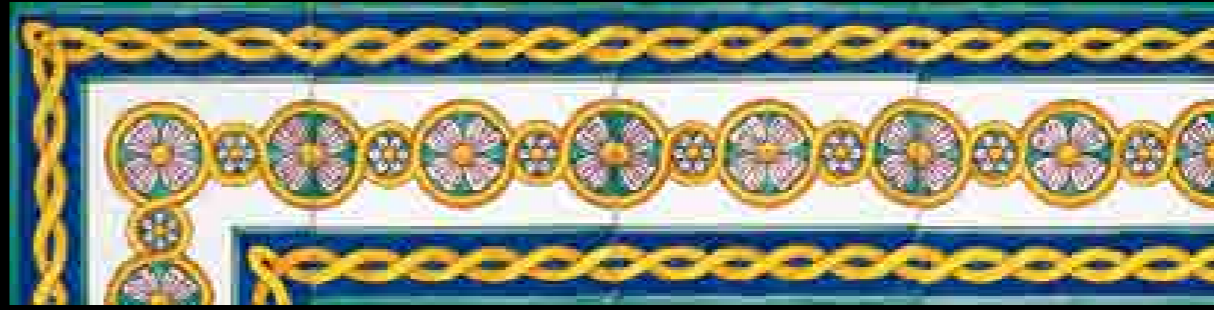

Angelica L65



Rivestimento: "I Festoni" Angelica 20x20. Bianco Vietri 20x20. Listello Angelica 5x20. Rivestimento 10x10 Torello Bianco. Bianco Vietri 10x10. Listello Angelica 10x20. Pavimento: Bianco Vietri 20x20. Listello Angelica 20x20.

L'antica arte di preziosa materielle fatta a mano. The ancient art of fine handmade tiles.

I Festoni 20x20 8x8 inc.

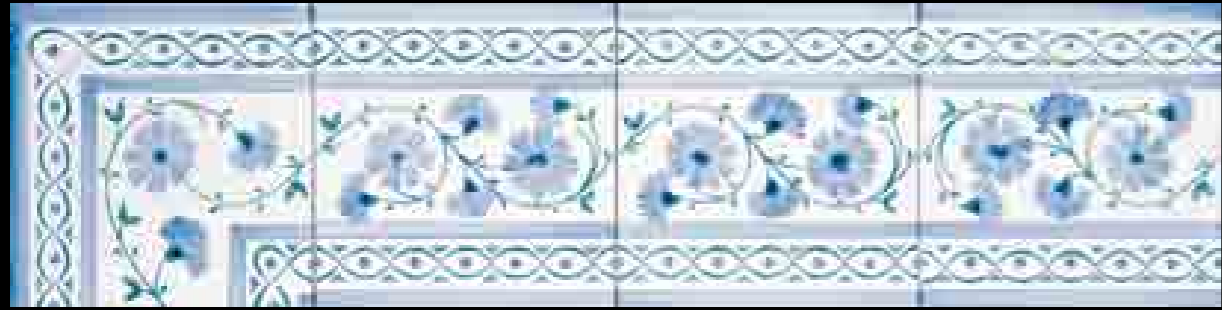

Lulù Azzurro

L65

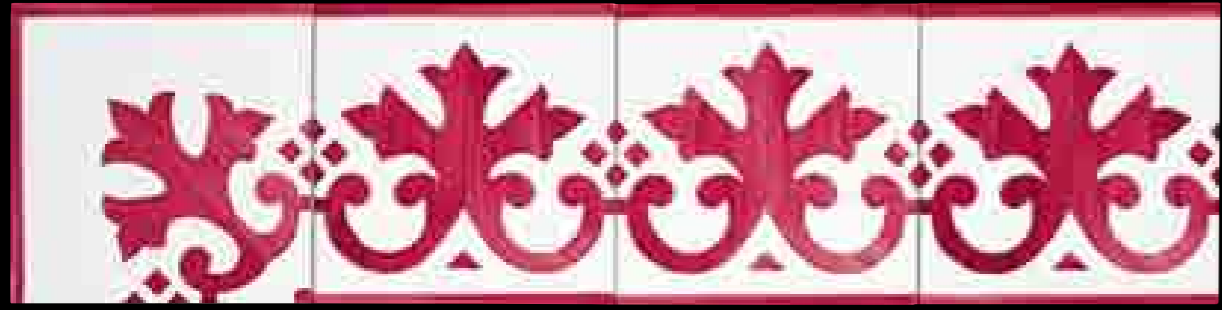

Ercolano Rosso

L65



Iside

L65

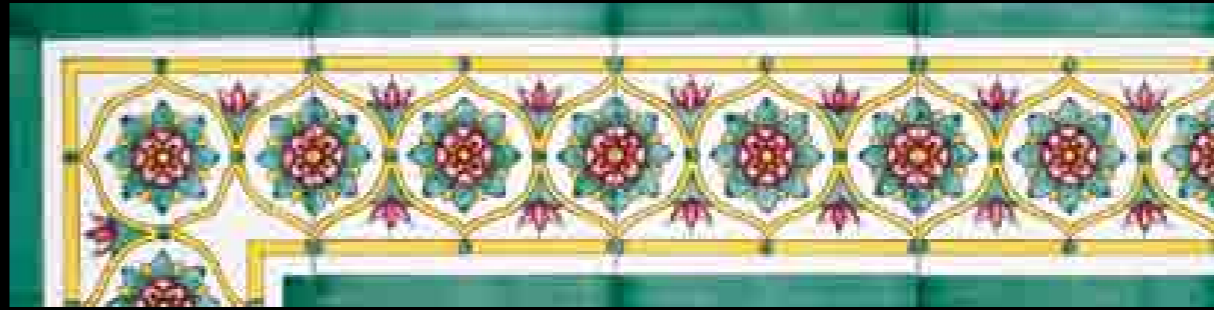

Verdiana

L65

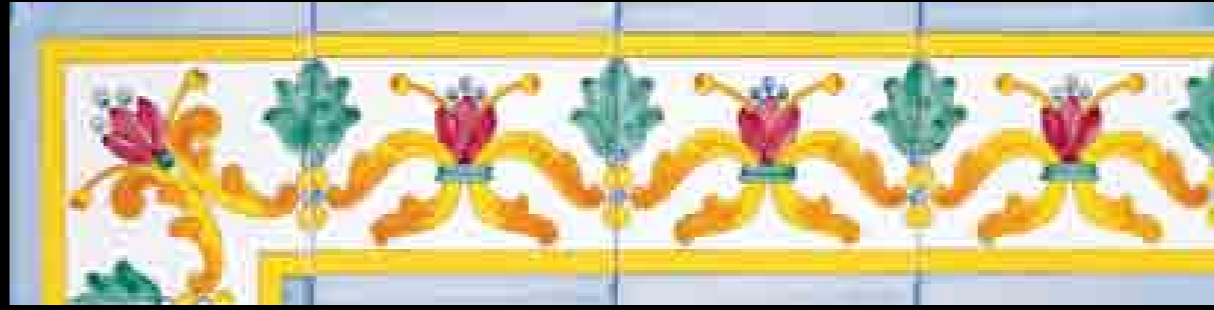

Raito

L65

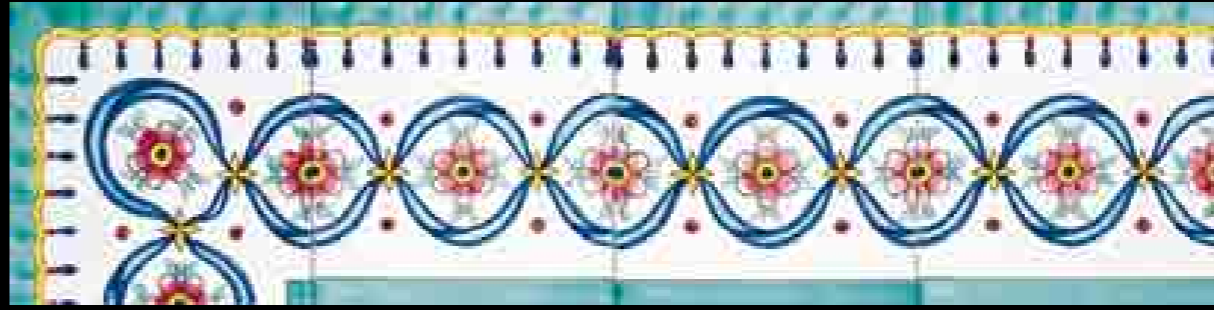

Fiorella

L65



L'antica arte di preziose mattonelle fatte a mano. The ancient art of fine handmade tiles.

I Festoni 20x20 8x8 inc.

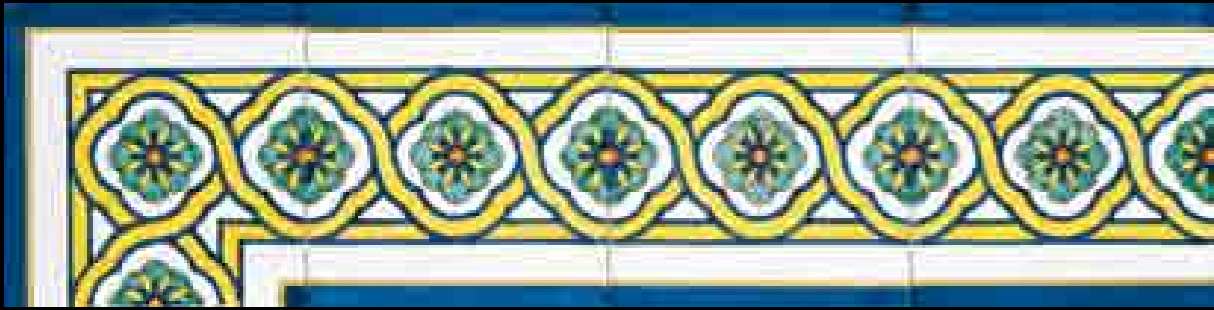

Federica

L65



Monica

L65



Flavia

L65



Rivestimento: "I Festoni" Angelica 20x20. Bianco Vietri 20x20. "I Pennellati" Verde Rame 10x20. Torcello "I Pennellati" Verde Rame 5x20.



Annachiara Blu

L65



Minori

L65



L'antica arte di preziosa materielle fatta a mano. The ancient art of fine handmade tiles.



l'antica arte di processare mattoni in pasta a mano. The ancient art of firing handmade tiles.

13x13 5x5 inc.

Tutti i decori possono essere realizzati in versione di colore differenti da quelli proposti, utilizzando per la scelta la gamma dei colori pennellati. Su richiesta è possibile la realizzazione di altri decori.



All the decorations can be created in different colours from the ones proposed, choosing amongst the range of Pennellati colours. It is possible to create other decorations on demand.



I Decori 13x13 5x5 inc.

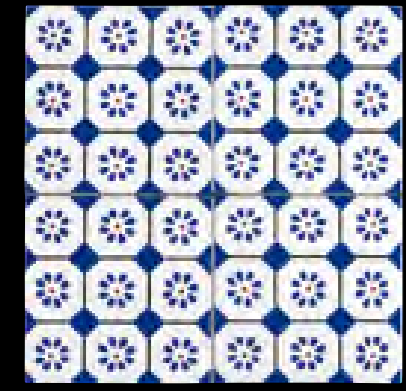

San Rocco Blu Q80

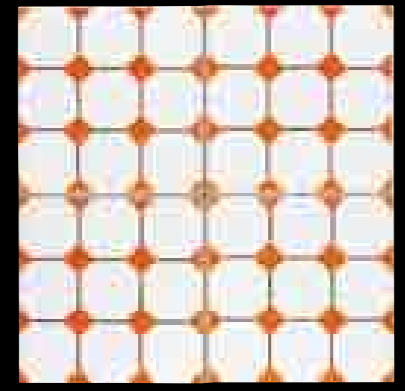

San Rocco S/P Arancio Q78

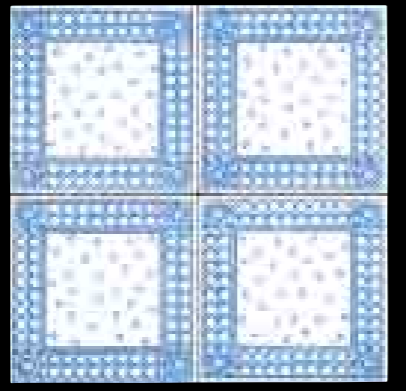

Pavus Blu Q78

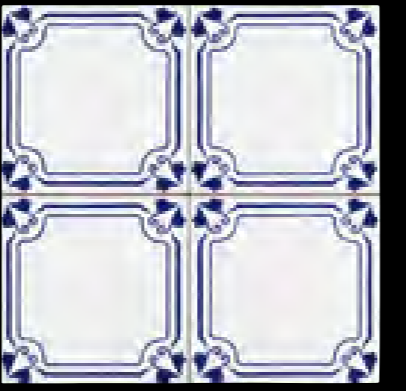

Eva Blu Q72

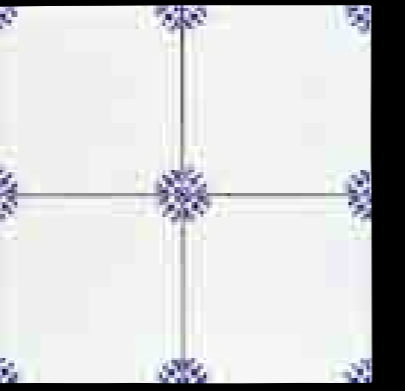

Angoli Rosetta Blu Q72

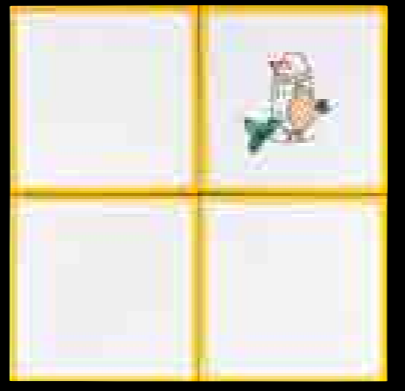

Bordino Giallo Q92

Bordino Giallo con Cocca Z24

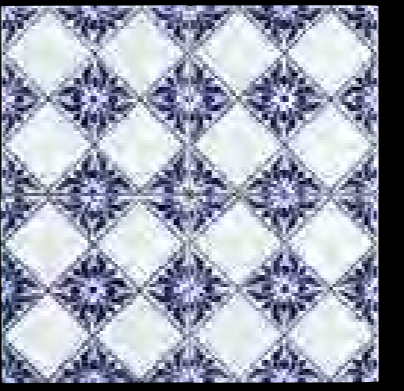

Antonella Blu Q72



Spigoli Bicolore Rosa e Grigio Q80



Spigoli Blu Q78

Spigoli Blu Terminale Z17

Spigoli Blu Terminale Angolo Z17

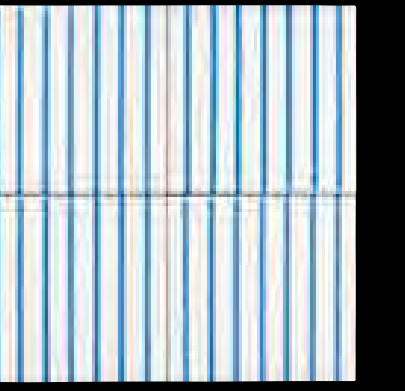

Linea 7 Azzurro Q72

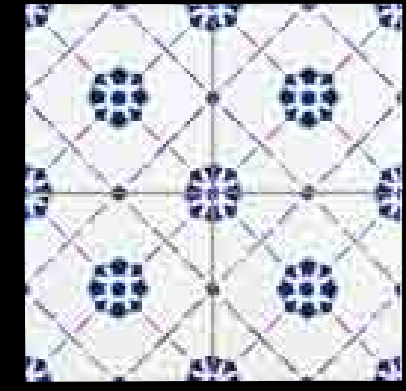

Gina Blu Q72



Costanza Blu Q88

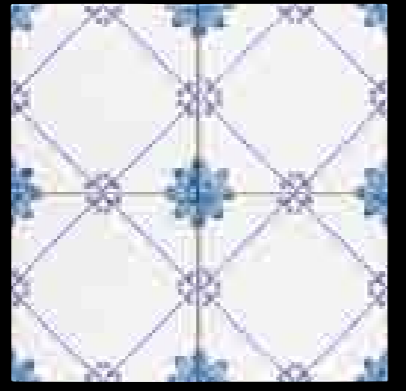

Sofia Azzurro Q88

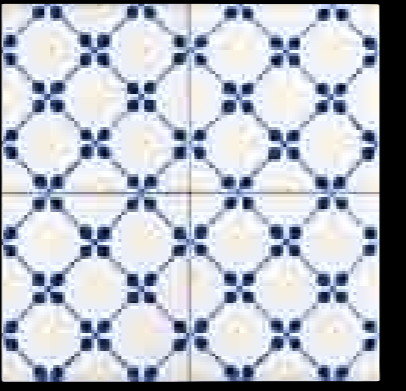

Palmettina Blu Q72

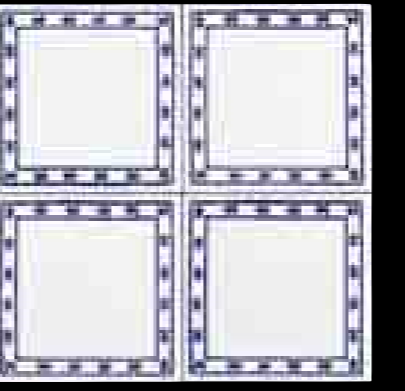

Giardino Blu Q72

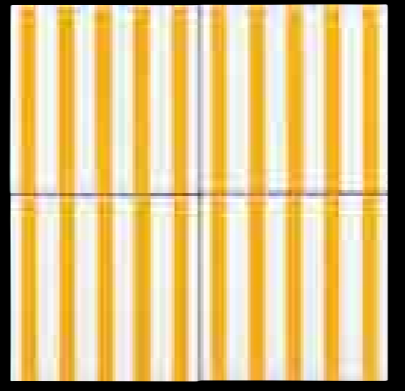

Linea 5 Giallo Arancio Q72

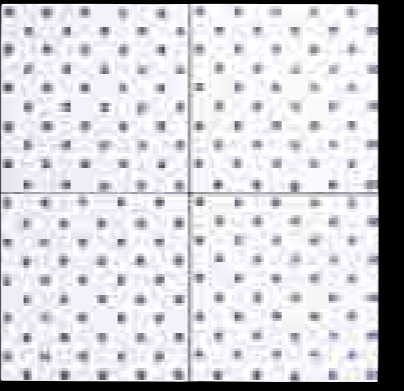

Amanda Blu Q72

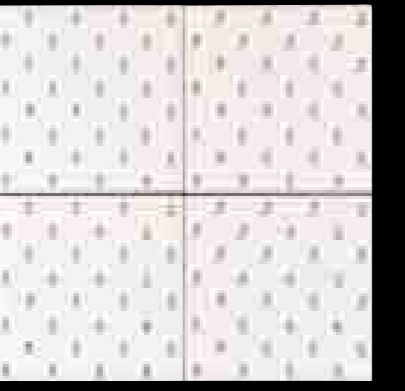

Grazia Rosso Q78



Gemme Rosa Q92

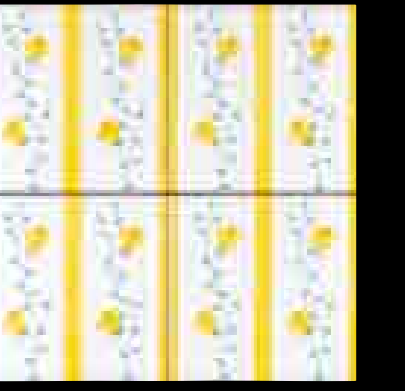

Domina Giallo Q92

L'antica arte di preziose mattonelle fatte a mano. The ancient art of fine handmade tiles.

I Decori 13x13 5x5 inc.

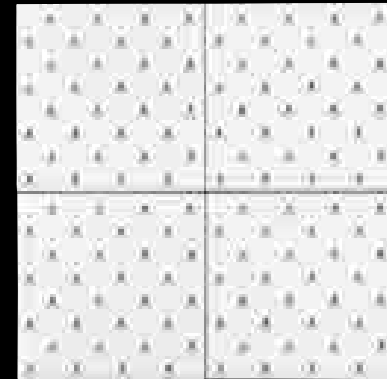

Gocce Blu Q78

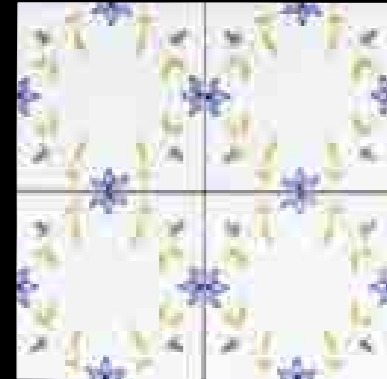

Alpina Blu Q92

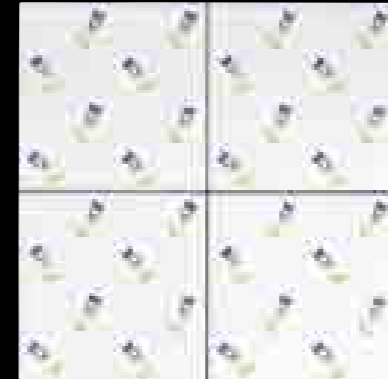

Fiordaliso Azzurro Q92

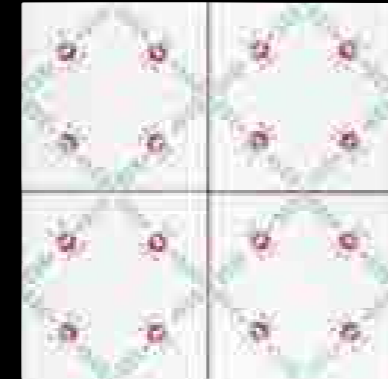

Martina Rosso Q92

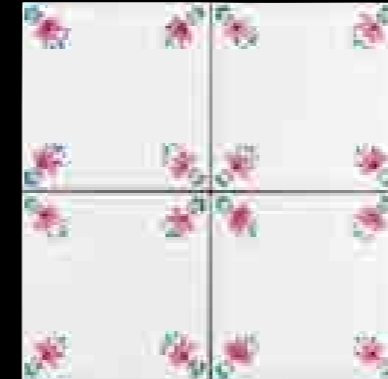

Liliana Rosa Q92

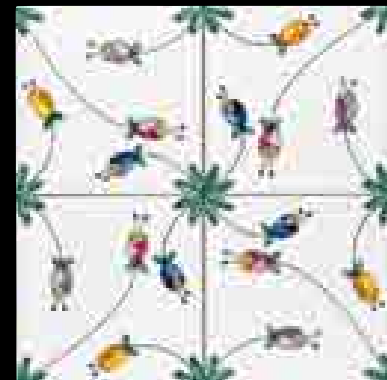

Tulipani Q143



Favignana Q143

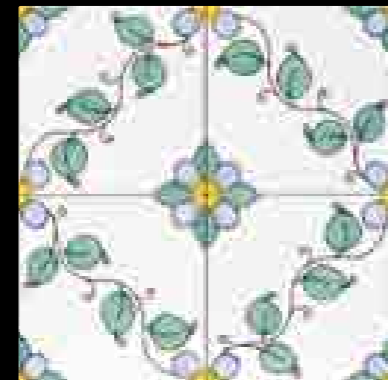

Leda Q143

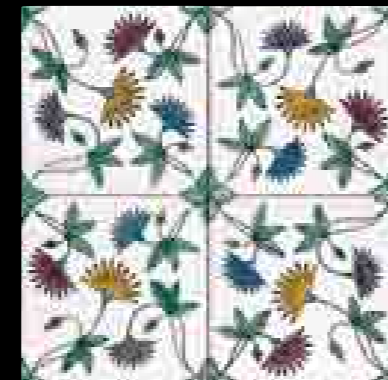

Clelia Q143

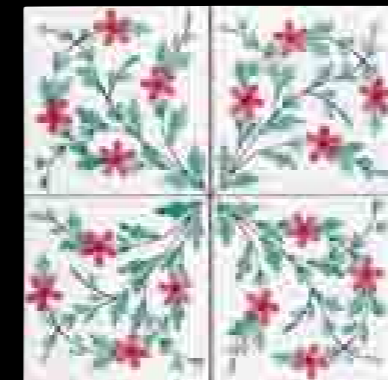

Scilla Q143

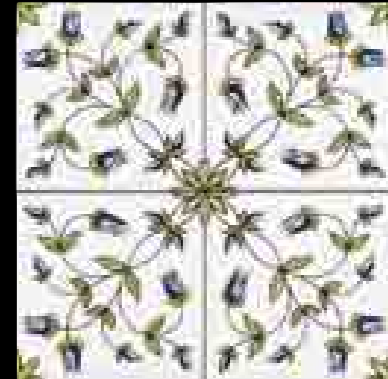

Gilda Blu Q143



Fiore Stilizzato Q143



Rivestimento: "I Decori" Fiore Stilizzato 13x13, Bianco Vietri 20x20, Torcello Verde Rame 5x13, Listello Fiore Stilizzato 6,5x26, "I Pennellati" Verde Rame 6,5x6,5.

I Decori 13x13 5x5 inc.

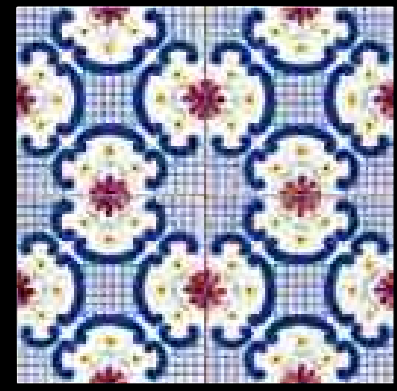

Cetara Q143



Caterina Rosa Q143

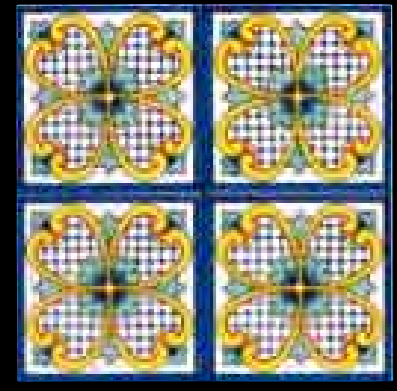

Ischia Q143

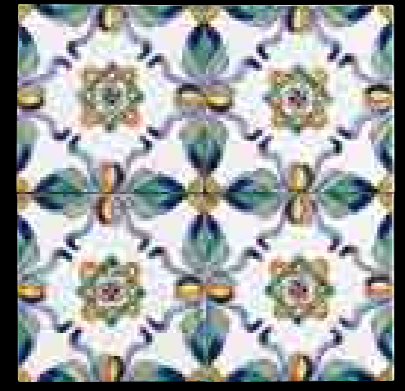

Vesuvio Q143



Rivestimento: "I Decori" Caterina Rosa 13x13. Bianco Vietri 13x13. "I Pennellati" Rosa 6,5x26. Torcello Rosa 6x13. Listello Caterina Rosa 6,5x26. "I Pennellati" Rosa 13x13. Pavimento: "I Decori" Caterina Rosa 13x13.



Maria Teresa Q143



Gloria Q163



Puteoli Q143



Linda Q163



I Festoni 13x13 5x5 inc.



Alessandra Z26



Germana Z26

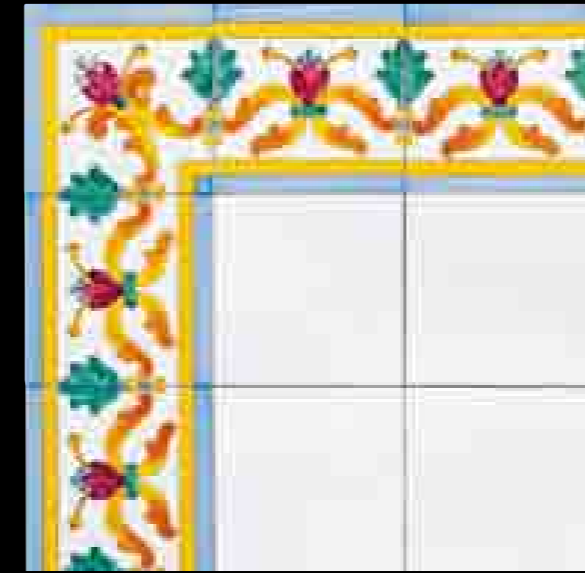

Raito Z26

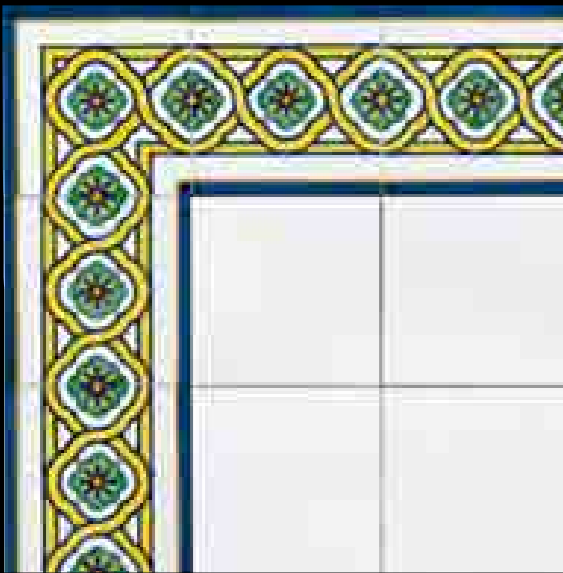

Federica Z26



Aurelia Z26

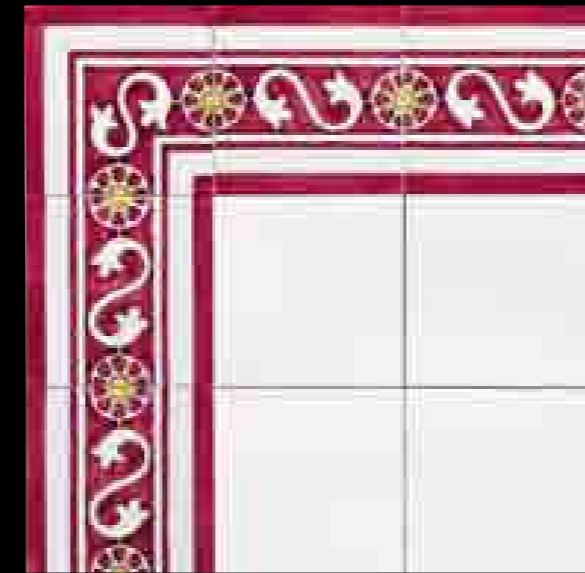

Pompeiana Rosso Z26

Rivestimento: "I Festoni" Alessandra 13x13. "I Pennellati" Blu 13x13. "I Pennellati" Verde Rame 13x13. Torcello Blu 5x13. Torcello Verde Rame 5x13. Listello Bombato Verde Rame 3x13.
Pavimento: "I Festoni" Alessandra 13x13. "I Pennellati" Verde Rame 13x13. "I Pennellati" Blu 13x13.



Flavia Z26

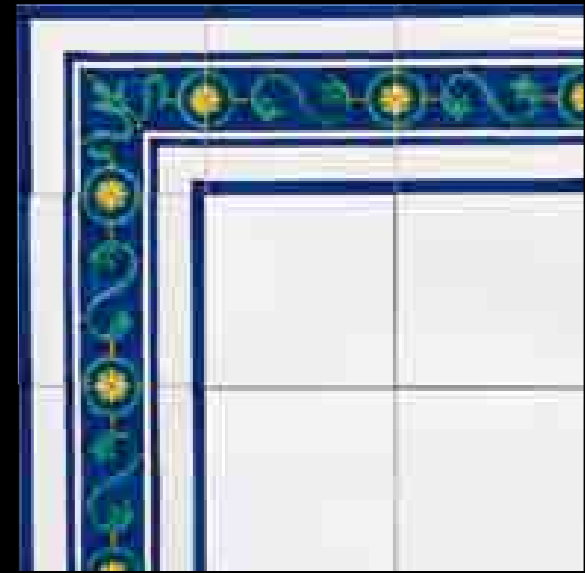

Annachiara Blu Z26



Minori Z26

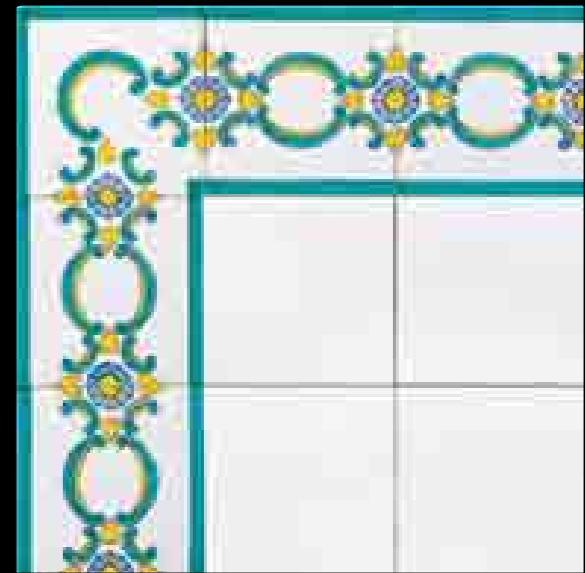

Verona Verde Nilo Z26

L'antica arte di preziosa mattonelle fatte a mano. The ancient art of fine handmade tiles.

I Festoni 13x13 5x5 inc.



Fiorella Z26



Iside Z26

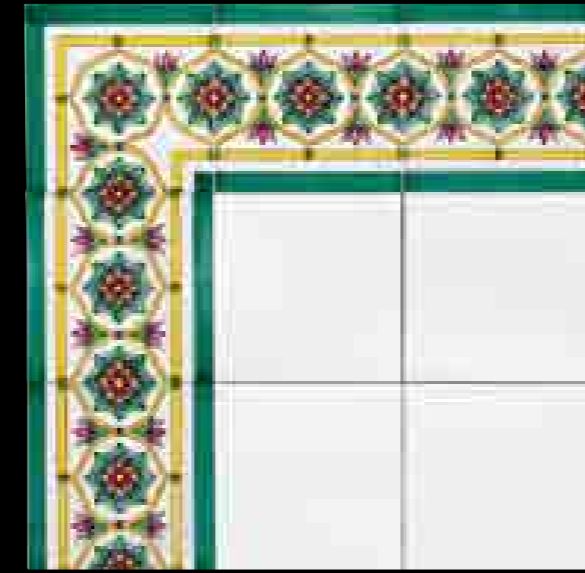

Verdiana Z26



Angelica Z26

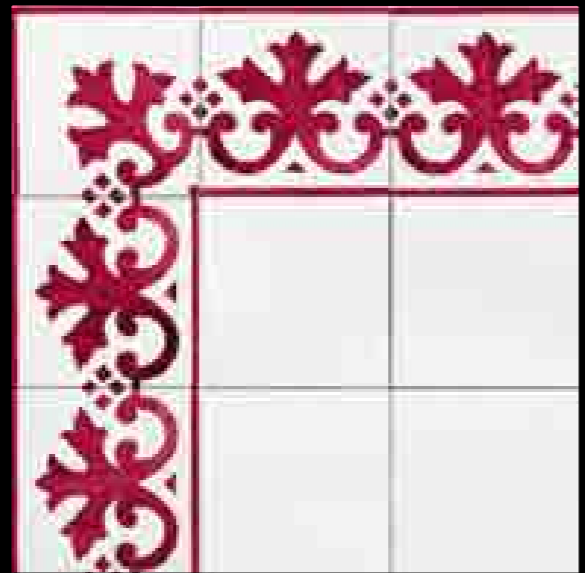

Ercolano Rosso Z26



Lullù Azzurro Z26



Rivestimento: "I Festoni" Fiorella 13x13. Bianco Vietri 13x13. "I Pennellati" Verde Nilo 13x13.
Torcello Verde Nilo 5x13. Listello Fiorella 6,5x26.
Pavimento: "I Pennellati" Verde Nilo 13x13.

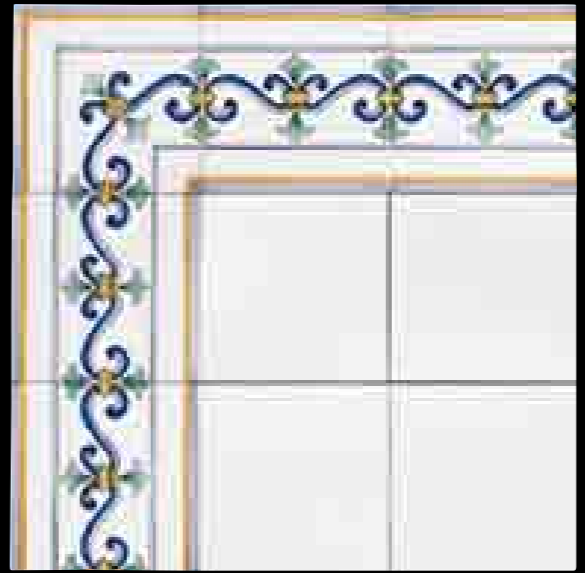

Priscilla Z26



Valentina Z26

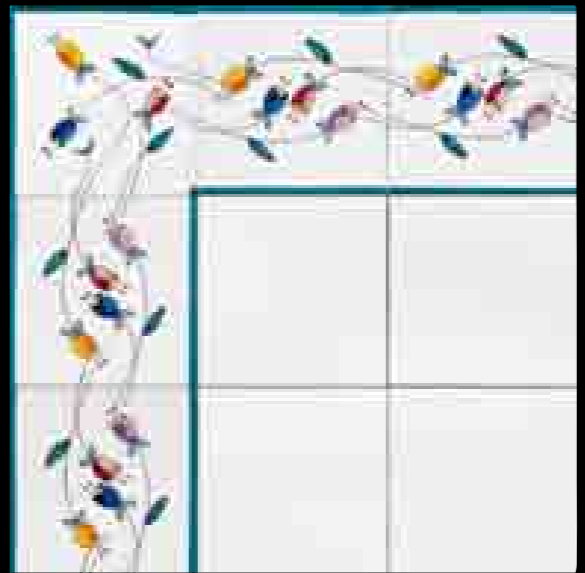

Greca Tulipani Z26



Monica Z26

L'antica arte di preziose mattonelle fatte a mano. The ancient art of fine handmade tiles.



10x10 4x4 inc.

Tutti i decori possono essere realizzati in versione di colore differenti da quelli proposti, utilizzando per la scelta la gamma dei colori pennellati. Su richiesta è possibile la realizzazione di altri decori.



All the decorations can be created in different colours from the ones proposed, choosing amongst the range of Pennellati colours. It is possible to create other decorations on demand.



I Decori 10x10 4x4 inc.



Decoro 1

Z19



Decoro 2

Z19

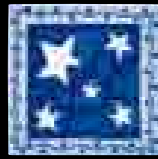

Decoro 3

Z19

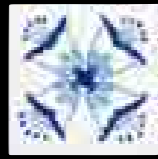

Decoro 4

Z19



Decoro 5

Z19



Decoro 6

Z19



Decoro 7

Z19



Decoro 8

Z19



Decoro 9

Z19



Decoro 10

Z19



Decoro 11

Z19



Decoro 12

Z19



Decoro 13

Z19



Decoro 14

Z19



Decoro 15

Z19

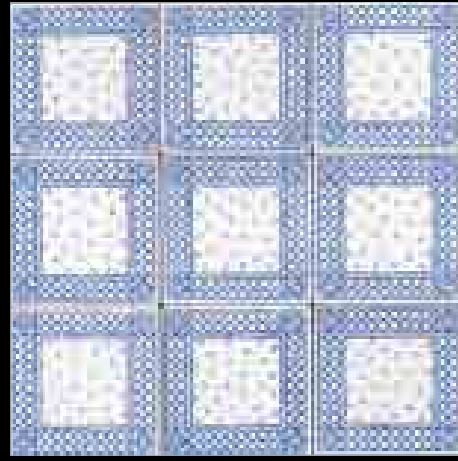

Pavus Blu

Q103

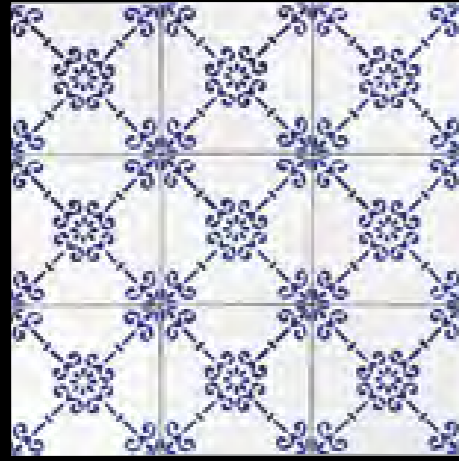

Brigida Blu

Q96

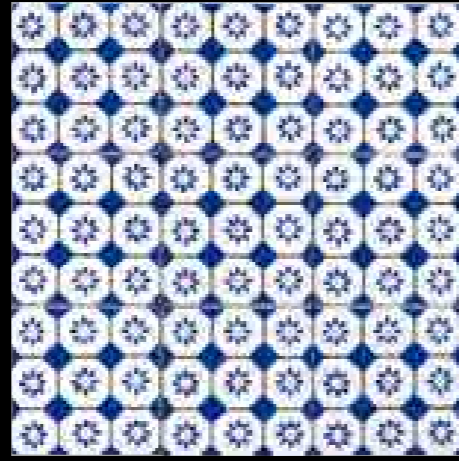

San Rocco Blu

Q113

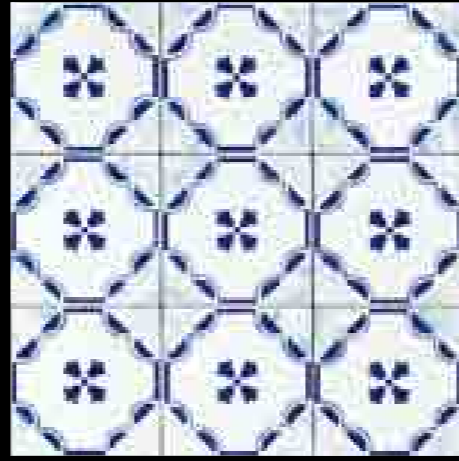

Nisida

Q113



Laura Blu

Q113



Laura Blu Terminale

Z19

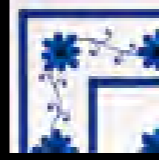

Laura Blu Terminale Angolo

Z19

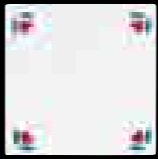

Simonetta Rosso

Q103



Simonetta Rosso Terminale

Z19



Simonetta Rosso Terminale Angolo

Z19

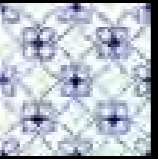

Milena Azzurro

Q103

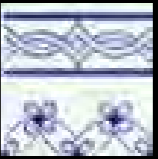

Milena Azzurro Terminale

Z19



Milena Azzurro Terminale Angolo

Z19

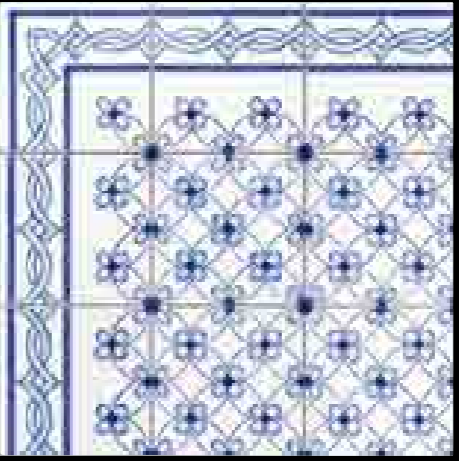
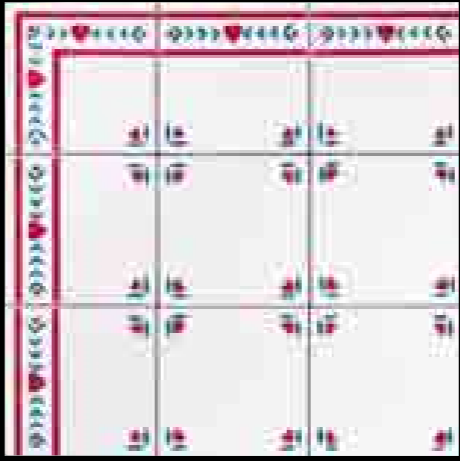
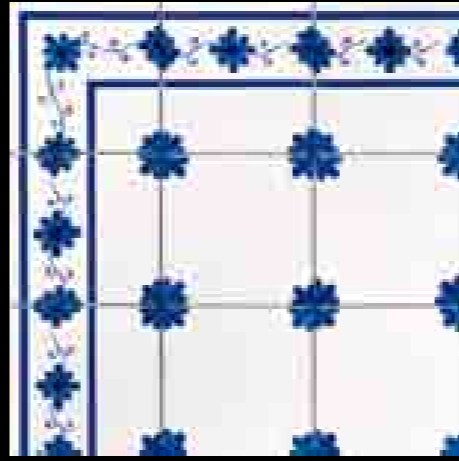

Rivestimento: Milena Azzurro 10x10. Milena Azzurro Terminale 10x10. Milena Azzurro Terminale Angolo 10x10. Bianco Vietri 10x10. "I Pennellati" Azzurro 10x10. Listello Milena Azzurro 5x20. Listello Bombato Blu 3x20. "I Pennellati" Azzurro 5x5. Torello Bianco Vietri.

Pavimento: Cotto La Raggiola 20x20



L'antica arte di preziose mattonelle fatte a mano. The ancient art of fine handmade tiles.

I Decori 10x10 4x4 inc.



Spigoli Blu
Q96



Spigoli Blu Terminale
Z19



Greca Pizzo Antico Blu
Q96



Pizzo Antico Blu
Z19



Angoli Rosetta Blu
Q96



Angoli Rosetta Blu Terminale
Z19



Amanda Blu
Q96

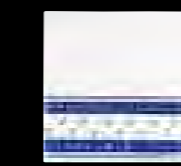

Amanda Blu Terminale
Z19

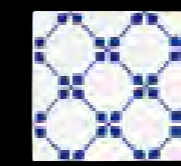

Palmettina Blu
Q96

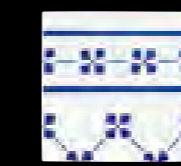

Palmettina Blu Terminale
Z19

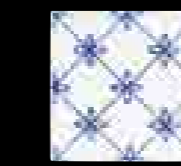

Lidia Azzurro
Q103



Lidia Azzurro Terminale
Z19



Fabiola
Q158



Fabiola con Fiore Centrale
Z19



Marilena Blu
Q103

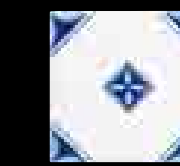

Marilena Blu con Decoro Centrale
Z19



Spigoli Blu Terminale Angolo
Z19

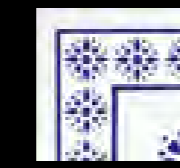

Angoli Rosetta Blu Terminale Angolo
Z19



Amanda Blu Terminale Angolo
Z19

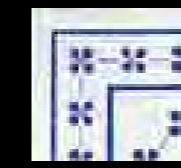

Palmettina Blu Terminale Angolo
Z19

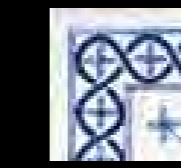

Lidia Azzurro Terminale Angolo
Z19



Marilena Blu Terminale
Z19



Marilena Blu Terminale Angolo
Z19

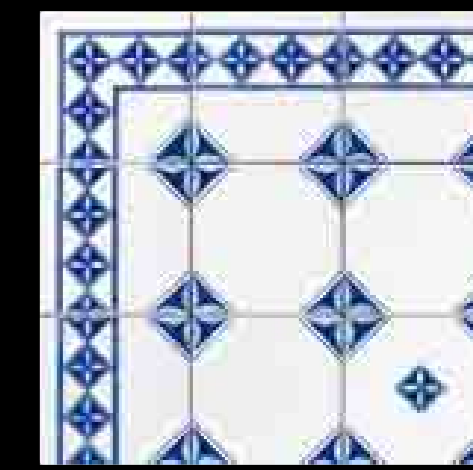
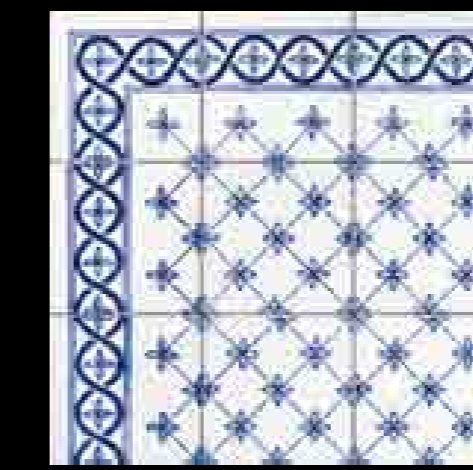
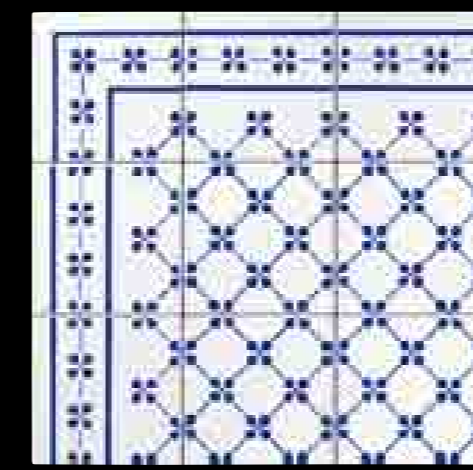
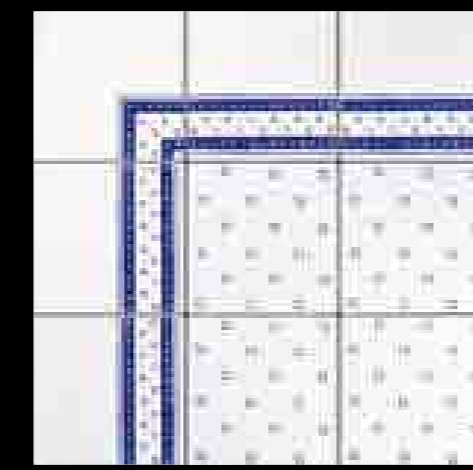
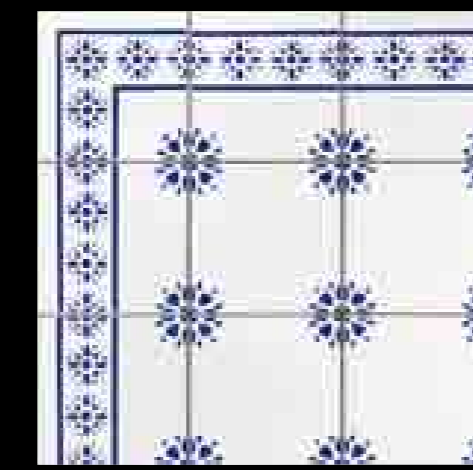
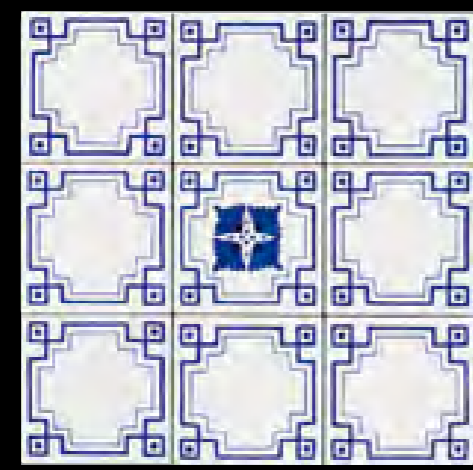
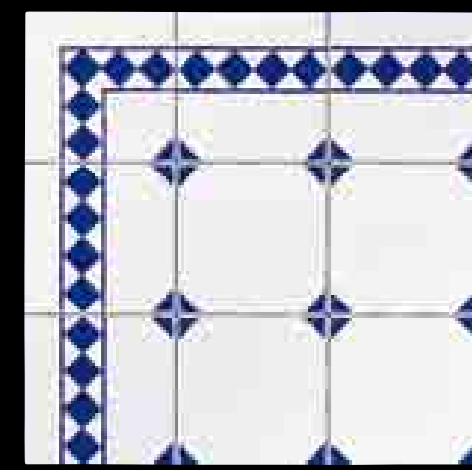

L'antica arte di preziosa mattonelle fatta a mano. The ancient art of fine handmade tiles.

L'antica arte di preziose mattonelle fatte a mano. The ancient art of fine handmade tiles.

I Decorati 10x10 4x4 inc.



Rosalia con Fiore
Z19



Rosalia
Q158

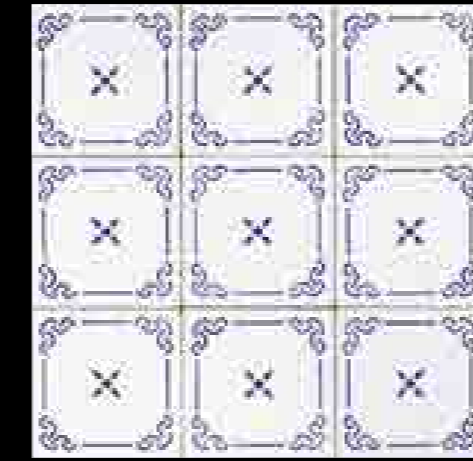
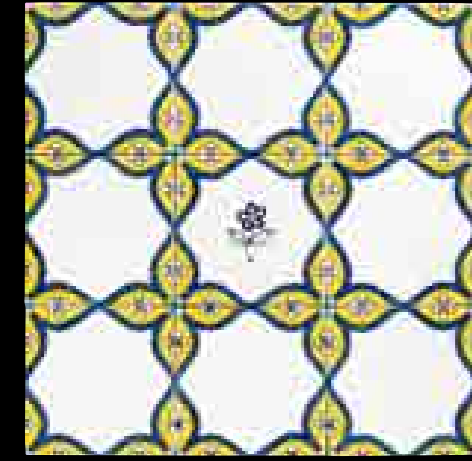

Sannini Blu
Q96

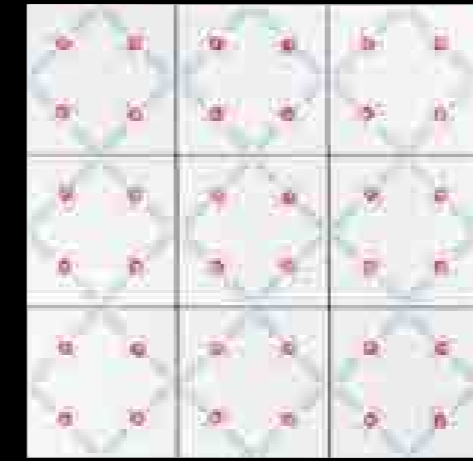

Martina Rosso
Q113

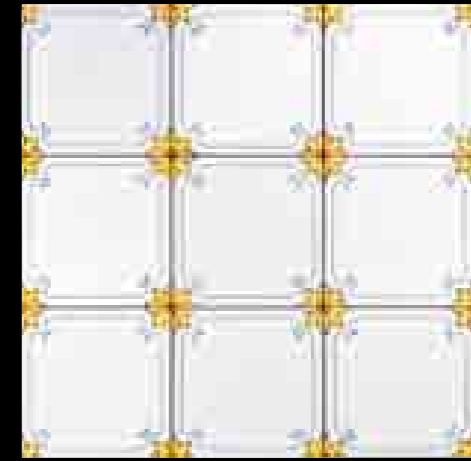

Camilla Giallo
Q113

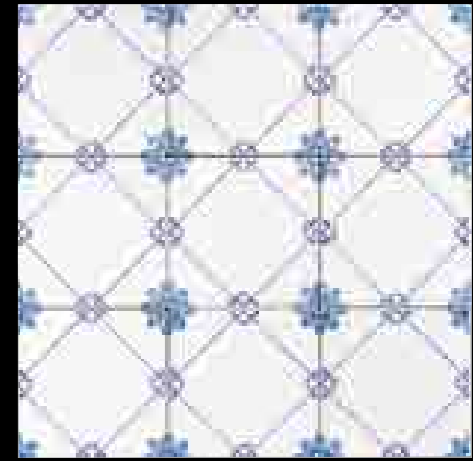

Sofia Azzurro
Q113

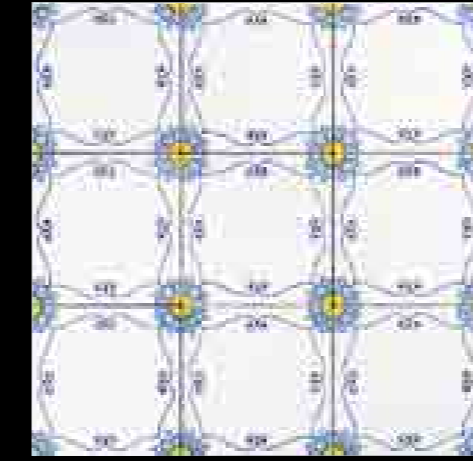

Ludovica Azzurro
Q113

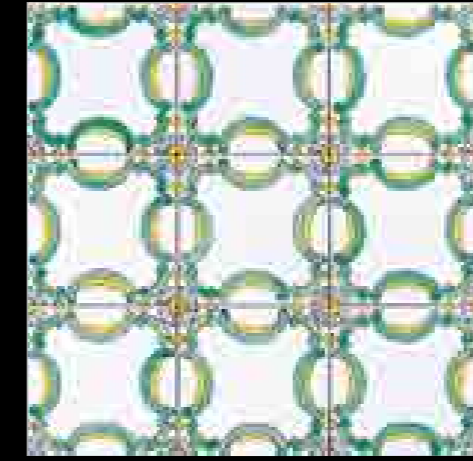

Gianna
Q198



Fiore Stilizzato
Q198



Maiori
Q198

Rivestimento: Rosalia 10x10. Bianco Vietri 10x10.
Torello Bianco Vietri 10x10. Bianco Vietri 5x5. "I Pennellati" Giallo 5x5.
Torcello 5x20 con doppio bordo Giallo e Blu



I Decori 10x10 4x4 inc.

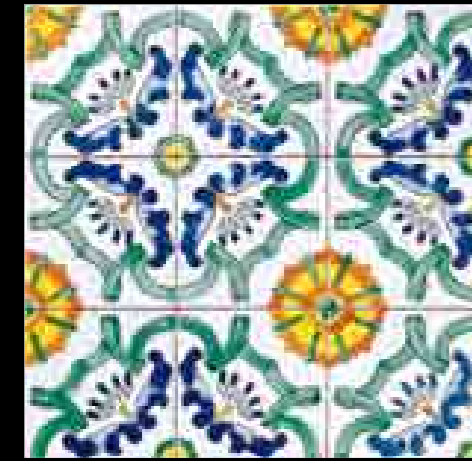

Maria Teresa Q198



Tulipani Q198



Leda Q198



Mirabella Q198



Rivestimento: "I Decori" Mirabella 10x10. Torello Verde Rame 10x10. "I Pennellati" Verde Rame 10x10.

I Festoni 10x10 4x4 inc.



Alessandra Z19



Raito Z19



Germana Z19



Aurelia Z19

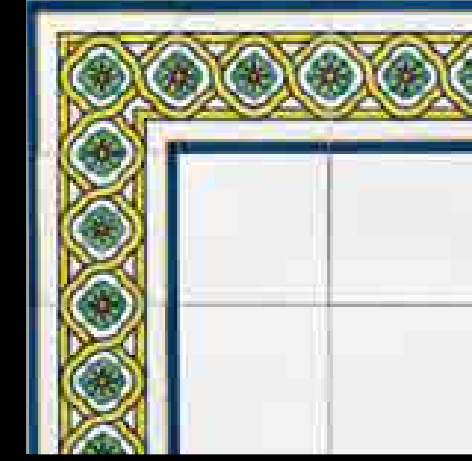

Federica Z19



Flavia Z19



Pompeiana Rosso Z19



Minori Z19



Rivestimento: "I Festoni" Verdiana 10x10. "I Pennelati" Verde Rame 10x10. Torello Bianco Vietri 10x10. Bianco Vietri 10x10.
Pavimento: "I Pennelati" Verde Rame 10x10.

L'antica arte di preziose mattonelle fatte a mano. The ancient art of fine handmade tiles.

I Festoni 10x10 4x4 inc.



Iside Z19



Verdiana Z19



Annachiara Blu Z19



Fiorella Z19



Priscilla Z19

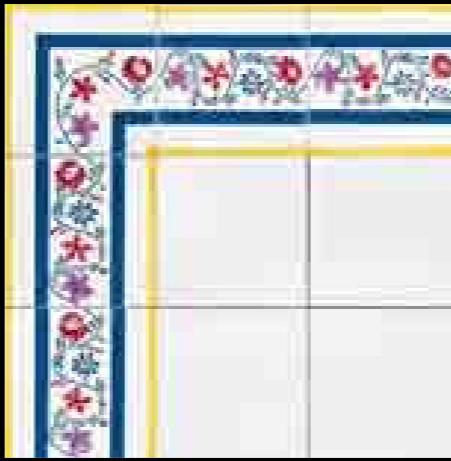

Valentina Z19

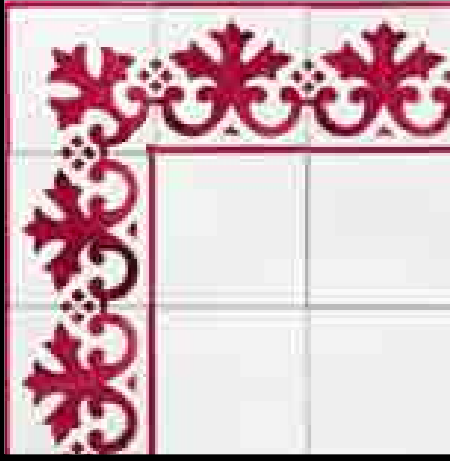

Ercolano Rosso Z19



Lulù Azzurro Z19

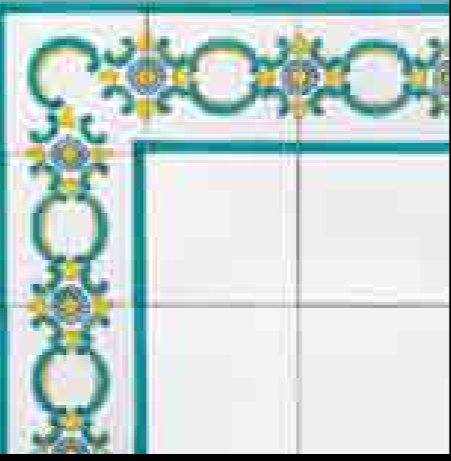

Verona Verde Nilo Z19



Angelica Z19



Tulipani Z19



Monica Z19



L'antica arte di preziose mattonelle fatte a mano. The ancient art of fine handmade tiles.



I Listelli 10x20 4x8 inc.

Il formato 10x20 viene solitamente utilizzato per un inserimento nel rivestimento. Un suo eventuale utilizzo come terminale dovrebbe prevederne la costa superiore smaltata. In tal caso è opportuno farne esplicita richiesta. Per ulteriori informazioni consultare la sezione tecnica. Oltre quelli proposti, è possibile la realizzazione di altri decori.



The 10x20 size is generally used as an insert in the covering. In order to use it for bordering it should have an upper glazed border. For this purpose an explicit demand is required. Further information can be had from our Technical Department. It is possible to create other decorations apart the ones mentioned here.



I Listelli 10x20 4x8 inc.

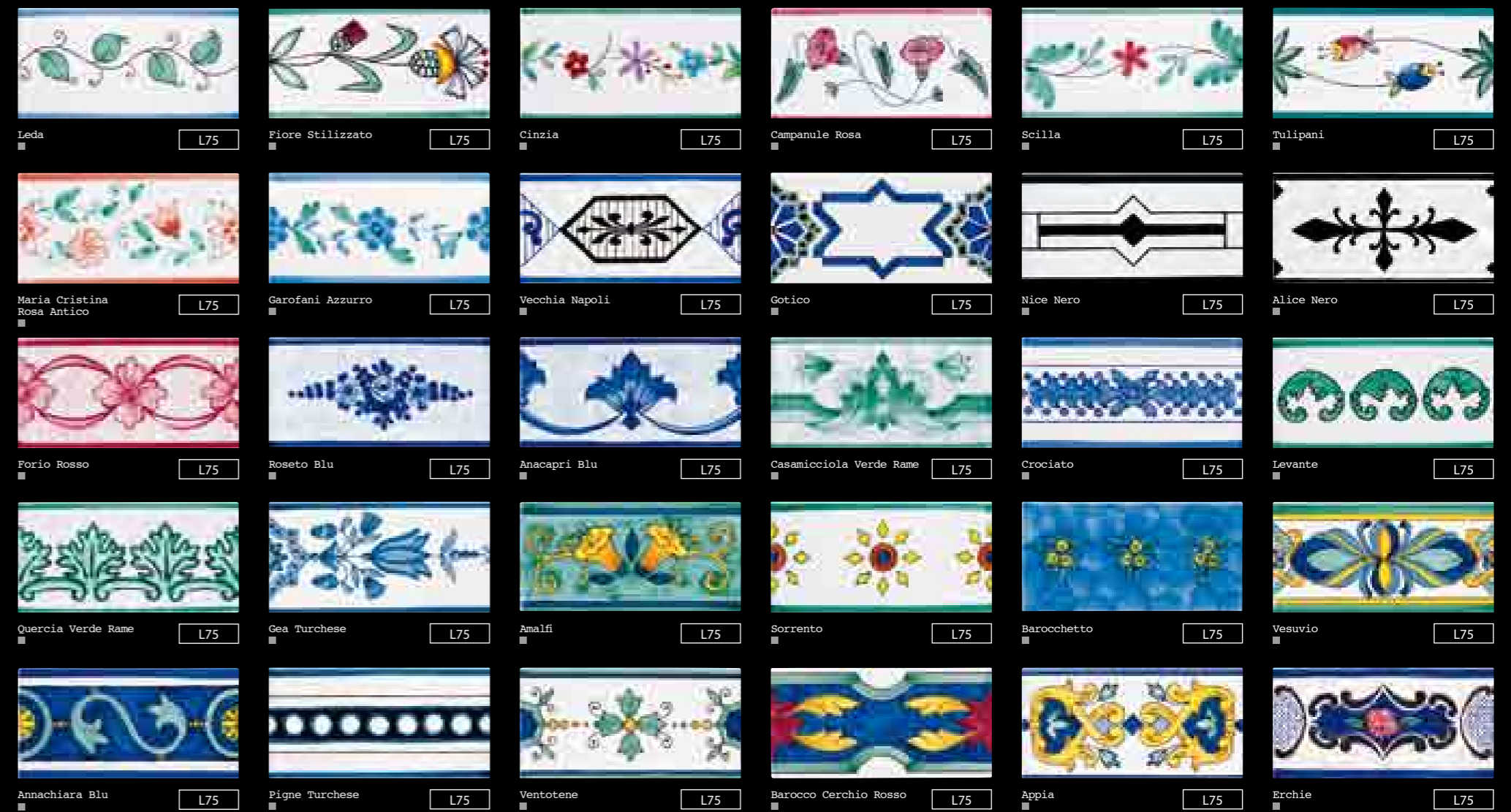
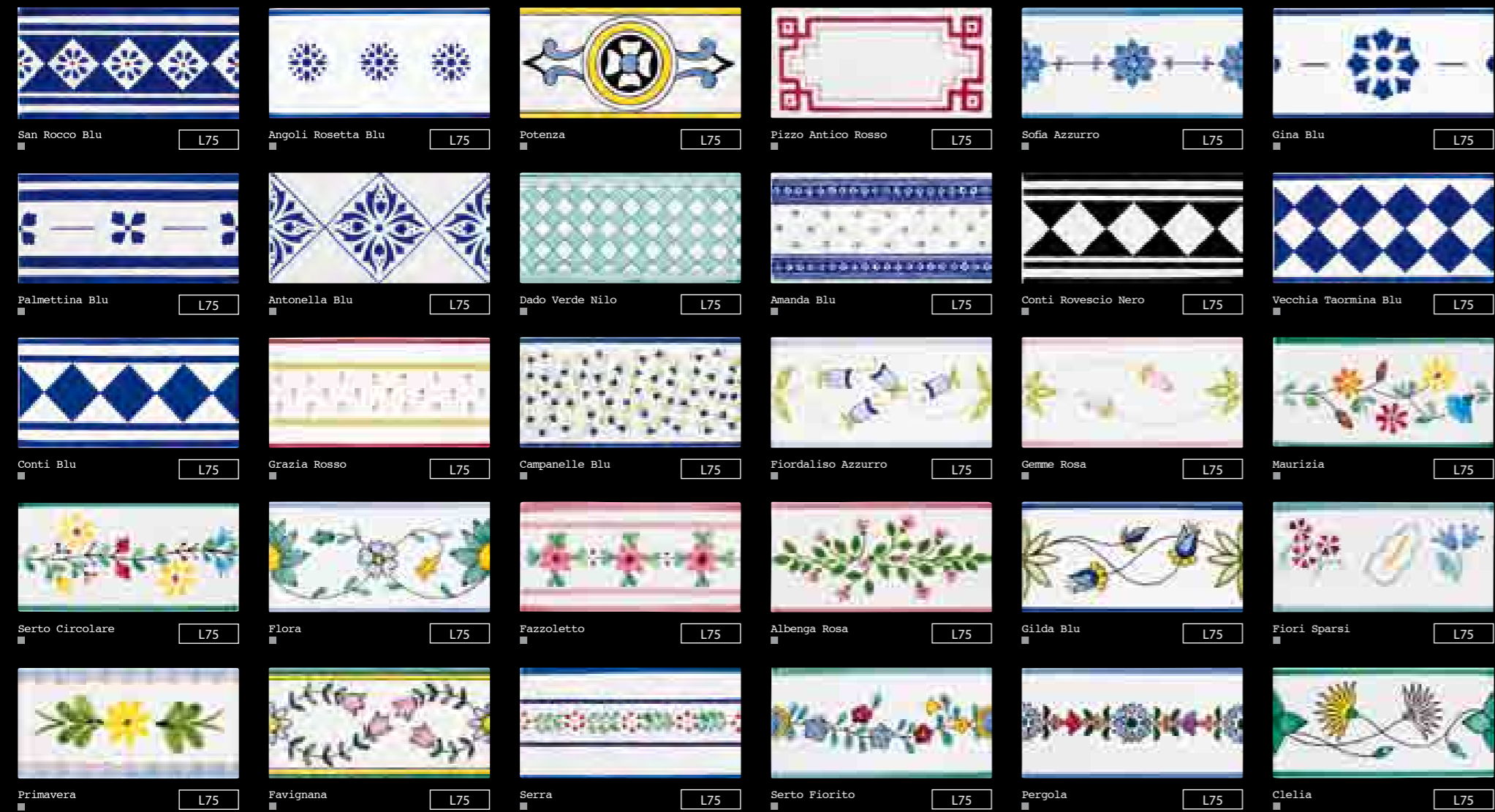

L'antica arte di preziose mattonelle fatte a mano. The ancient art of fine handmade tiles.

I Listelli 10x20 4x8 inc.



Cetara L75



Aurora L75



Linda L75

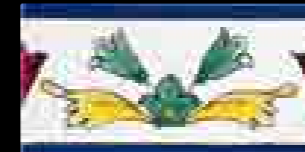

Barocco Rosso e Blu L75

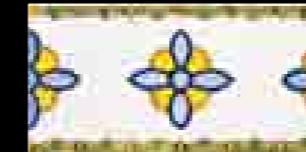

Viareggio L75



Maria Teresa L75



Capodimonte L75

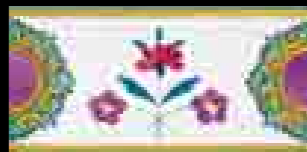

Santa Lucia L75

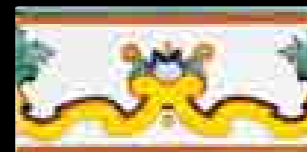

Camaldoli L75

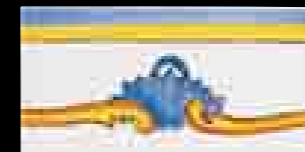

Valeria L75



Siepe L75



Settecento L75

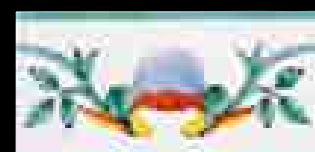

Gloria L75



Verone Verde Nilo L75



Aurelia L75

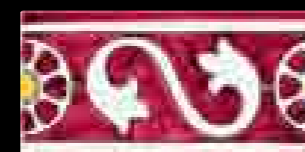

Pompeiana Rosso L75



Alessandra L75



Germana L75

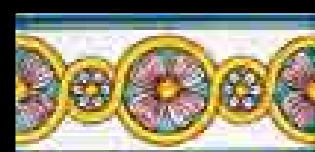

Angelica L75



Ercolano Rosso L75



Iside L75



Raito L75



Monica L75



Minori L75



Pilastro Blu L75

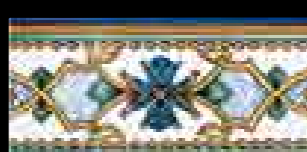

Pithecura L75



Ravello Verde Nilo L75



Normanno Blu L75



Alessia L75

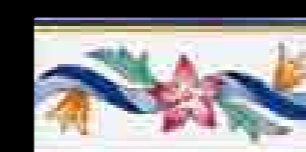

Marisa L75



Greca Classica Blu L75



Epomeo L75



Erica L75



Marina Piccola Verde Nilo L75



Ondina Blu L75



Daniela Rosa L75

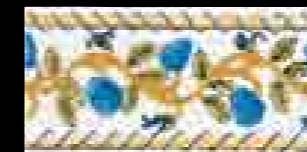

Mary L75

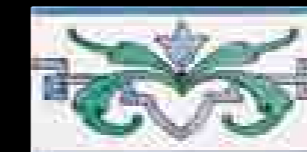

Samantha L75



Amelia Azzurro L75



Delia Rosa Antico L75



Tralcio d'Uva L75



Visconti Azzurro L75



Edera Blu L75

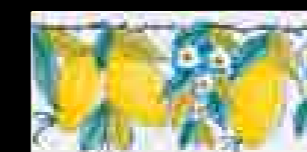

Limoni L75

I LISTELLI 10x20

BIANCO VIETRI	Q88
PENNELATO	Q108
SPUGNATO	Q118
DECORI ANGOLO (su 10x10)	Z19

L'antica arte di preziose mattonelle fatta a mano. The ancient art of fine handmade tiles.



I Listelli Sagomati 10x20 4x8 inc.

Il formato 10x20 Sagomato viene solitamente utilizzato per un inserimento nel rivestimento. Un suo eventuale utilizzo come terminale dovrebbe prevederne la costa superiore smaltata. In tal caso è opportuno farne esplicita richiesta. Per ulteriori informazioni consultare la sezione tecnica. Oltre quelli proposti, è possibile la realizzazione di altri decori.



The 10 x 20 Sagomato size is generally used as an insert in the covering. In order to use it for bordering it should have an upper glazed border. For this purpose an explicit demand is required. Further information can be had from our Technical Department. It is possible to create other decorations apart the ones mentioned here.





I Listelli Sagomati 10x20 4x8 inc.

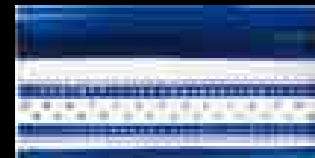

Amanda Blu L85



Conti Blu L85



Emma Azzurro L85

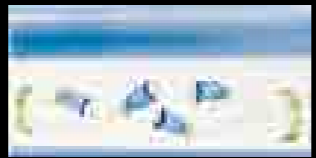

Fiordaliso Azzurro L85

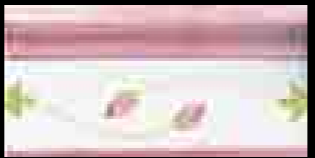

Gemme Rosa L85

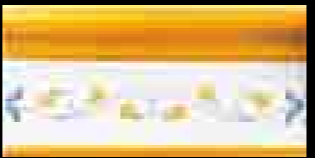

Giulia Gialloarancio L85

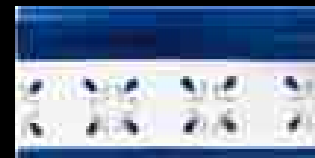

Gocce Blu L85



Lia Rosso L85



Maurizia L85

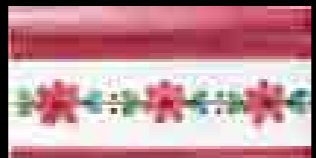

Fazzoletto L85

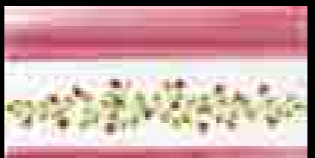

Albenga Rosa L85



Serto Fiorito L85



Leda L85



Fiore Stilizzato L85



Campanule Rosa L85



Scilla L85



Tulipani L85

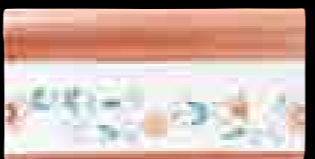

Maria Cristina Rosa Antico L85

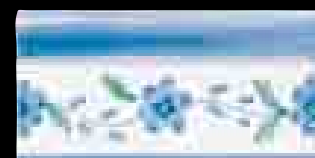

Garofani Azzurro L85



Roseto Blu L85



Amalfi L85

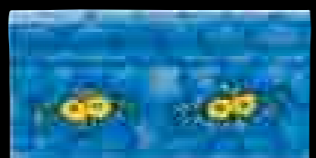

Barocchetto L85



Annachiara Blu L85

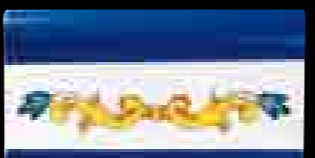

Appia L85



Linda L85



Gloria L85

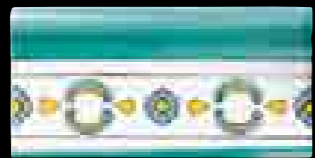

Verona Verde Nilo L85



Pompeiana Rosso L85



Alessandra L85



Angelica L85



Lulù Azzurro L85



Minori L85



Epomeo L85



Marina Piccola L85



Visconti Azzurro L85



Amelia Azzurro L85



Delia Rosa Antico L85



Samantha L85



Salina L85

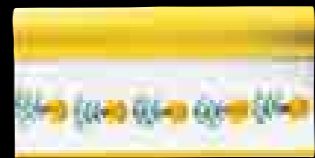

Ivana Giallo L85



Effie Azzurro L85



Mirella L85



Peonia Rosso L85

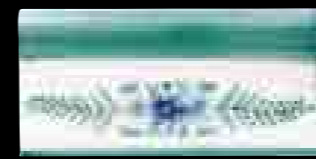

Felce Fiorita L85



Marianna L85



Fiori di Campo L85



Rossella L85



Eleonora L85

I LISTELLI SAGOMATI 10x20

BIANCO VIETRI	L50
PENNELATO	L70
SPUGNATO	L75

PEZZI SPECIALI PER LISTELLI SAGOMATI 10x20

SPIGOLO SAGOMATO

BIANCO VIETRI	Z22
PENNELATO	Z24
SPUGNATO	Z26

ANGOLO SAGOMATO

BIANCO VIETRI	Z27
PENNELATO	Z29
SPUGNATO	Z30
DECORATO	Z33



L'antica arte di preziose mattonelle fatta a mano. The ancient art of fine handmade tiles.



I Listelli 6,5x26 2,5x10 inc.

Ogni listello 6,5x26 prevede un relativo decoro ad angolo realizzato nel formato 6,5x6,5. Il formato 6,5x26 viene solitamente utilizzato per un inserimento nel rivestimento. Un suo eventuale utilizzo come terminale dovrebbe prevederne la costa superiore smaltata. In tal caso è opportuno farne esplicita richiesta. Oltre quelli proposti è possibile la realizzazione di altri decori.



Each 6,5x26 Listello (Strip Tile) provides for a matching corner decoration in 6,5x6,5 size. The 6,5x26 size is generally used as an insert in the covering. In order to use it for bordering it should have an upper glazed border. In this case an explicit demand is required. It is possible to make other decorations apart from the ones mentioned here.





I Listelli 6,5x26 2,5x10 inc.



San Rocco Blu Z33



Pavus Blu Z33



Angoli Rosetta Blu Z33



Gina Blu Z33



Sofia Azzurro Z33



Palmettina Blu Z33



Dado Rosa e Grigio Z33



Conti Blu Z33



Conti Rovescio Nero Z33



Amanda Blu Z33



Grazia Rosso Z33



Gemme Rosa Z33



Domina Giallo Z33

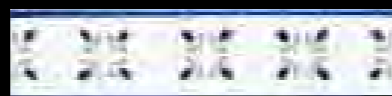

Gocce Blu Z33

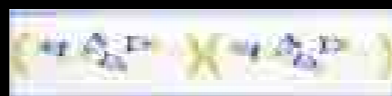

Fiordaliso Azzurro Z33



Alpina Blu Z33

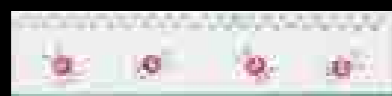

Martina Rosso Z33

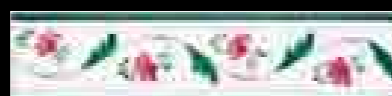

Liliana Rosa Z33



Tulipani Z33

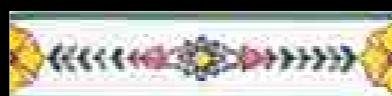

Favignana Z33



Leda Z33



Clelia Z33



Scilla Z33



Gilda Z33



Fiore Stilizzato Z33



Cetara Z33



Caterina Rosa Z33

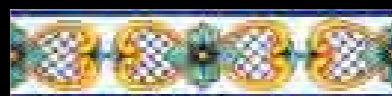

Ischia Z33

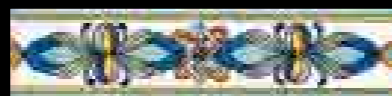

Vesuvio Z33



Maria Teresa Z33



Gloria Z33

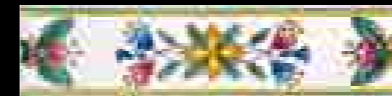

Puteoli Z33



Linda Z33

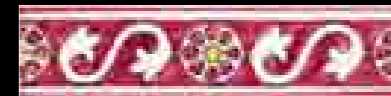

Pompeiana Rosso Z33



Annachiara Blu Z33



Fiorella Z33



Valentina Z33



Ondina Blu Z33

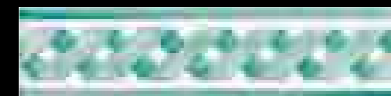

Marina Piccola Verde Nilo Z33



Pilastro Blu Z33

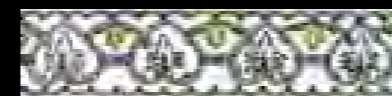

Erica Z33



Alessia Z33



Delia Rosa Antico Z33



Visconti Azzurro Z33



Tania Z33



Berta Blu Z33



Greca Classica Blu Z33



Amelia Azzurro Z33

I LISTELLI 6,5x26

BIANCO VIETRI	Z13
PENNELATO	Z21
SPUGNATO	Z23
DECORI ANGOLO (su 6,5x6,5)	Z35



L'antica arte di preziose mattonelle fatte a mano. The ancient art of fine handmade tiles.

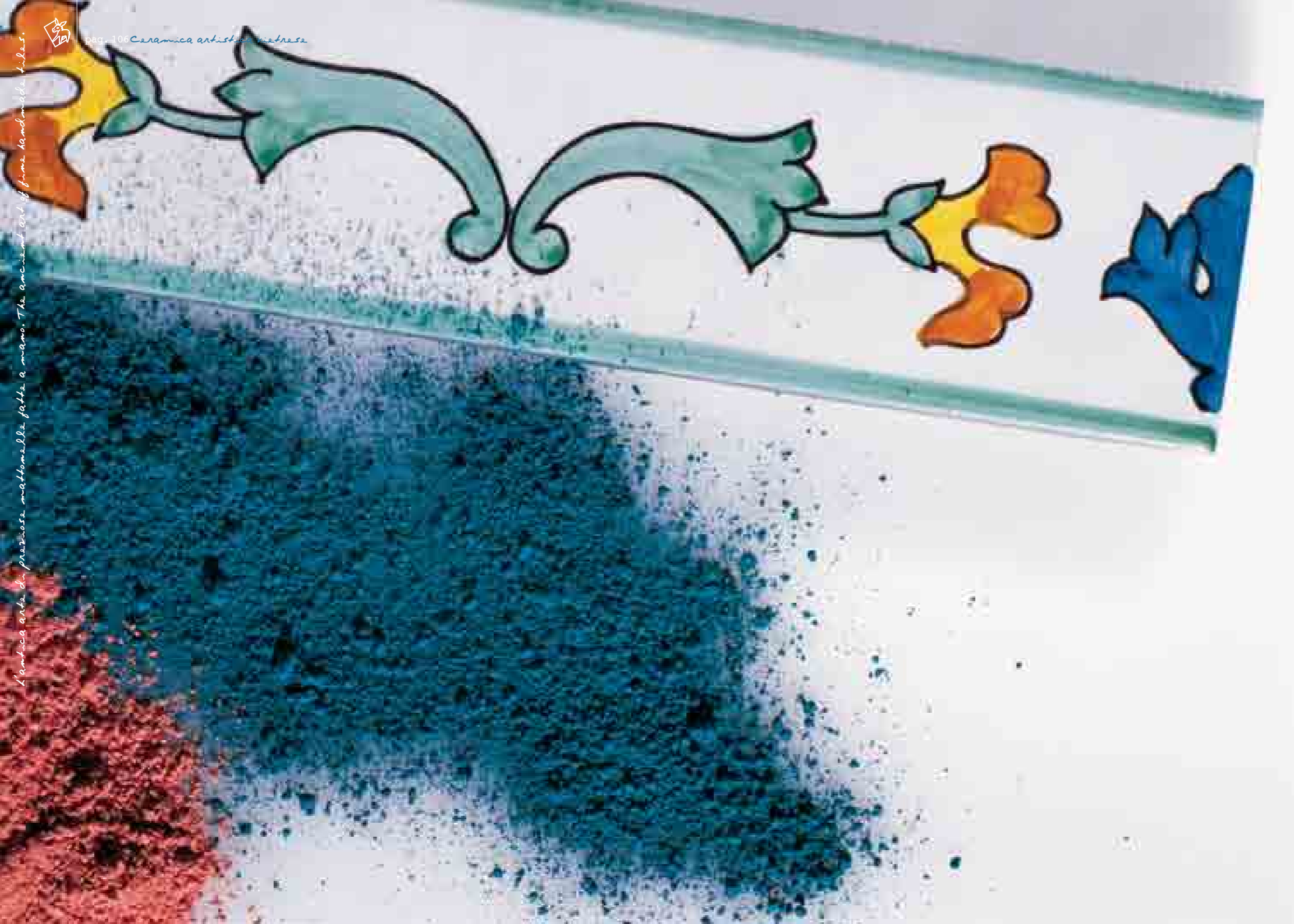

I Listelli 5x20 2x8 inc.

Ogni listello 5x20 prevede un relativo decoro ad angolo realizzato nel formato 5x5. Il formato 5x20 viene solitamente utilizzato per un inserimento nel rivestimento. Un suo eventuale utilizzo come terminale dovrebbe prevederne la costa superiore smaltata. In tal caso è opportuno farne esplicita richiesta. Oltre quelli proposti è possibile la realizzazione di altri decori.



Each 5x20 Listello (Strip Tile) provides for a matching corner decoration in the 5x5 size. The 5x20 size is generally used as an insert in the covering. In order to use it for bordering, it should have an upper glazed border. In this case an explicit demand is required. It is possible to make other decorations apart from the ones mentioned here.





I Listelli 5x20 2x8 inc.



I LISTELLI 5x20

BIANCO VIETRI	Z10
PENNELATO	Z17
SPUGNATO	Z22
DECORI ANGOLO (su 5x5)	Z33



L'antica arte di preziose mattonelle fatte a mano. The ancient art of fine handmade tiles.



I Torcelli 5x20 - 2x8 inc.

Il formato Torcello 5x20 e 5x13 può essere utilizzato sia come terminale del rivestimento che come pezzo speciale nei top bagno e cucina. Per ulteriori informazioni consultare la sezione tecnica. Su richiesta, oltre quelli proposti, è possibile la realizzazione di altri decori.

The Torcello size - 2x8 inc. - can be used either as a covering border or as a special piece for bathroom tops and kitchen worktops. For further information, please consult the technical section in this catalogue. On request it is possible to make other decorations, apart from the ones mentioned here.



I TORCELLI 5x20

BIANCO VIETRI	Z18
PENNELATO	Z27
SPUGNATO	Z29

PEZZI SPECIALI PER I TORCELLI 5x20

ANGOLO, SPIGOLO INTERNO, SPIGOLO ESTERNO	Z23
BIANCO VIETRI	Z23
PENNELATO	Z29
SPUGNATO	Z31
DECORATO	Z37



Liscio o Bombato 3x20 1x8 inc.

Il formato 3x20 sia nella versione bombata che liscia viene solitamente utilizzato per un inserimento nel rivestimento. Un suo eventuale utilizzo come terminale o giro specchio dovrebbe prevederne una costa smaltata. In tal caso è opportuno farne esplicita richiesta. Per ulteriori informazioni consultare la sezione tecnica. Su richiesta, oltre quelli proposti, è possibile la realizzazione di altri decori.

The 1x8 inc. size, both in convex and smooth versions, is generally used as an insert in the coverings. For its eventual use as a border or as a mirror frame it should have a glazed border. In this case a specific order is required. For further information, please consult the technical section in this catalogue. On request, it is possible to make other decorations apart from the ones mentioned here.



LISCIO O BOMBATO 3x20	
BIANCO VIETRI	Z16
PENNELATO	Z21
SPUGNATO	Z25

PEZZI SPECIALI PER BOMBATO	
ANGOLO, SPIGOLO INTERNO, SPIGOLO ESTERNO	
BIANCO VIETRI	Z23
PENNELATO	Z25
SPUGNATO	Z27
DECORATO	Z29



I Pannelli Decorativi.

I pannelli presentati in questa sezione sono esemplificativi. I soggetti e le dimensioni sono realizzabili, su richiesta, nei formati 10x10, 13x13, 20x20.



The panels shown in this section are merely presented as an example. The subjects and the dimensions can be made on demand, in the following sizes 4x4 inc., 5x5 inc., 8x8 inc.





Pannelli Decorativi.

L'antica arte di preziosa maiolicella fatta a mano. The ancient art of fine handmade tiles.



Vaso con Fiori

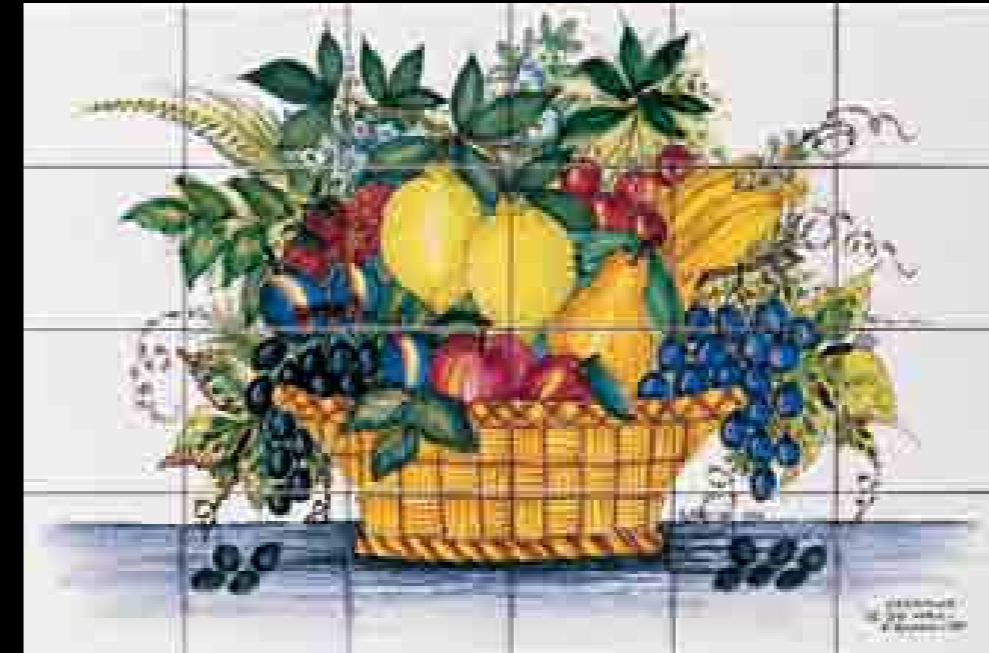

Cesto con Frutta



Lago dei Cigni



PANNELLI DISPONIBILI A DIMENSIONI VARIABILI SU RICHIESTA. PREZZO A SINGOLA PIASTRELLA. PANELS AVAILABLE IN OTHER FORMATS ON REQUEST. PRICE OF SINGLE TILE.

10x10	Z50
13x13	Z66
20x20	Z106



PANNELLI DISPONIBILI A DIMENSIONI VARIABILI SU RICHIESTA. PREZZO A SINGOLA PIASTRELLA. PANELS AVAILABLE IN OTHER FORMATS ON REQUEST. PRICE OF SINGLE TILE.

10x10	Z50
13x13	Z66
20x20	Z106



Pannelli Decorativi.



Acquario



Paesaggio Vietnese

PANNELLI DISPONIBILI A DIMENSIONI VARIABILI SU RICHIESTA. PREZZO A SINGOLA PIASTRELLA. PANELS AVAILABLE IN OTHER FORMATS ON REQUEST. PRICE OF SINGLE TILE.

10x10	Z50
13x13	Z66
20x20	Z106

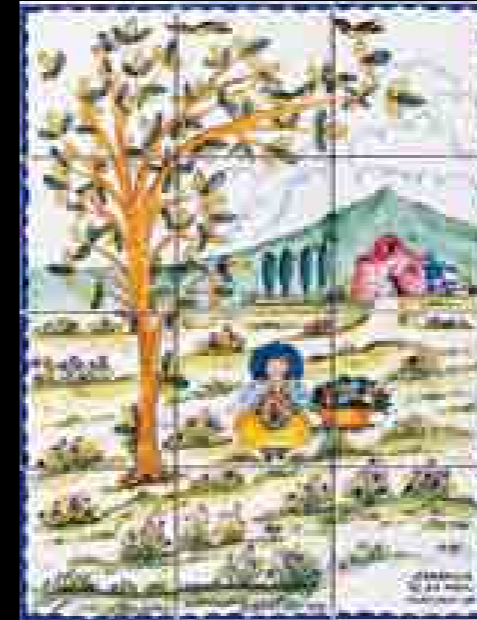

Le Stagioni: Primavera

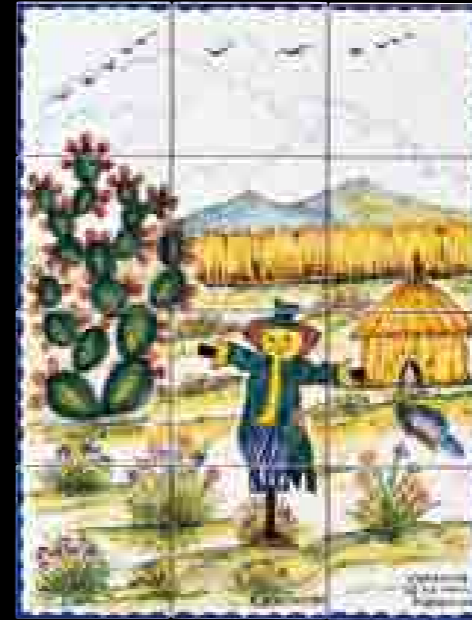

Le Stagioni: Estate

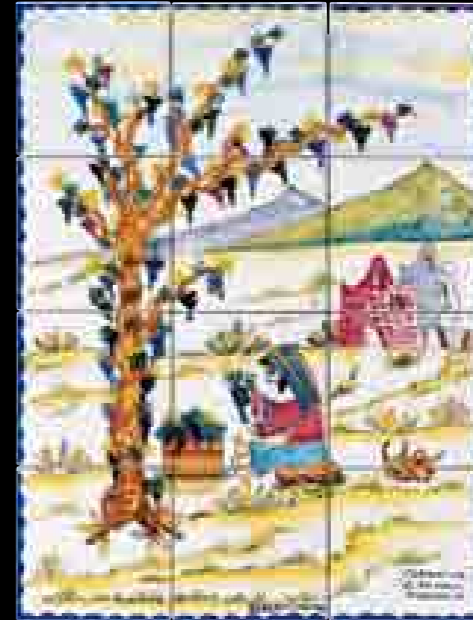

Le Stagioni: Autunno

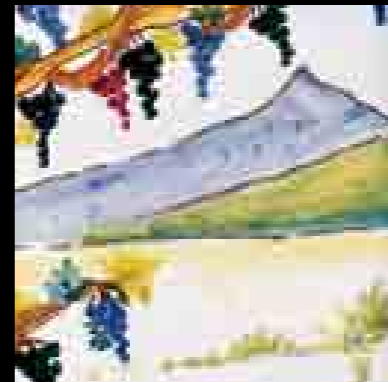

Le Stagioni: Inverno



PANNELLI DISPONIBILI A DIMENSIONI VARIABILI SU RICHIESTA. PREZZO A SINGOLA PIASTRELLA. PANELS AVAILABLE IN OTHER FORMATS ON REQUEST. PRICE OF SINGLE TILE.

10x10	Z50
13x13	Z66
20x20	Z106

L'antica arte di preziosa mattonelle fatte a mano. The ancient art of fine handmade tiles.



Le Piastrelle a Rilievo.

Le formelle a rilievo possono essere realizzate anche in "Bianco Vietri".

The tiles in relief "formelle" can also be created in "Bianco Vietri".

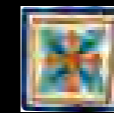

Quadrifoglio
7x7-3x3 inc.
Z52

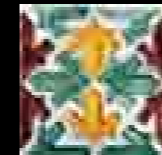

Zampe di Gallo
10x10-4x4 inc.
Z52

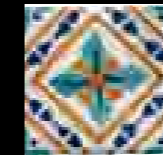

Toledo
10x10-4x4 inc.
Z52

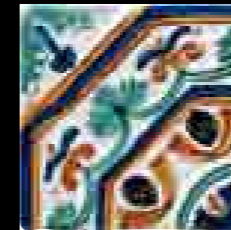

Ottagono
14x14-5,5x5,5 inc.
Z74



Quadrifoglio
14x14-5,5x5,5 inc.
Z74

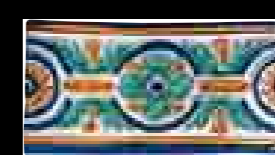

Esmeralda
9x18-3,5x7 inc.
Z74



Dragonea
9x18-3,5x7 inc.
Z74

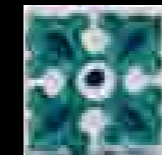

Ortensia
10x10-4x4 inc.
Z52

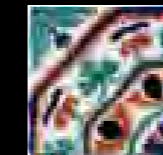

Ottagono
10x10-4x4 inc.
Z52

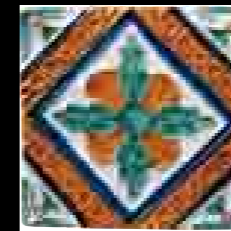

Toledo
14x14-5,5x5,5 inc.
Z74

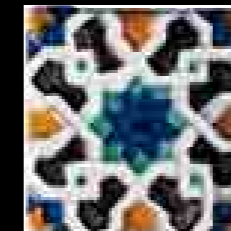

Moresco
14x14-5,5x5,5 inc.
Z74

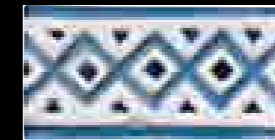

Visconti
9x18-3,5x7 inc.
Z74



Limoni
12,5x20-5x8 inc.
Z74



l'antica arte di preparare mattonelle fatte a mano. The ancient art of fine handmade tiles.

Levia

LEVIA propone delicate ed innovative alchimie cromatiche nel rispetto della storia secolare che continua ad accompagnarci nei riti di laboratorio, nelle mille attenzioni necessarie ad un processo di lavorazione, nei metodici gesti quotidiani. L'intuito al centro di tutto, l'espressione di una innata sensibilità artistica che nessuna tecnologia sarà in grado di generare.

La materia è quella di sempre, semplice ed eterna, resistente ed affidabile. Delicatissimi fondi a stucco, decori nitidi realizzati a stencil. La totale manualità nella produzione genera lievi imperfezioni che fanno di ogni mattonella un pregiato pezzo unico.

Dodici i fondi decorati a stucco, dodici i decori realizzati a stencil, centoquarantaquattro combinazioni. Colori caldi, avvolgenti, mediterranei, solari, inondati dalla luce che ci accompagna ogni giorno.



LEVIA proposes delicate and innovative colour alchemistries following the century-old tradition which is still present in the workshop rites, the great care taken in the manufacturing process, in the daily methodical gestures. Intuition is the centre of everything, the expression of an inborn artistic sensitivity which no technology will ever be able to imitate.

The material used is the same as always, simple, eternal, resistant and reliable. Very delicate stucco surfaces, clean stencil decorations. The entirely handmade production produces light faults which make each tile a precious unique piece.

There are twelve stucco decorated surfaces, and also include the stencil decorations, one hundred and forty combinations. Warm, embracing, Mediterranean, sun colours bathed in the sunlight which accompanies us every day.

Agnese 20x20 8x8 inc.



Stucco Turchese Q84



Greca L70



Angolo tipo B L70

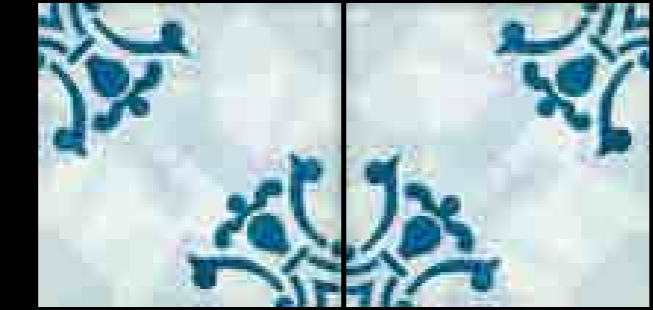

Decoro Q128



Angolo tipo A L70



Decoro Q128



Decoro Q128

Decorazioni disponibili: Agata, Apollonia, Cecilia, Cleopatra, Cristiana, Dionisia, Ester, Felicita, Fosca, Lucrezia e Sabina

15x30-7,5x30 6x12-3x12 inc.

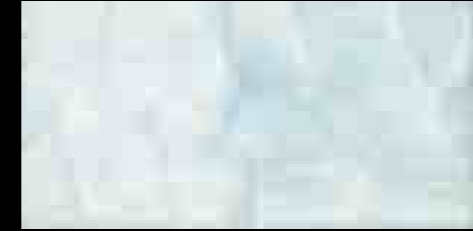

Stucco Turchese Q98



Stucco Turchese Z25



Listello Z31



Pennellato Turchese Q76



Pennellato Turchese Z21

Bianco 15x30	Q60
Bianco 7,5x30	Z13

Apollonia 20x20 8x8 inc.



Stucco Azzurro Q84



Greca L70



Angolo tipo B L70



Angolo tipo A L70



Decoro Q128

Decorazioni disponibili: Agata, Agnese, Cecilia, Cleopatra, Cristiana, Dionisia, Ester, Felicita, Fosca, Lucrezia e Sabina

15x30-7,5x30 6x12-3x12 inc.

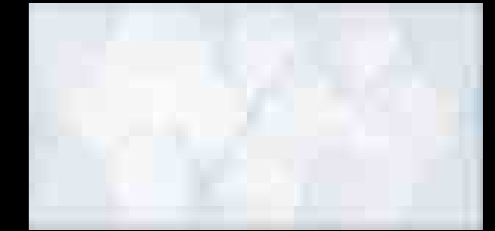

Stucco Azzurro Q98



Stucco Azzurro Z25



Listello Z31



Pennellato Bleu Q76



Pennellato Bleu Z21

Bianco 15x30	Q60
Bianco 7,5x30	Z13

L'antica arte di preziosa mattonelle fatta a mano. The ancient art of fine handmade tiles.

Fosca 20x20 8x8 inc.



Stucco SM59 Q84



Greca L70



Angolo tipo B L70

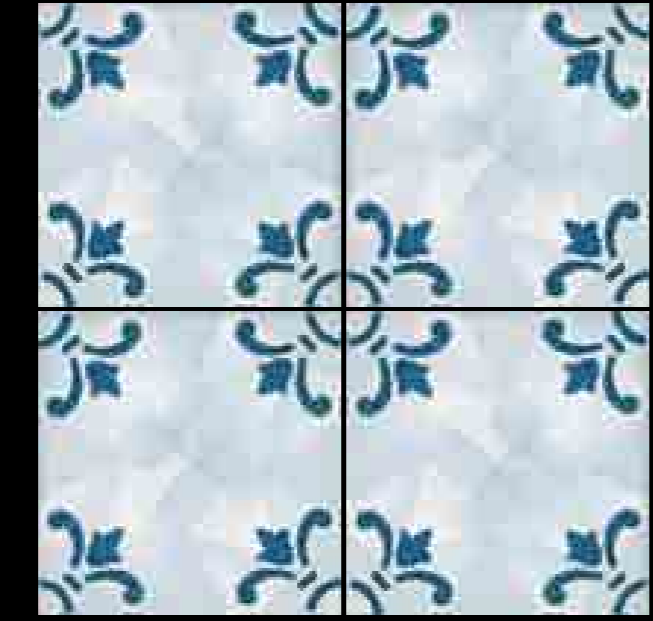

Angolo tipo A L70



Decoro Q128

Decorazioni disponibili: Agata, Agnese, Apollonia, Cecilia, Cleopatra, Cristiana, Dionisia, Ester, Felicità, Lucrezia e Sabina

15x30-7,5x30 6x12-3x12 inc.



Stucco SM59 Q98



Stucco SM59 Z25



Listello Z31



Pennellato SM59 Q76



Pennellato SM59 Z21

Bianco 15x30	Q60
Bianco 7,5x30	Z13

Dionisia 20x20 8x8 inc.



Stucco Verde Rame Q84

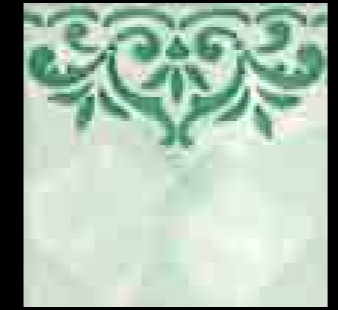

Greca L70

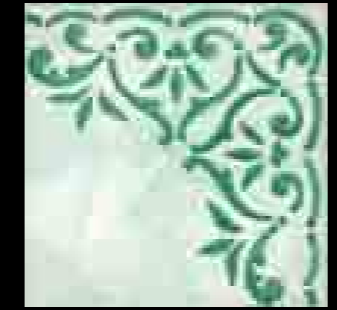

Angolo tipo B L70

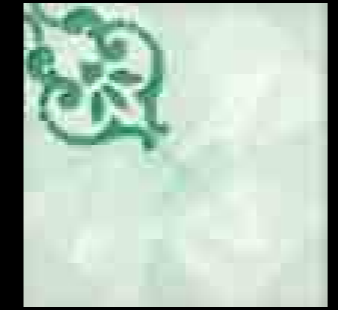
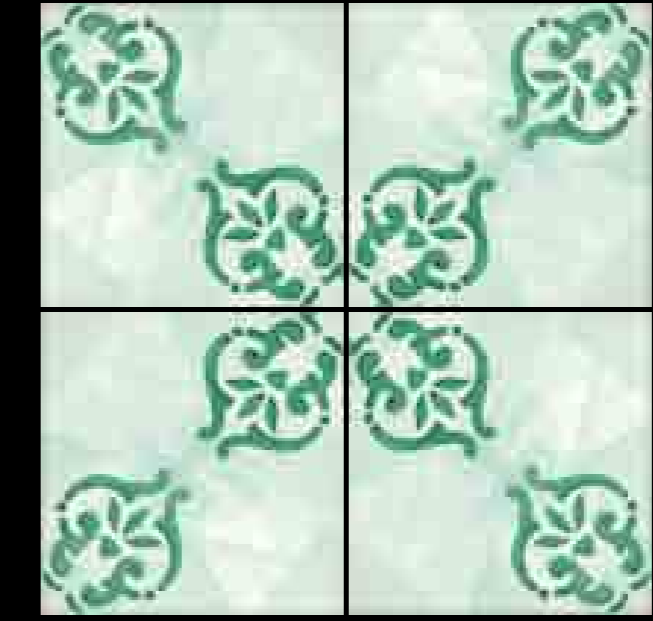

Angolo tipo A L70

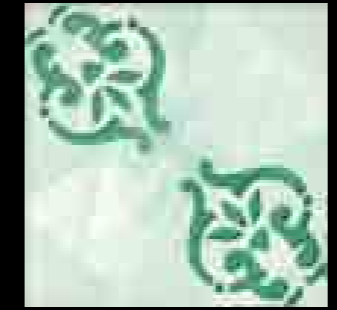

Decoro Q128

Decorazioni disponibili: Agata, Agnese, Apollonia, Cecilia, Cleopatra, Cristiana, Ester, Felicità, Fosca, Lucrezia e Sabina

15x30-7,5x30 6x12-3x12 inc.



Stucco Verde Rame Q98



Stucco Verde Rame Z25



Listello Z31



Pennellato Verde Rame Q76



Pennellato Verde Rame Z21

Bianco 15x30	Q60
Bianco 7,5x30	Z13

L'antica arte di preziosa mattonelle fatta a mano. The ancient art of fine handmade tiles.

Ester 20x20 8x8 inc.

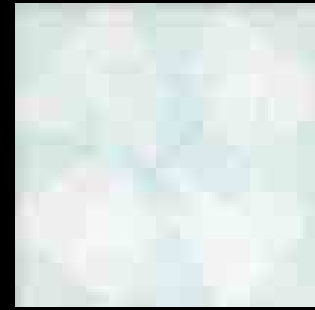

Stucco Verde Nilo Q84



Greca L70

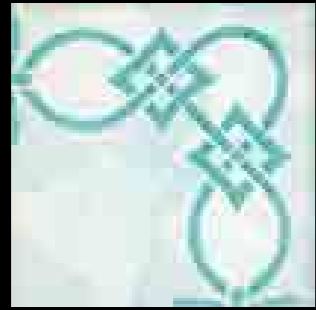

Angolo tipo B L70

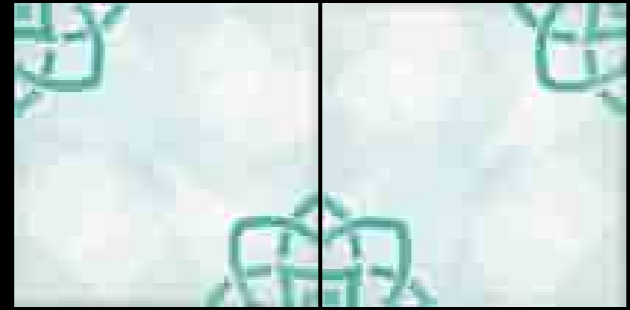

Decoro Q128



Angolo tipo A L70



Decoro Q128

Decorazioni disponibili: Agata, Agnese, Apollonia, Cecilia, Cleopatra, Cristiana, Dionisia, Felicita, Fosca, Lucrezia e Sabina

15x30-7,5x30 6x12-3x12 inc.

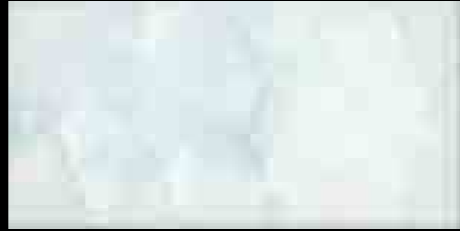

Stucco Verde Nilo Q98



Stucco SM59 Z25



Listello Z31



Pennellato Verde Nilo Q76



Pennellato Verde Nilo Z21

Bianco 15x30	Q60
Bianco 7,5x30	Z13

Cristiana 20x20-15x30 8x8-6x12 inc.

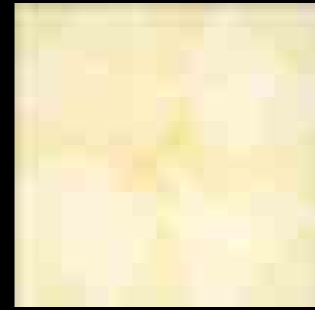

Stucco Camoscio Q84



Greca L70



Angolo tipo B L70

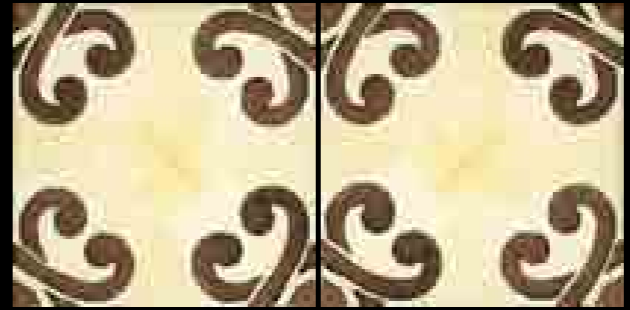

Decoro Q128



Angolo tipo A L70



Decoro Q128

Decorazioni disponibili: Agata, Agnese, Apollonia, Cecilia, Cleopatra, Dionisia, Ester, Felicita, Fosca, Lucrezia e Sabina

15x30-7,5x30 6x12-3x12 inc.

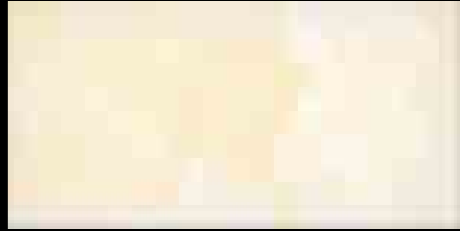

Stucco Camoscio Q98



Stucco Camoscio Z25



Listello Z31



Pennellato Manganese Q76



Pennellato Manganese Z21

Bianco 15x30	Q60
Bianco 7,5x30	Z13

L'antica arte di preziosa mattonelle fatte a mano. The ancient art of fine handmade tiles.

Lucrezia 20x20 8x8 inc.

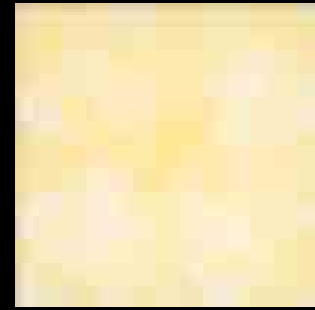

Stucco Giallo Arancio Q84



Greca L70



Angolo tipo B L70

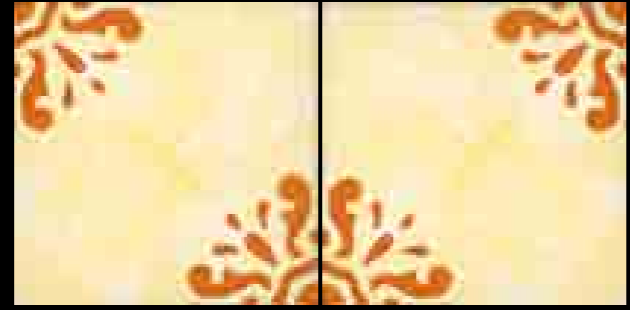

Decoro Q128



Angolo tipo A L70



Decoro Q128

Decorazioni disponibili: Agata, Agnese, Apollonia, Cecilia, Cleopatra, Cristiana, Dionisia, Ester, Felicità, Fosca e Sabina

15x30-7,5x30 6x12-3x12 inc.

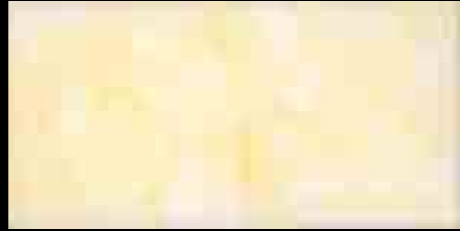

Stucco Giallo Arancio Q98



Stucco Giallo Arancio Z25



Listello Z31



Pennellato Arancio Q76



Pennellato Arancio Z21

Bianco 15x30	Q60
Bianco 7,5x30	Z13

Felicità 20x20 8x8 inc.



Stucco Rosa Q84



Greca L70



Angolo tipo B L70



Angolo tipo A L70



Decoro Q128

Decorazioni disponibili: Agata, Agnese, Apollonia, Cecilia, Cleopatra, Cristiana, Dionisia, Ester, Fosca, Lucrezia e Sabina

15x30-7,5x30 6x12-3x12 inc.



Stucco Rosa Q98



Stucco Rosa Z25



Listello Z31

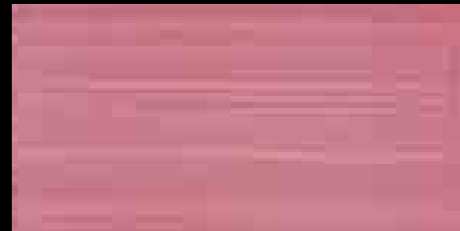

Pennellato Rosso Q76

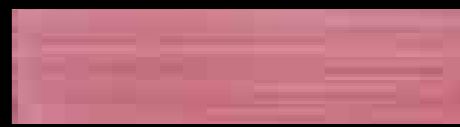

Pennellato Rosso Z21

Bianco 15x30	Q60
Bianco 7,5x30	Z13

L'antica arte di preziosa mattonelle fatta a mano. The ancient art of fine handmade tiles.

Cecilia 20x20 8x8 inc.

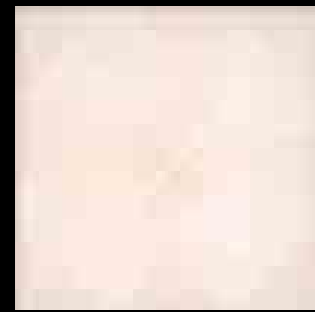

Stucco Rosa Antico Q84



Greca L70



Angolo tipo B L70



Angolo tipo A L70

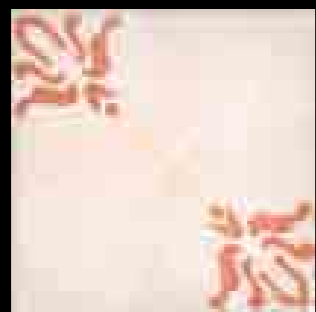

Decoro Q128

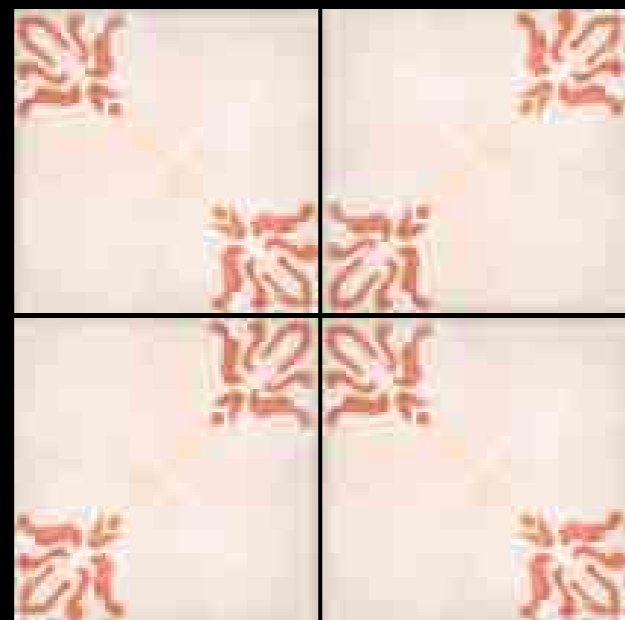

Decorazioni disponibili: Agata, Agnese, Apollonia, Cleopatra, Cristiana, Dionisia, Ester, Felicità, Fosca, Lucrezia e Sabina

15x30-7,5x30 6x12-3x12 inc.



Stucco Rosa Antico Q98



Stucco Rosa Antico Z25



Listello Z31

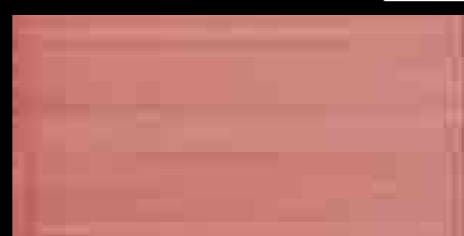

Pennellato Rosa Antico Q76

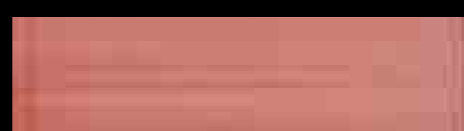

Pennellato Rosa Antico Z21

Bianco 15x30	Q60
Bianco 7,5x30	Z13

Sabina 20x20 8x8 inc.

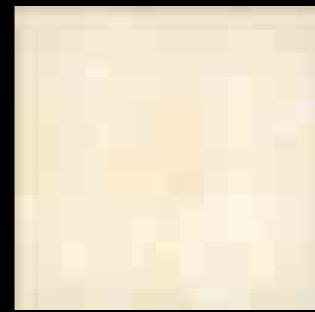

Stucco Avana Q84



Greca L70



Angolo tipo B L70



Angolo tipo A L70



Decoro Q128

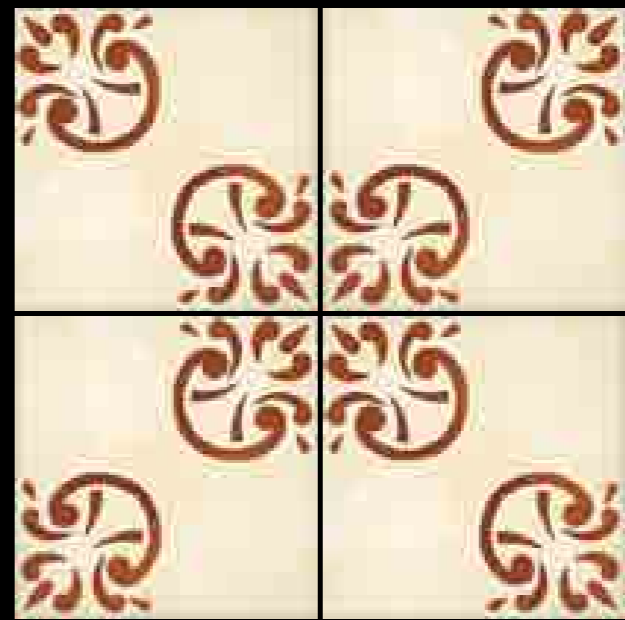

Decorazioni disponibili: Agata, Agnese, Apollonia, Cecilia, Cleopatra, Cristiana, Dionisia, Ester, Felicità, Fosca e Lucrezia

15x30-7,5x30 6x12-3x12 inc.



Stucco Avana Q98



Stucco Avana Z25



Listello Z31



Pennellato Bruno Rosso Q76



Pennellato Bruno Rosso Z21

Bianco 15x30	Q60
Bianco 7,5x30	Z13

Cleopatra 20x20 8x8 inc.



Stucco Manganese Q84

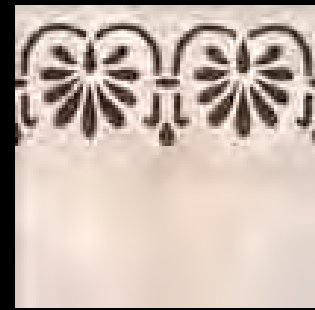

Greca L70



Angolo tipo B L70



Decoro Q128

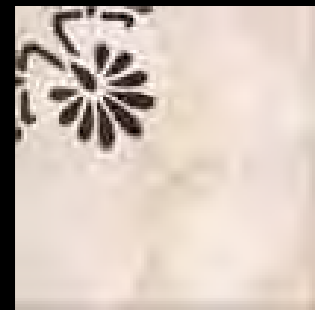

Angolo tipo A L70



Decoro Q128

Decorazioni disponibili: Agata, Agnese, Apollonia, Cecilia, Cristiana, Dionisia, Ester, Felicita, Fosca, Lucrezia e Sabina

15x30-7,5x30 6x12-3x12 inc.



Stucco Manganese Q98



Stucco Manganese Z25



Listello Z31



Pennellato Manganese Q76



Pennellato Manganese Z21

Bianco 15x30	Q60
Bianco 7,5x30	Z13

Agata 20x20 8x8 inc.

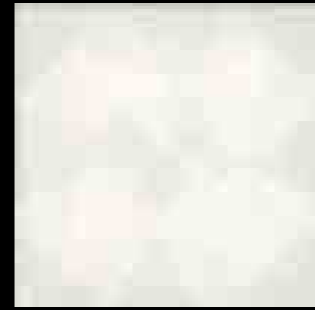

Stucco Grigio Q84



Greca L70



Angolo tipo B L70

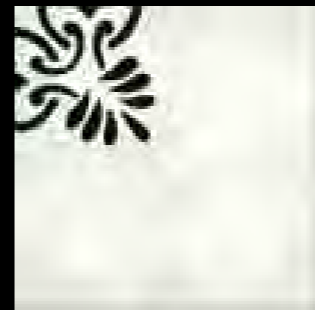

Angolo tipo A L70



Decoro Q128

Decorazioni disponibili: Agnese, Apollonia, Cecilia, Cleopatra, Cristiana, Dionisia, Ester, Felicita, Fosca, Lucrezia e Sabina

15x30-7,5x30 6x12-3x12 inc.

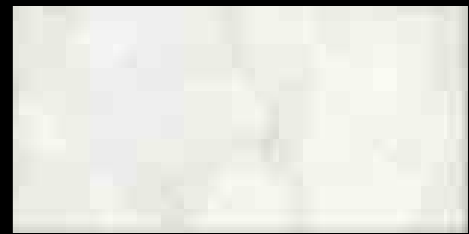

Stucco Grigio Q98



Stucco Grigio Z25



Listello Z31



Pennellato Nero Q76



Pennellato Nero Z21

Bianco 15x30	Q60
Bianco 7,5x30	Z13

L'antica arte di preziosa mattonelle fatte a mano. The ancient art of fine handmade tiles.

Cleopatra 20x20-15x30 8x8-6x12 inc.

L'antica arte di preziosa materielle fatta a mano. The ancient art of fine handmade tiles.



Agnese



Apollonia



Fosca



Dionisia



Ester



Cristiana

Cleopatra 20x20-15x30 8x8-6x12 inc.

L'antica arte di preziosa mattonelle fatte a mano. The ancient art of fine handmade tiles.



Lucrezia



Felicità



Cecilia



Sabina



Cleopatra



Agata



L'antica arte di preziosa mattonella fatta a mano. The ancient art of fine handmade tiles.

I Complementi.

Decorazione.

Data la particolare difficoltà nella filettatura e campitura del decoro l'oggetto passa alle mani sapienti dei nostri migliori maestri artigiani. I decori disponibili sono tutti quelli della nostra produzione.



DECORATION

Due to the particular difficulty of bordering and the background painting of the decoration, the object is handled by the hands of our expert Master Craftsman. All the decors of our production are available.



I Complementi.

L'antica arte di preziosa materielle fatta a mano. The ancient art of fine handmade tiles.



Portasale Z94



Portazucchero Z100



Portacaffè Z89



Brocca Z100



Portasciugamani ad anello Z137



Puntoluce ad un braccio Z168

Puntoluce a due braccia Z244



Portasapone a muro Z100



Portarotolo Z106



Portaspazzolino Z106



Dispenser Z108



Portaspazzolone Z124



Portasapone d'appoggio Z100



Portaspazzolone a muro Z120



Applique (cm 25) Z202



Appendiabito Z94



Copripesa ad uno, due o tre fori Z64

I Complementi.



Lampadario (ø cm 30) Z302



Portasciugamani Z168



Lavabo catino rotondo da appoggio
(Per misure e forme diverse consultare la sezione tecnica) Z323



Pomello Z32



Piede catino in ferro Z320

L'antica arte di preziosa materielle fatta a mano. The ancient art of fine handmade tiles.



Sezione Tecnica - *Technical Section.*

Formati. Pezzi Speciali. Schemi di Montaggio. Lavelli. Lavabi. Gocciolatoi. *Formats. Trims. Installation diagrams. Sinks. Washbasins. Drainboards.*

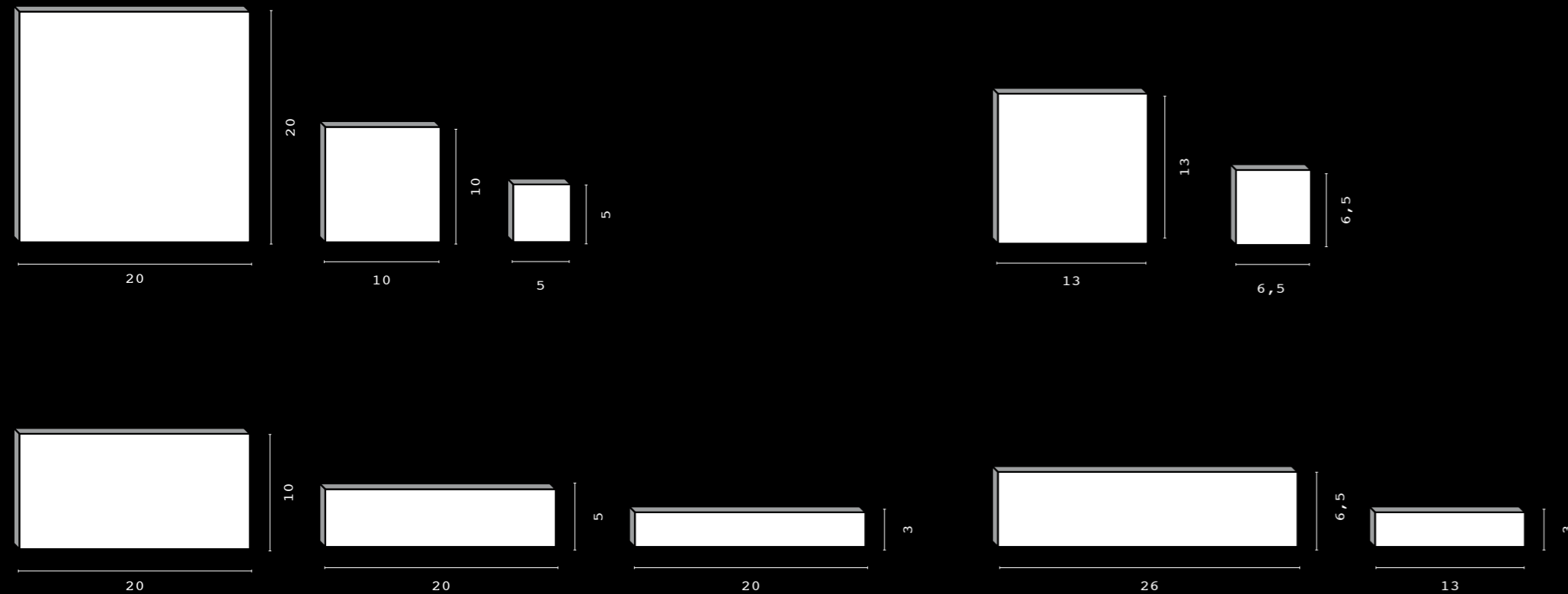

Tutti i formati hanno uno spessore di 10mm
The thickness of each size is 10mm

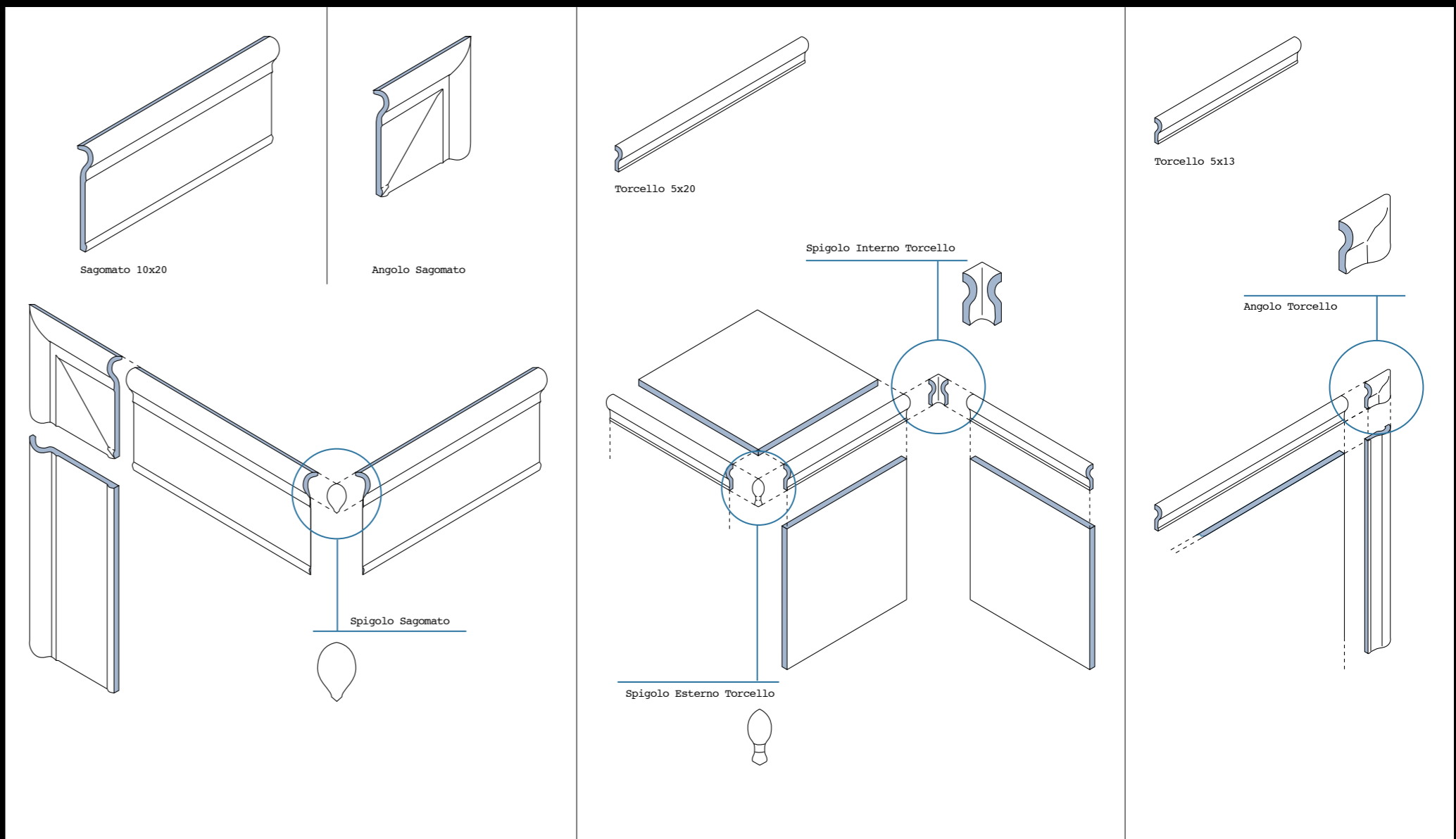

Sezione Tecnica - Technical Section.

Formati. Pezzi Speciali. Schemi di Montaggio. Lavelli. Lavabi. Gocciolatoi. *Formats. Trims. Installation diagrams. Sinks. Washbasins. Drainboards.*

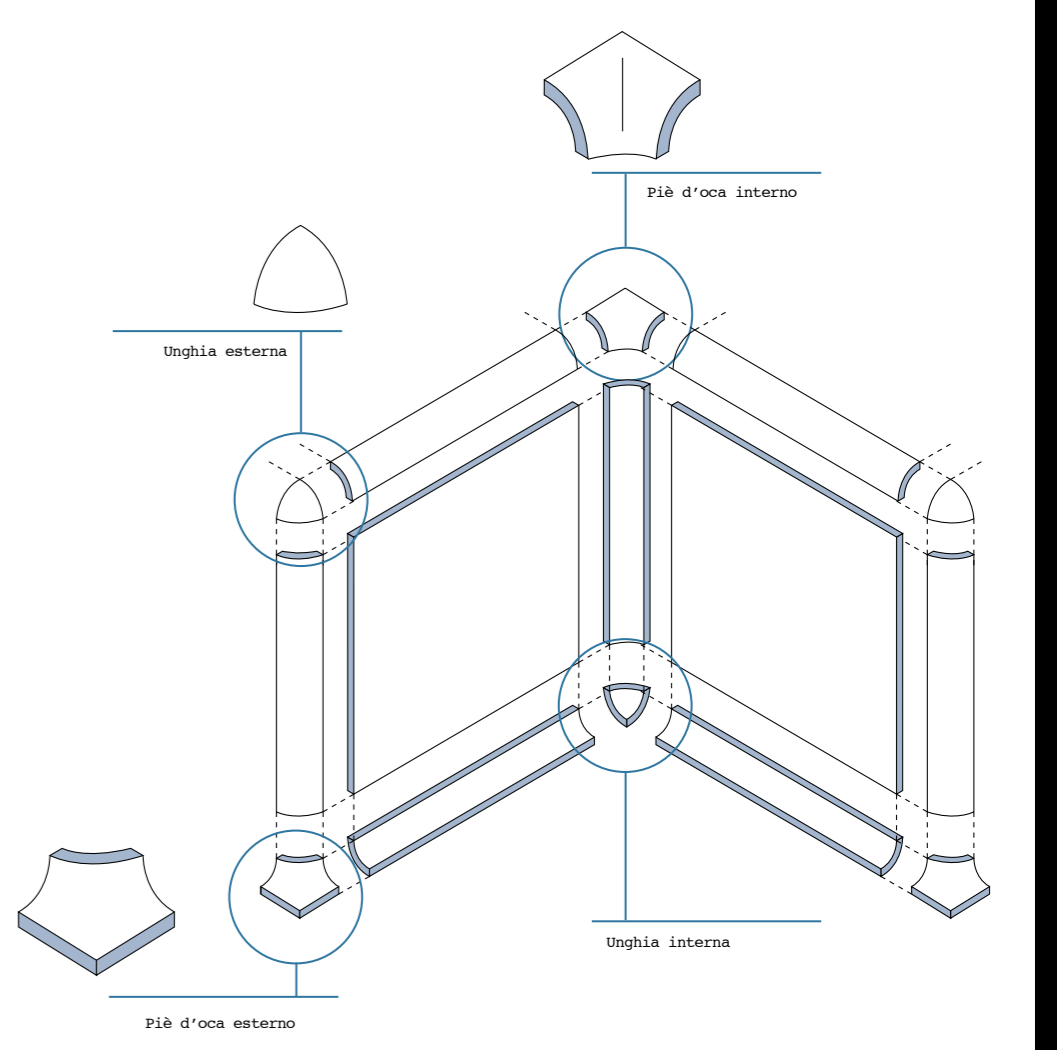
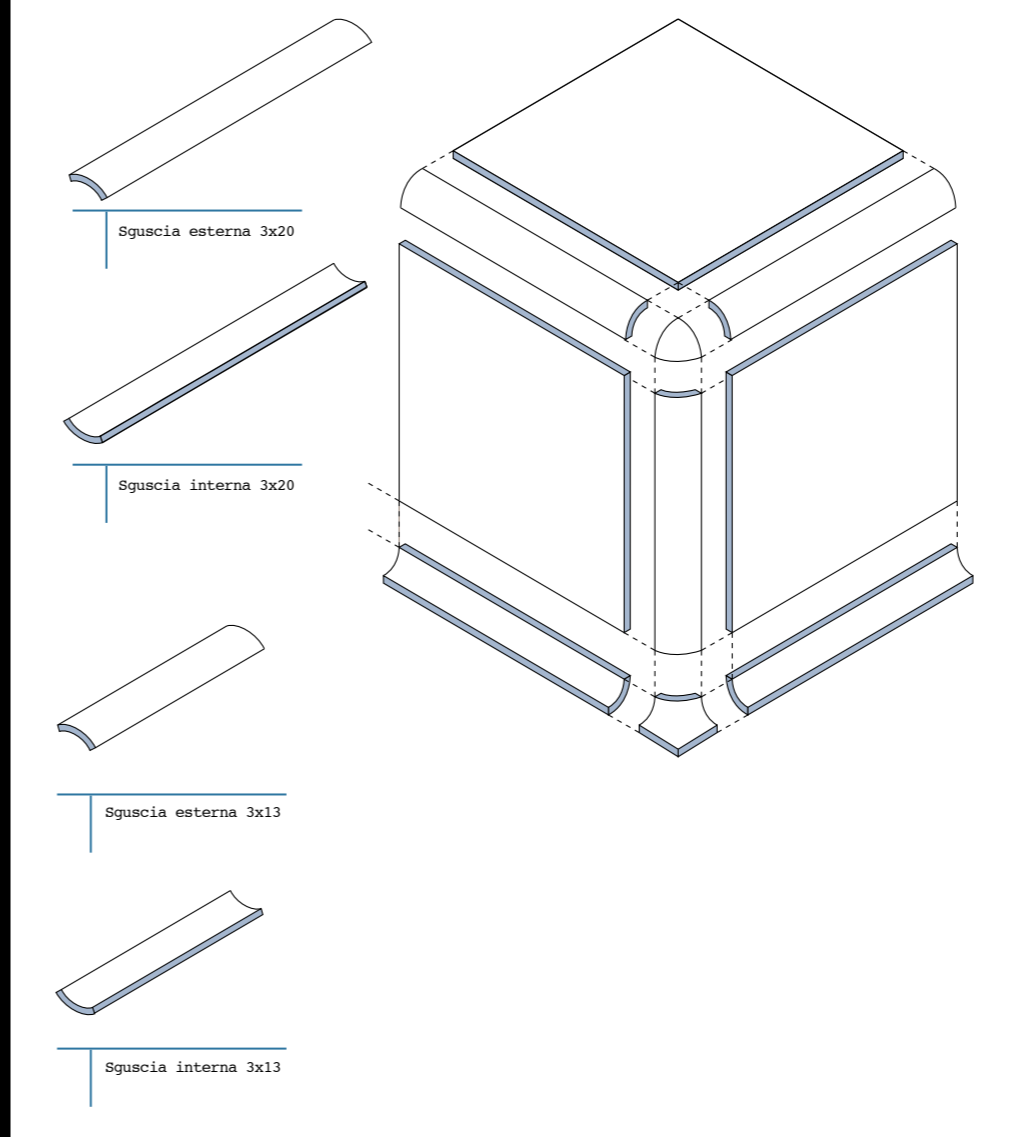
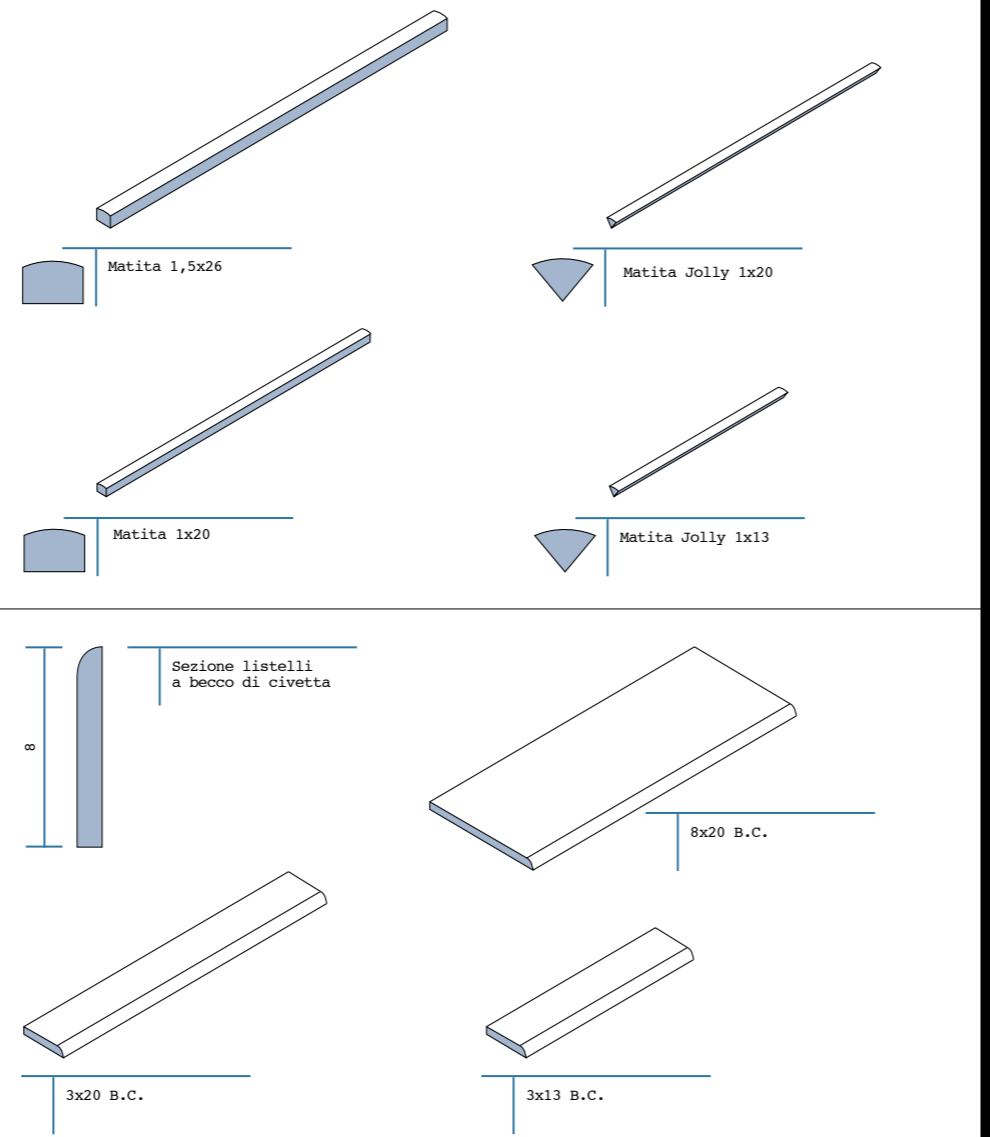
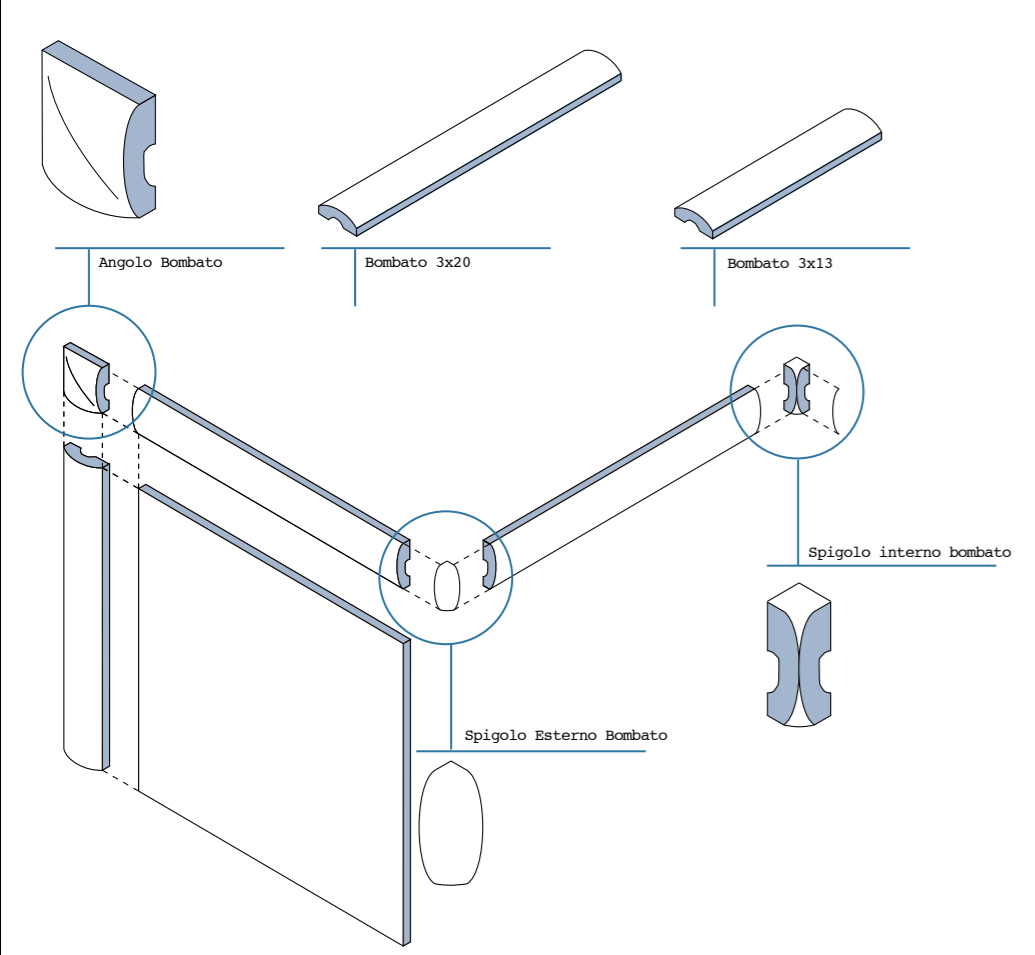

L'antica arte di preziosa materielle fatta a mano. The ancient art of fine handmade tiles.

Sezione Tecnica - Technical Section.

Formati. Pezzi Speciali. Schemi di Montaggio. Lavelli. Lavabi. Gocciolatoi. *Formats. Trims. Installation diagrams. Sinks. Washbasins. Drainboards.*

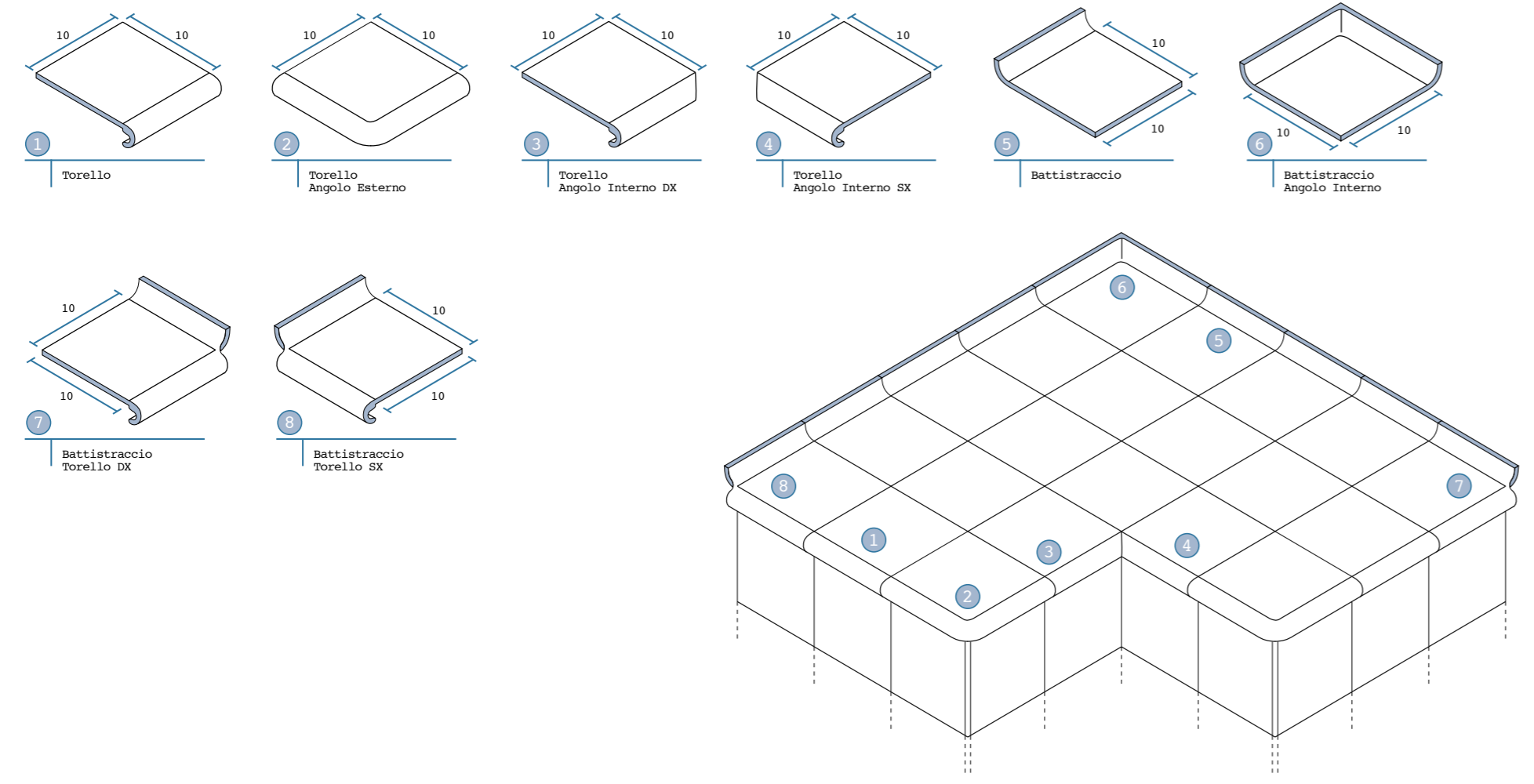

I pezzi speciali possono avere variazioni di tono rispetto alle piastrelle abbinatae.
Trims may present variations in tone compared to the tiles with which they are matched.

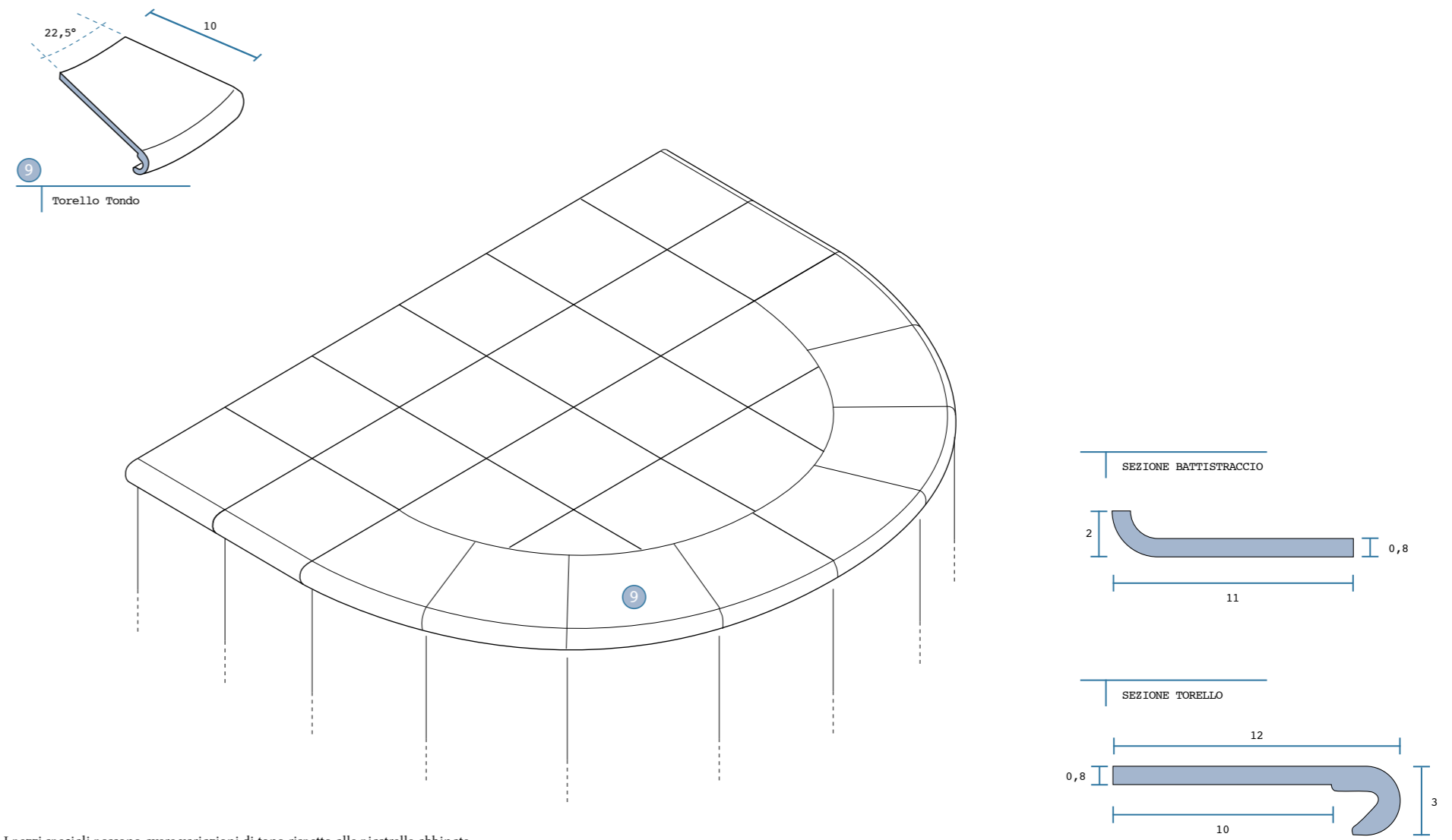

I pezzi speciali possono avere variazioni di tono rispetto alle piastrelle abbinatae.
Trims may present variations in tone compared to the tiles with which they are matched.

L'antica arte di preziose materielle fatta a mano. The ancient art of fine handmade tiles.

Sezione Tecnica - Technical Section.

Formati. Pezzi Speciali. Schemi di Montaggio. Lavelli. Lavabi. Gocciolatoi. *Formats. Trims. Installation diagrams. Sinks. Washbasins. Drainboards.*

LAVELLO QUADRATO DA INCASSO

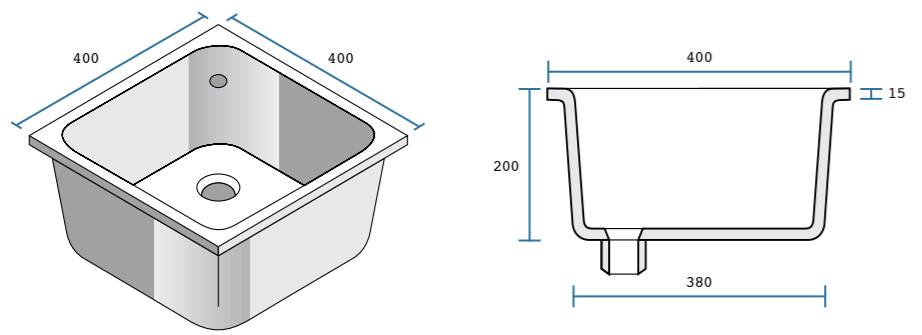

LAVELLO QUADRATO DA APPOGGIO

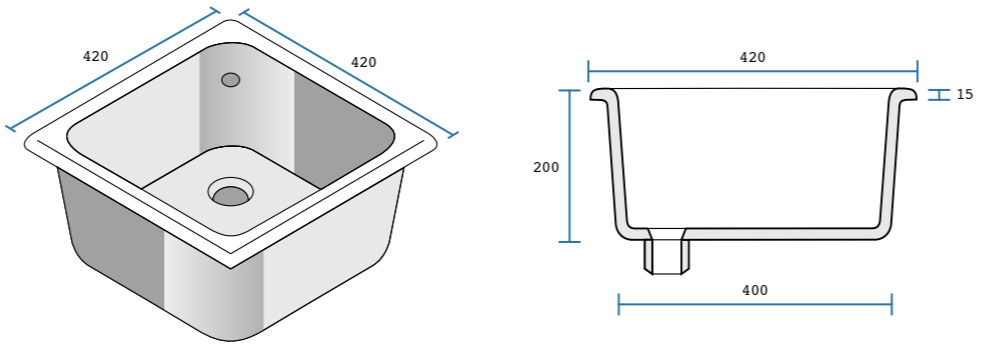

GOCCIOLATOIO QUADRATO DA INCASSO

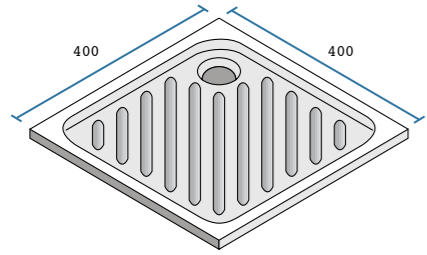

GOCCIOLATOIO QUADRATO DA APPOGGIO

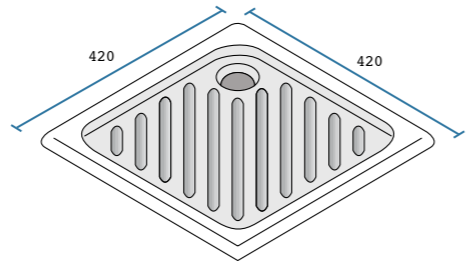

LAVELLO ROTONDO DA APPOGGIO

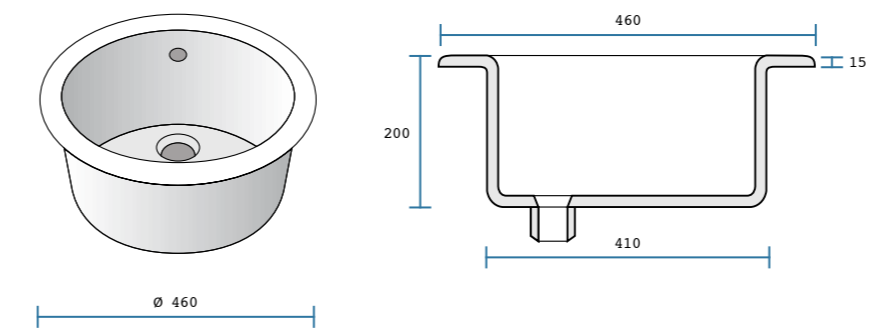

GOCCIOLATOIO ROTONDO DA APPOGGIO

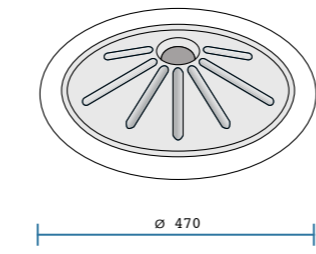

LAVABO CATINO ROTONDO DA APPOGGIO

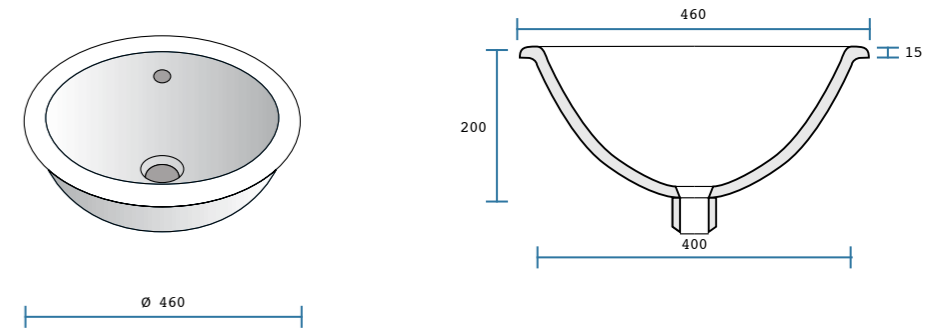

LAVABO CATINO OVALE DA APPOGGIO

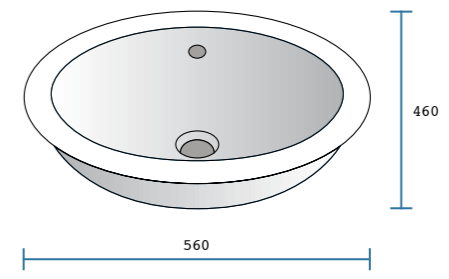

L'antica arte di preziosa materielle fatta a mano. The ancient art of fine handmade tiles.



Fasce prezzo pezzi speciali - *Price ranges of trims*

	BIANCO VIETRI	PENNELATO	SPUGNATO	DECORATO
10x20 Listello Sagomato	L50	L70	L75	L85
Spigolo Sagomato	Z22	Z24	Z26	-
Angolo Sagomato	Z27	Z29	Z30	Z33
Torcello 5x20	Z18	Z27	Z29	Z34
Angolo Torcello 5x20	Z23	Z29	Z31	Z37
Spigolo Torcello est/int 5x20	Z23	Z29	Z31	Z37
Bombato 3x20 - 3x13	Z16	Z21	Z25	Z31
Angolo Bombato 3x20 - 3x13	Z23	Z25	Z27	Z29
Spigolo Bombato est/int 3x20 - 3x13	Z23	Z25	Z27	Z29
1x20 - 1,5x26 Matite	Z16	Z21	Z25	Z31
1x20 - 1x13 Matita Jolly	Z18	Z23	Z27	-
8x20 - 3x20 - 3x13 Battiscopa	L35	L50	L55	L75
3x20 - 3x13 Sgusce est/int	Z16	Z21	Z23	Z31
Unghia/Piè d'oca est/int	Z23	Z25	Z27	Z33
10x10 Serie Torelli	Z30	Z32	Z34	Z40

Fasce prezzo 30x30 (formato fuori catalogo) - *Price ranges of 30x30 (format not included in the catalogue)*

BIANCO VIETRI	Q103
PENNELATO	Q128
SPUGNATO	Q138
I FESTONI (decoro ad angolo)	Z70
Amalfi	Q228
Appia	Q148
Barocchetto	Q228
Barocco Cerchio Rosso	Q228
Casamicciola	Q228

Fiore stilizzato	Q148
Gloria	Q148
Linda	Q148
Maria Teresa	Q148
Santa Lucia	Q148
Serto Circolare	Q148
Tulipani	Q148
Valeria	Q148



Fasce prezzo decori - *Price ranges of decorations*

(del Cotto Salernitano su Ceramica Artistica Vietrese)

(of the Cotto Salernitano on Ceramica Artistica Vietrese)

10x10 . 4x4 inc.

Cipride (greca ed angolo)	Z23
Circe (greca ed angolo)	Z23
Cnosso (greca ed angolo)	Z23
Egeo (decoro)	Q188
Egeo (greca ed angolo)	Z23
Galassia (decoro)	Q188
Galassia (greca ed angolo)	Z23
Pleiadi (greca ed angolo)	Z23
Rodi (decoro)	Q103
Rodi (greca ed angolo)	Z23
Tracia (decoro)	Q188
Tracia (greca ed angolo)	Z23

10x20 . 4x8 inc.

Cipride	L85
Circe	L85
Pleiadi	L85
Angolo su formato 10x10	Z23

10x20 sagomato . 4x8 inc. shaped

Cipride	L90
Circe	L90
Pleiadi	L90
Angolo su formato 10x10	Z37

20x20 . 8x8 inc.

Cipride (greca ed angolo)	L70
Circe (greca ed angolo)	L70
Pleiadi (greca ed angolo)	L70

PER TUTTI I PRODOTTI

Taglio di un lato a Jolly	Z1
Un lato smaltato	Z6
Taglio a 45°	Z3
Un lato a becco di civetta	Z8
Imballo su palletts	Z34 (netto)
Gabbie in legno	Z11 (netto)



Ricerca e Sviluppo: Giovanni De Maio
Marketing: Antonio De Maio . Marco De Maio . Domenico De Maio
Produzione: Elio De Maio
Customer Service: Daniela Barbara
Amministrazione: Luigi Cuoco . Patrizia Troiano . Monica De Maio
Grafica e coordinamento di produzione: Omniadvert SpA
Fotografie: Gino Di Maggio
Stampa: La Moderna (NA)

Giovanni De Maio



GIOVANNI DE MAIO SRL - Via Cervito 33 - 84084 Fisciano (SALERNO) ITALY - Tel. +39.089.826169 PBX - Fax +39.089.879408
www.giovanidemaio.com - info@giovanidemaio.com

