

Giovanni De Maio

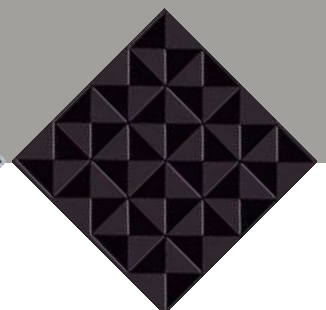

I CHIARO SCURI

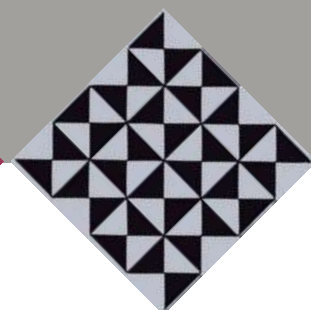
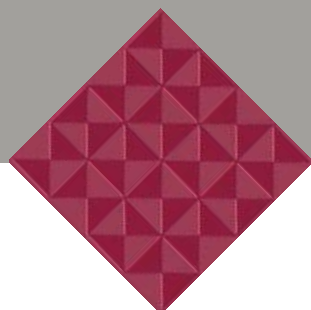

RIFLESSI MEDITERRANEI

Giovanni DeMaio

te non resistete
ele con le vostre dita, se
oso del decoro in rilievo, sentite
el Bello.

E' un'esperienza di ricordi e colori. Un susseguirsi di immagini mediterranee, di ricami e segni di ieri rivisitati con la sensibilità del nostro tempo.

La tridimensionalità delle forme gioca con la tridimensionalità delle emozioni: ceramiche belle da vedere, da toccare, da vivere.

Perché è di ceramiche che stiamo parlando, ma sarebbe più esatto dire prodotto esclusivo.

If you look at them, you will not resist, you will want to touch them.

Feel them with your fingers, follow the winding path of the relief decoration, feel the pleasure of Beauty.

Let yourself be surprised by the pleasure of discovery.
It is an experience of memories and colours, a succession of Mediterranean images, with memories and signs of the past, reinvented with the sensibility of our times.

The three-dimensionality of shapes plays with the three-dimensionality of emotions:
Yes, we are talking about tiles, more precisely about an exclusive product.

Попробуйте придвинуть два элемента к себе эту последовательность в большом пространстве. Результат удивительный и гармоничный. Они одновременно и гармонично старинные.

I Chiaroscuri
sнова "пр
среди
в но
R

02

Lasciatevi sorprendere dal piacere della scoperta

Se le **guardate** non resisterete, vorrete toccarle.



Sfioratele con le vostre dita,
seguite il percorso sinuoso del decoro in rilievo,
sentirete il piacere del Bello.

È un'esperienza di **ricordi** e colori.

Un susseguirsi di **immagini**
mediterranee, di richiami a segni di ieri

rivisitati con la sensibilità del nostro **tempo**



La bellezza si contempla, si esalta, si ammira.
Ora potete toccarla con mano.

Il **colore** ha carattere,
comunica sensazioni, influenza piacevolmente la nostra quotidianità.

Ventuno colorazioni base.

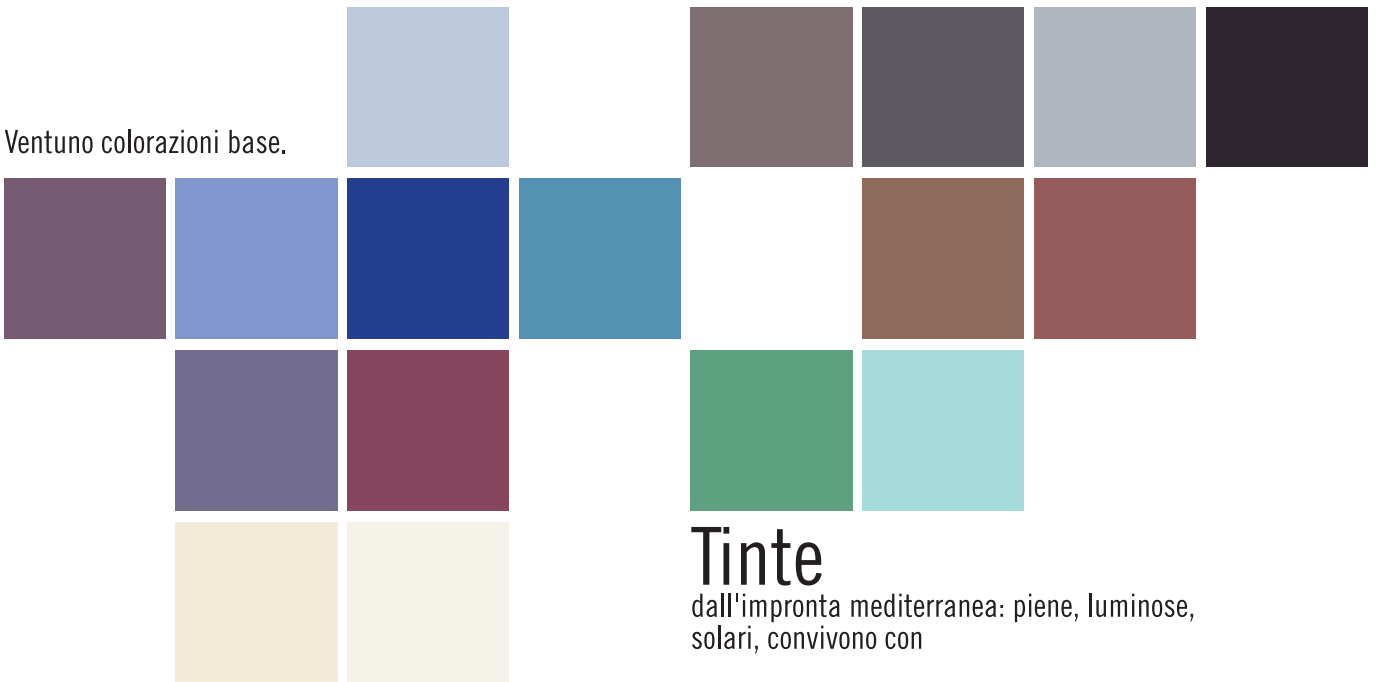

Tinte

dall'impronta mediterranea: piene, luminose,
solari, convivono con

nuances

aromatiche di spezie, essenze, frutti maturi.



Accanto a queste, colorazioni metropolitane, calde
nella loro freddezza, contemporanee, forti, ricche.

Ne IChiaroscuri Giovanni De Maio
ogni colore racconta una storia.

Giovanni De Maio

If you look at them, you will not resist, you will want to touch them.

Feel them with your fingers, follow the winding path of the relief decoration, feel the pleasure of Beauty.

04

Let yourself be surprised by the pleasure of discovery. It is an experience of memories and colours, a succession of Mediterranean images, with memories and signs of the past, reinvented with the sensibility of our times.

The three-dimensionality of shapes plays with the three-dimensionality of emotions: tiles beautiful to see, to touch and to live. Yes, we are talking about tiles, more precisely about an exclusive product.

I Chiaroscuro De Maio are unique, unrepeatable pieces, handcrafted, one by one, with passion and skill.

Shapes, shades and patterns to be combined and arranged to tailor one's own taste and style. But not only.

I Chiaroscuro is a decor that creates unique and unrepeatable environments.

A versatile collection that opens up new avenues of creativity, able to combine fantasy and style. This is the new vision of elegant spaces, of environments that are open to the joy of living.

The beauty admires and celebrates itself. Now you can touch it.

21 colours EN



Tone-on-tone, opaque background, decoration in shiny relief. The light plays with the textures of the lines, enhances the shadows and curves giving a new vision to each new look.

Try to put two elements together and imagine this sequence that is repeated in a wide space. Our eyes are caught by the spirals, leaves, geometric lines endlessly chasing each other.

Traits that are so archaic and modern at the same time, all exclusive.

In De Maio I Chiaroscuro the decorations of the most ancient Mediterranean tradition come alive in a new version, simple and linear.

An embroidery that is rich because it is unadorned, elegantly bare. Definitely precious in its sobriety.

The overall result is surprising for the harmony of design that gradually develops in manifold variations.



Попробуйте придвинуть два элемента и представить себе эту последовательность в большом пространстве. Результатом будет удивительный и гармоничный ансамбль во всех своих вариациях. Все изображения эксклюзивны. Они одновременно современные и в то же время старинные.

I Chiaroscuro нашей фабрики дарят возможность снова "прожить" декоры старинной средиземноморской традиции в новом, линейном ключе. В то же время эта плитка как дорогая и прекрасная вышивка, поражающая своей простотой.

21

21 RUCOLOURS

Раздел, посвященный цветам

Свет отражается в богатых красках и воспламеняется в контрастах. Он создает магию цветов. Цвета обогащают формы, а формы - пространство. Цвет, передающий ощущения, благотворно влияет на нашу жизнь.

Существует 21 основных окрасок.

Это средиземноморские цвета, полные света и солнца.

В наличии есть также городские, современные, сильные и богатые цвета.

В Chiaroscuro De Maio каждый цвет рассказывает свою историю.

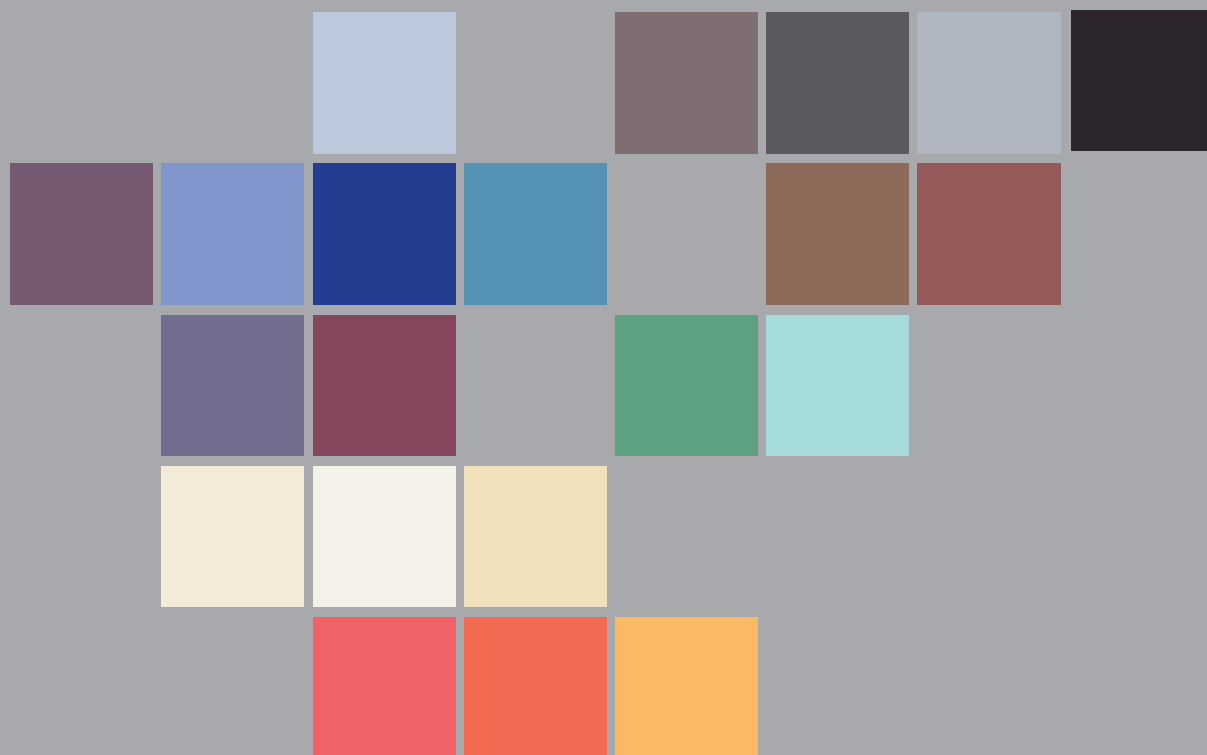

I Chiaroscuro Giovanni De Maio

При взгляде на эту плитку Вы не сможете устоять перед тем, чтобы до нее дотронуться.

Это незабываемый опыт погружения в цвета, череду средиземноморских изображений, в отражение прошлого, переосмысленного через чувствительность нашего времени.



Трехмерность форм играет с трехмерностью эмоций:

на эту плитку приятно смотреть, до нее приятно дотрагиваться, с ней приятно жить.

Это эксклюзивный продукт.

I Chiaroscuro фабрики Giovanni De Maio это уникальная плитка, произведенная ремесленным способом, одна за другой, с любовью и мастерством, среди которой Вы можете найти различные формы, тона и декоры, которые впоследствии скомбинируете согласно Вашему вкусу и стилю.

I Chiaroscuro

это универсальная коллекция, открывающая новые пути к креативности и способная объединить фантазию и стилистическую строгость.

I Chiaroscuro- это новое видение элегантности пространства, обстановка, дышащая радостью жизни, где до восхитительной красоты можно дотронуться рукой.



Pagina
Page

CENERE

26/27



CEMENTO

30/31



DORIAN

32/33



La tridimensionalità delle forme gioca con la tridimensionalità delle emozioni: ceramiche belle da vedere, da toccare, da vivere.

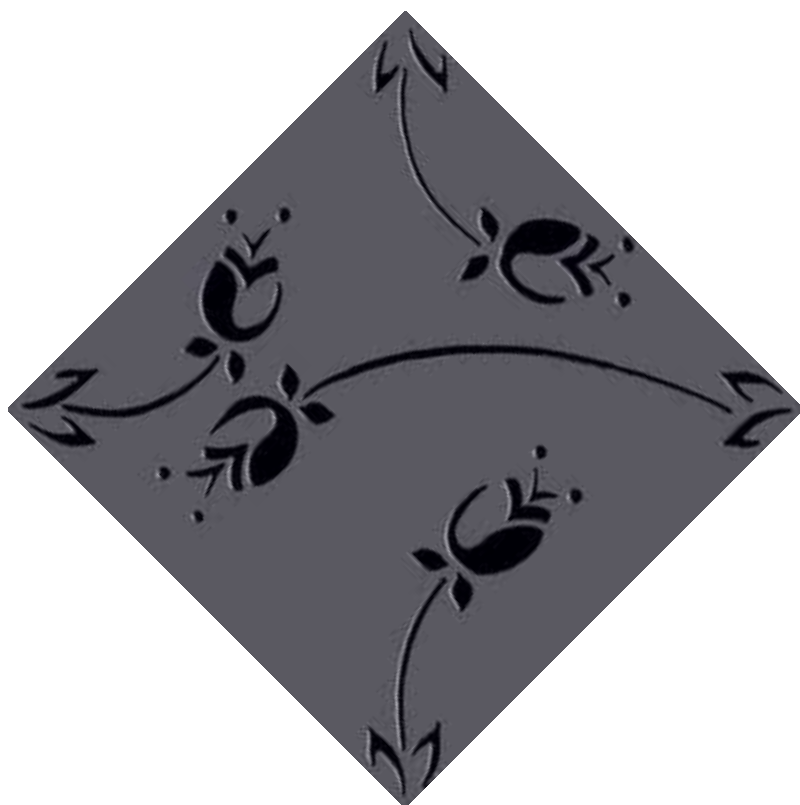

20x20



I Chiaroscuri Giovanni De Maio sono pezzi unici ed irripetibili, realizzati artigianalmente, uno ad uno, con passione e maestria.

20x60

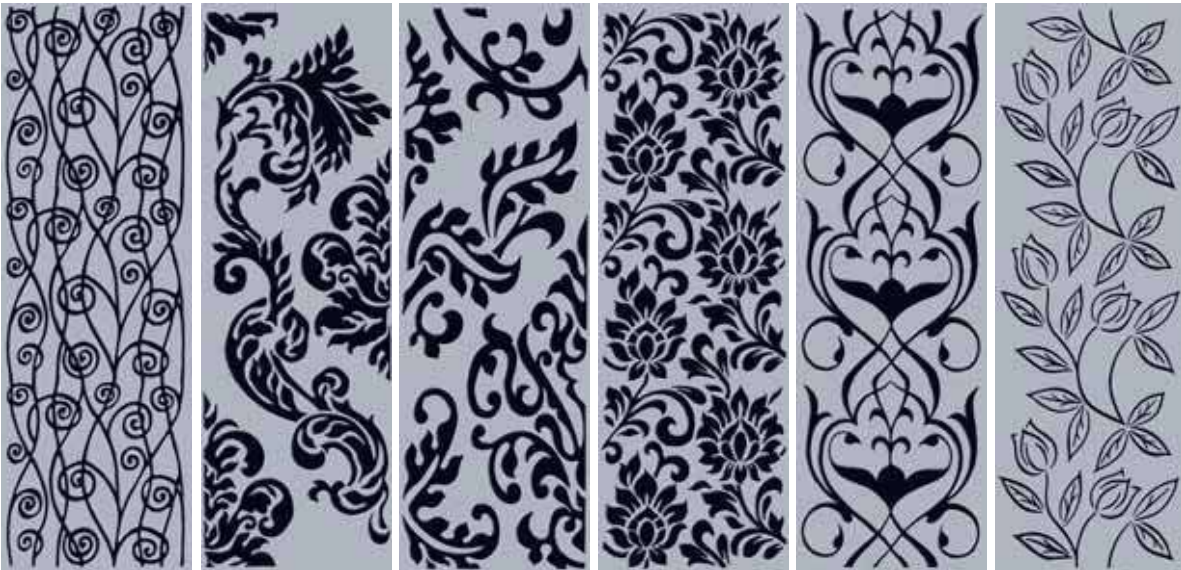

Pagina
Page

ONICE
36/37



RAME DORATO
40/41



20x20



Una collezione versatile che apre nuove strade alla creatività, capace di far convivere fantasia e rigore stilistico.



Forme, tonalità, decori, da abbinare e comporre assecondando il proprio gusto e il proprio stile. Ma non solo. I Chiaroscuri Giovanni De Maio sono oggetti di arredo che creano ambientazioni uniche ed irripetibili.

20x60



Pagina
Page

TERRA DI SIENA

42/43



CACAO

46/47



CUOIO

50/51



20x20



*È la nuova visione di spazi eleganti, ambienti
che si aprono alla gioia di abitare.*



20x60



Pagina
Page

AMARENA

54/55



PRUGNA

56/57



MELANZANA

60/61



20x20

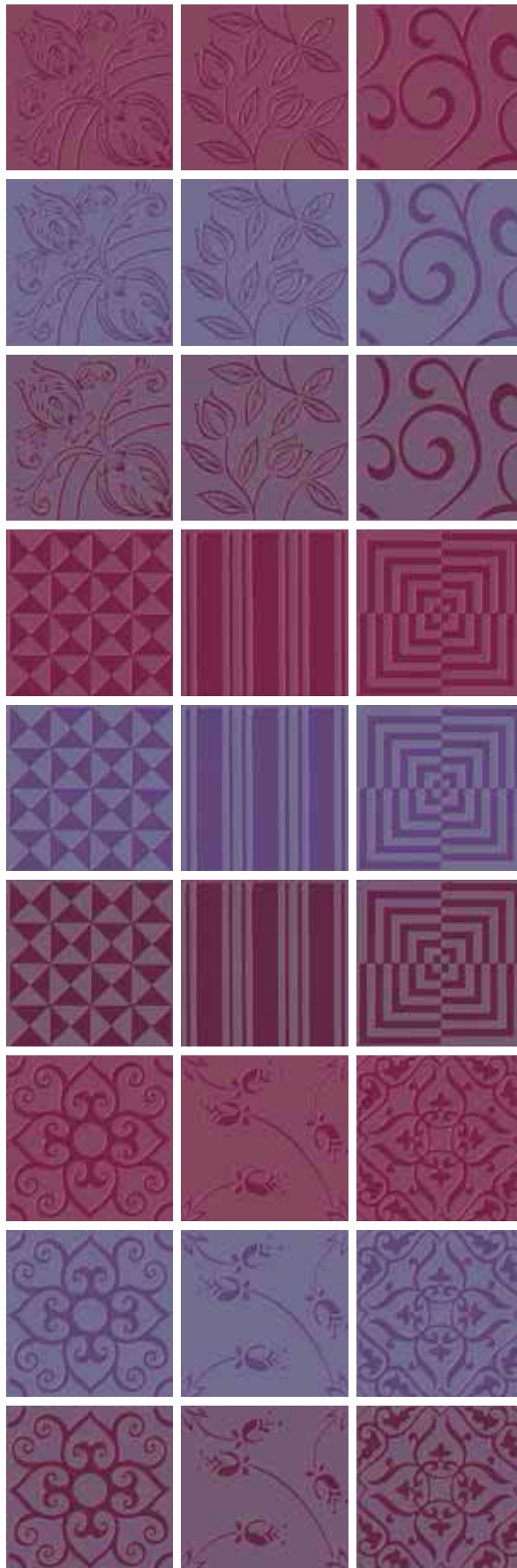

Tono su tono, fondo opaco, decoro in rilievo lucido a spessore.

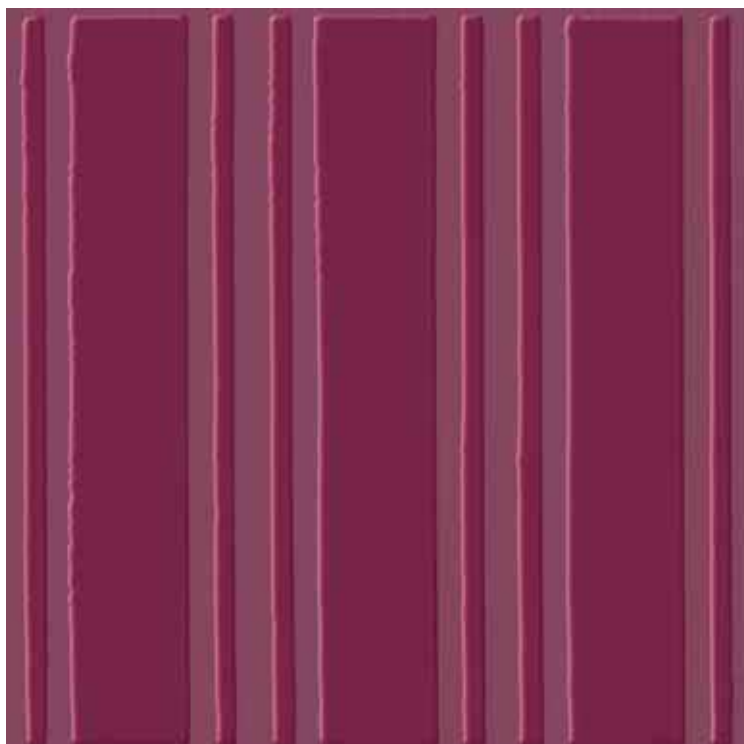

La luce gioca con le trame del segno, esalta le ombre e le curve regalando una nuova visione a ogni nuovo sguardo.

20x60

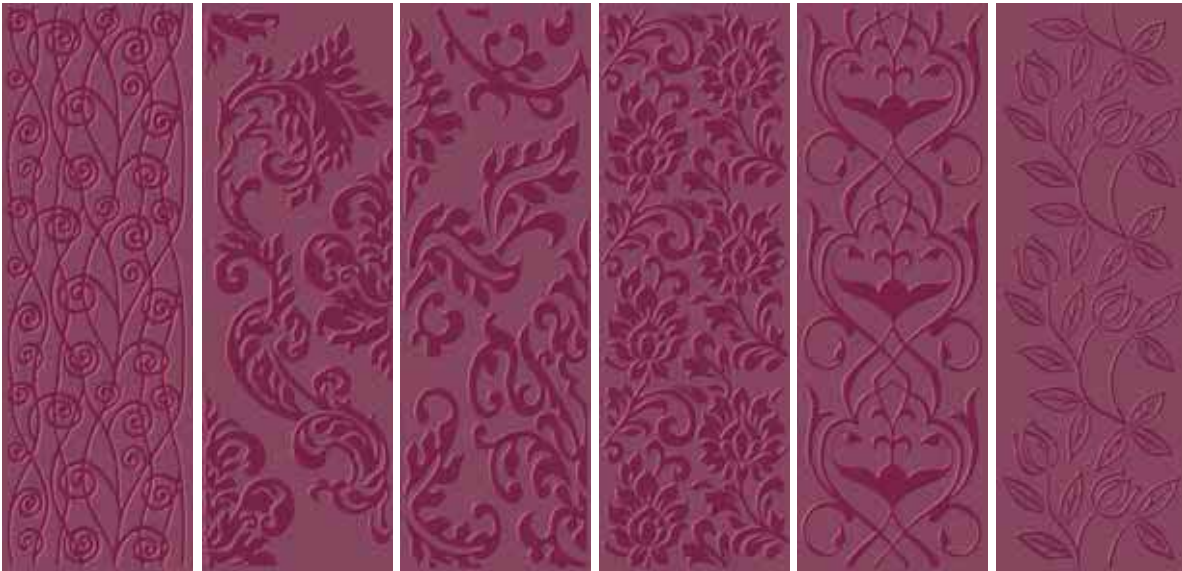

Pagina
Page

CIELO
62/63



AVION
66/67



COBALTO
70/71



20x20

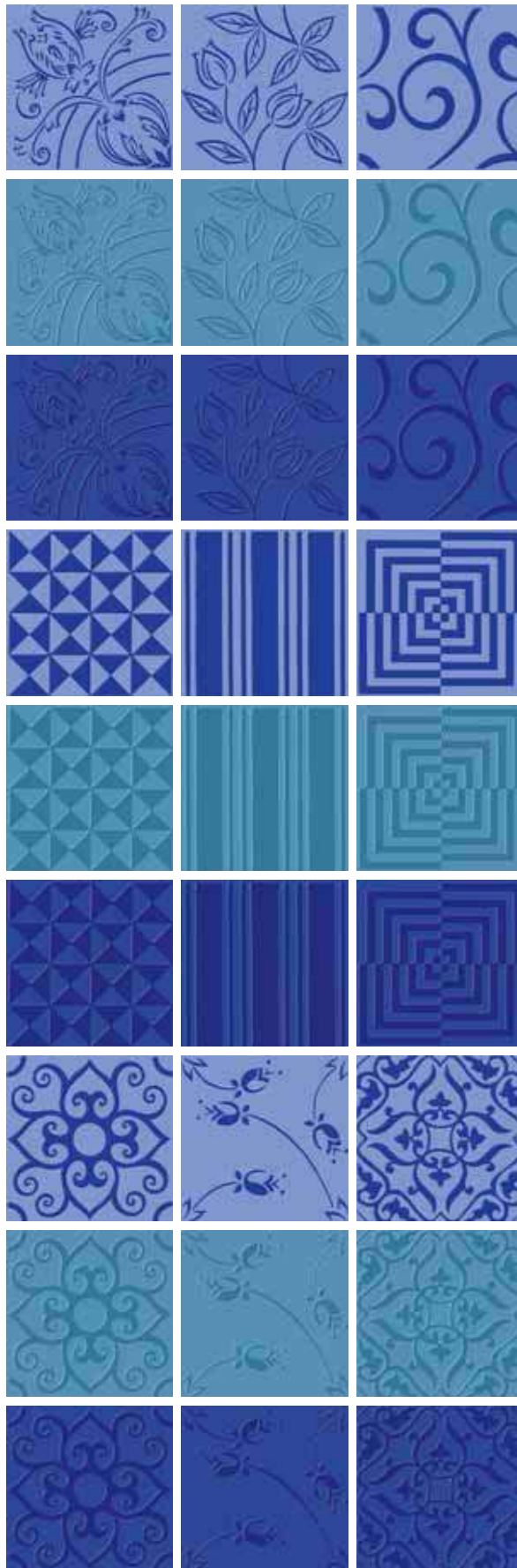

I nostri occhi sono rapiti dall'inseguirsi all'infinito di volute, sbuffi, foglie, linee geometriche.

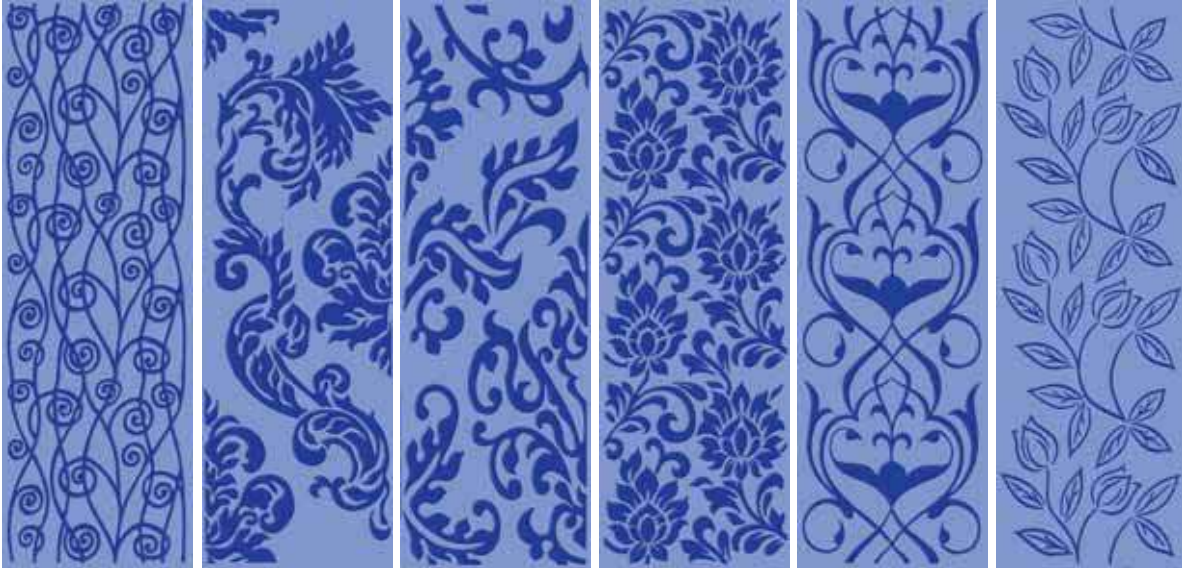

Il risultato d'insieme è sorprendente per l'armonia del disegno che via via si sviluppa nelle infinite varianti possibili.

20x60

Pagina
Page

ACQUA
76/77

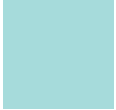

PRATO
78/79



20x20



*Tratti così moderni e al tempo stesso arcaici,
tutti esclusivi.*



Ne IChiaroscuri Giovanni De Maio i decori della più antica tradizione mediterranea rivivono in una versione nuova, essenziale e lineare.

20x60

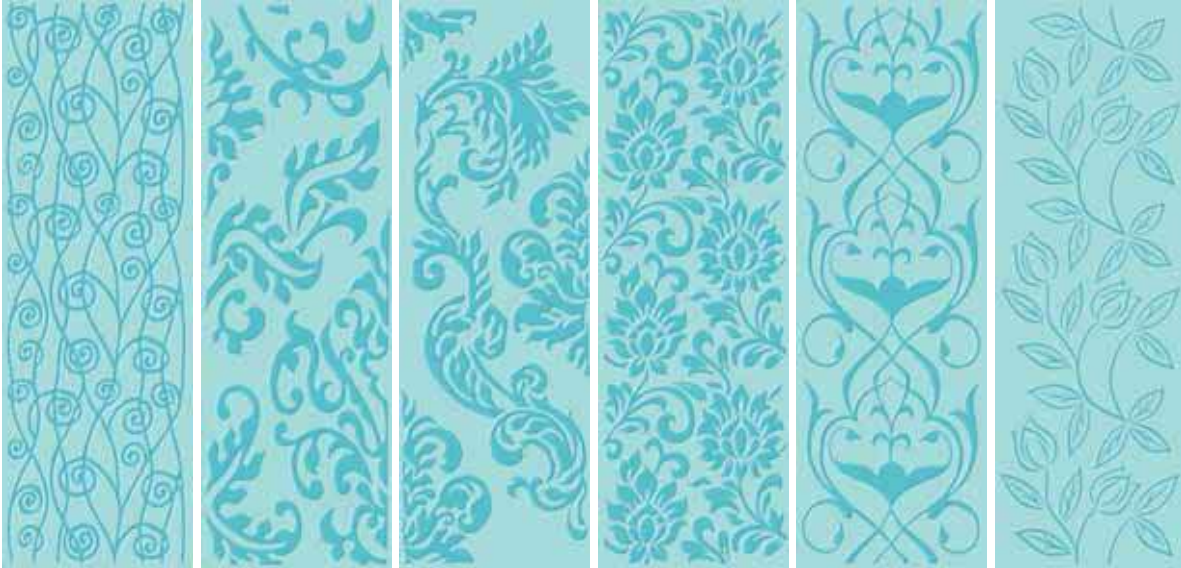

Pagina
Page

GHIACCIO
82/83

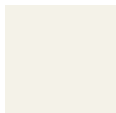

PANNA
86/87



SABBIA
88/89



20x20



*Un ricamo ricco perché disadorno,
elegantemente spoglio. Decisamente prezioso
nella sua sobrietà.*



20x60



Pagina
Page

OCRA
92/93



MANDARINO
94/95



CORALLO
98/99



20x20

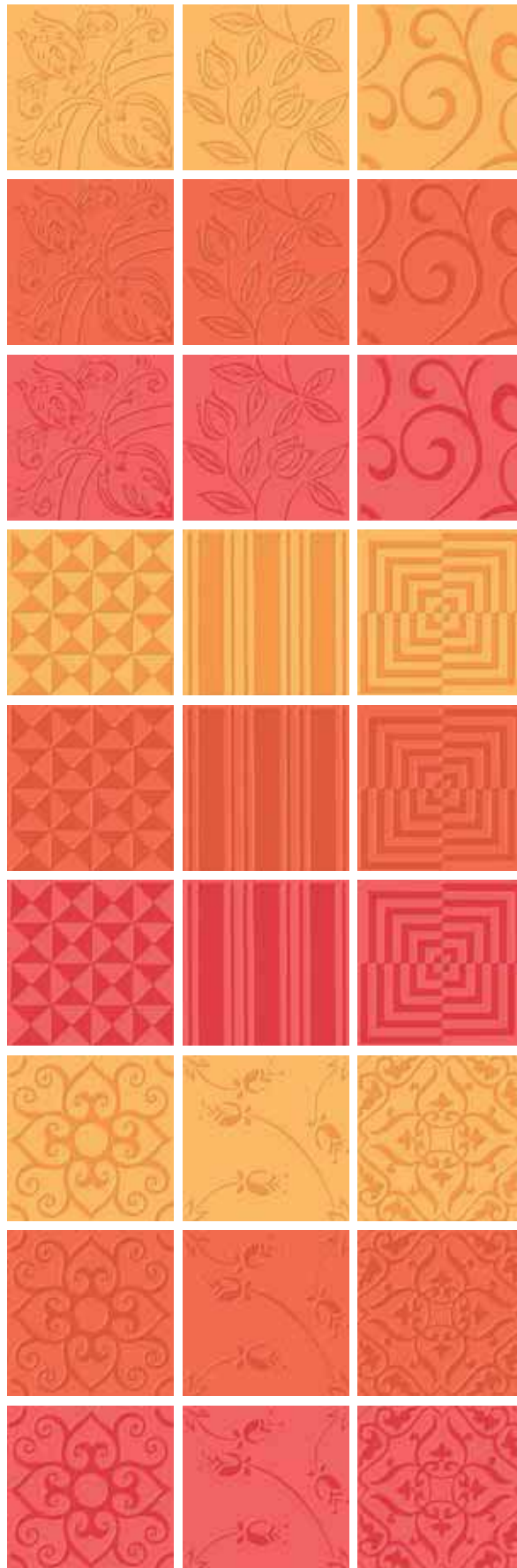

*La luce vive nella pienezza dei toni,
si esalta nel gioco dei contrasti.*



*La luce ci regala la magia del colore.
Il colore è esso stesso materia, arricchisce
le forme impreziosendo gli ambienti.*

20x60

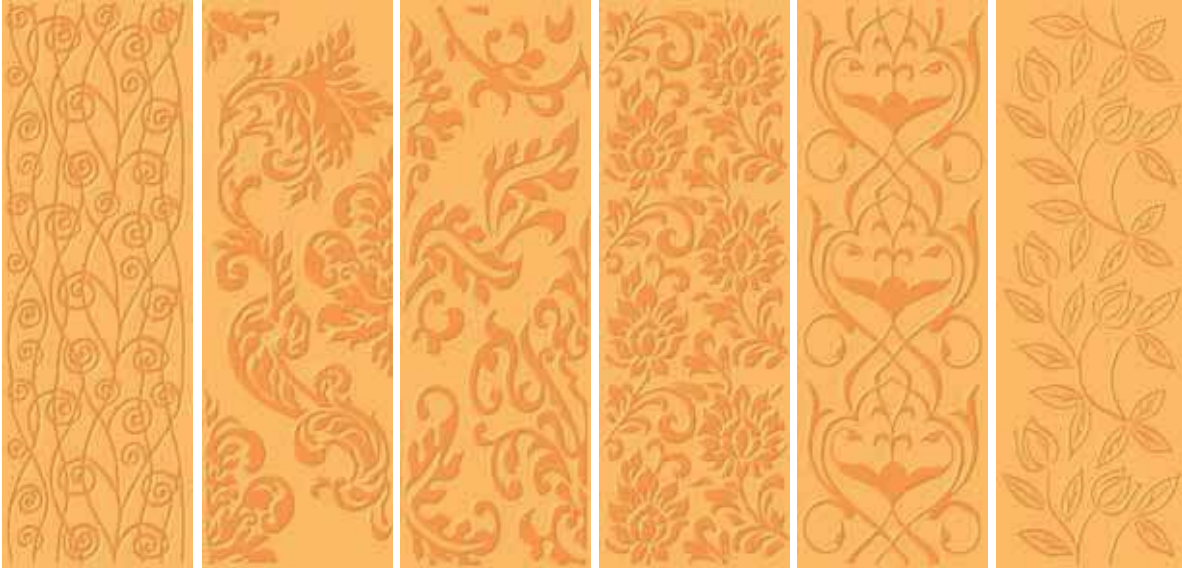





Il colore arricchisce le forme
impresiosando gli ambienti.

26



FONDO CENERE



GERMOGLIO CENERE



RUGIADA CENERE



RICCIOLI CENERE

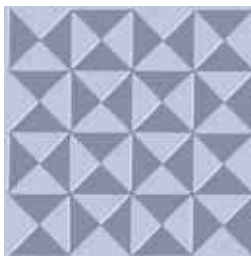

TRIANGOLI CENERE

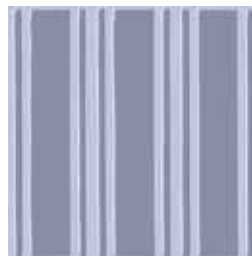

RIGHE CENERE

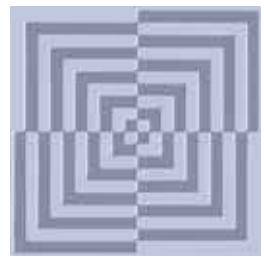

GEOMETRIE CENERE



RICAMO CENERE



BOCCILO CENERE



FILIGRANA CENERE

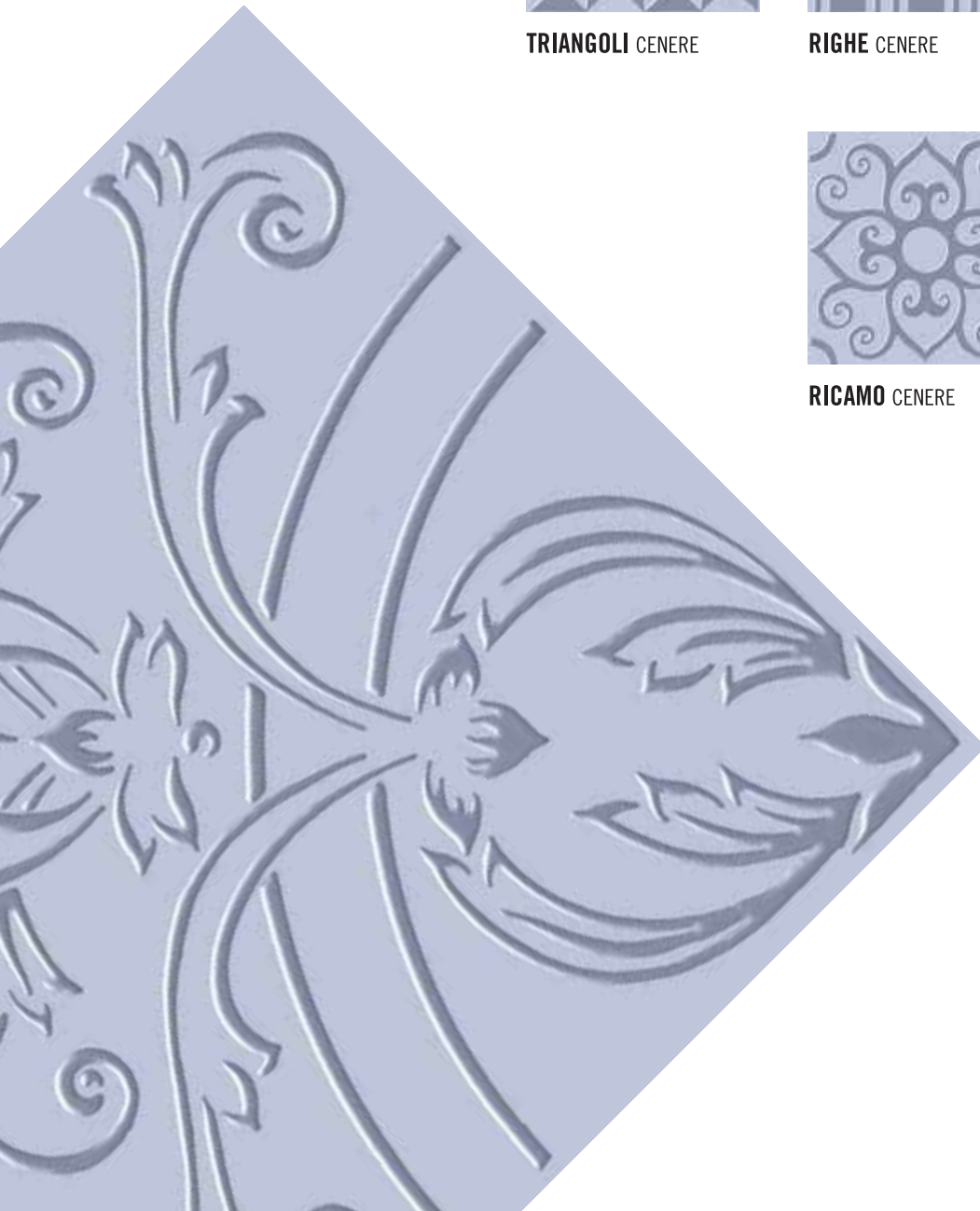

CENERE 20x60

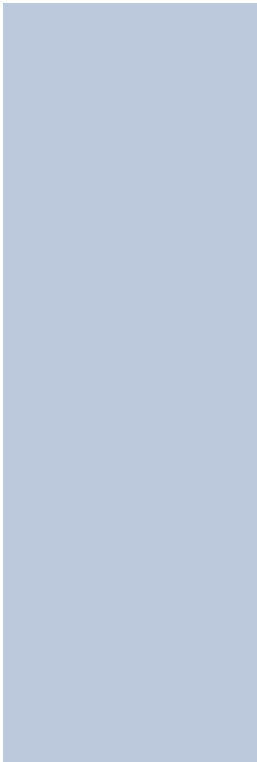

FONDO CENERE



ARABESCO CENERE



GRANDE BAROCCO CENERE



DAMASCATO CENERE



PARTENOPE CENERE



RUGIADA CENERE



TRAMA CENERE

28



FONDO CEMENTO 20x20



RIGHE CEMENTO 20x20



FONDO ONICE 20x20

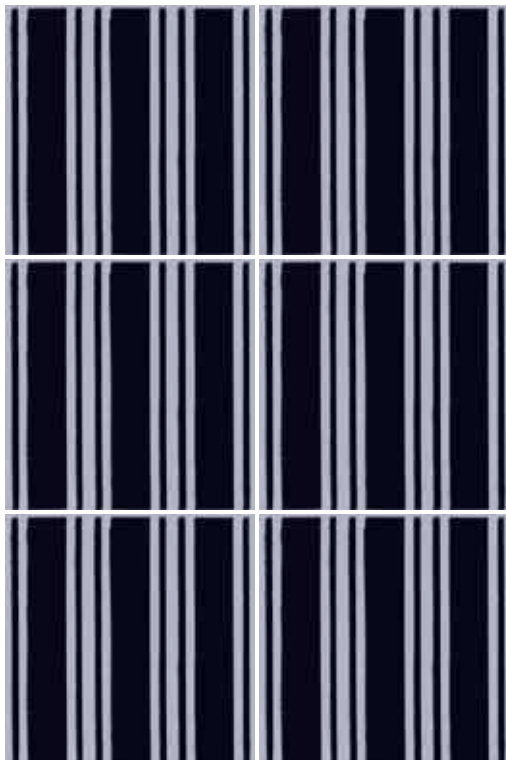



29

30

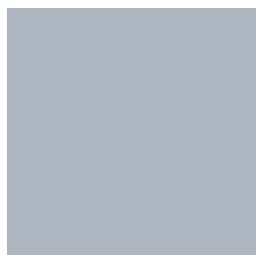

FONDO CEMENTO



GERMOGLIO CEMENTO



RUGIADA CEMENTO



RICCIOLI CEMENTO

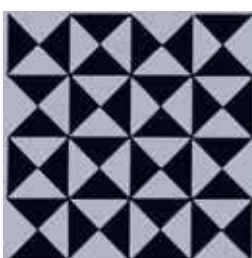

TRIANGOLI CEMENTO

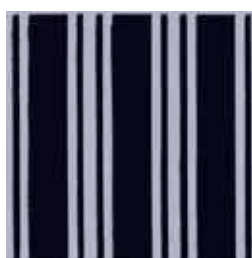

RIGHE CEMENTO



GEOMETRIE CEMENTO



RICAMO CEMENTO



BOCCILO CEMENTO



FILIGRANA CEMENTO



CEMENTO 20x60

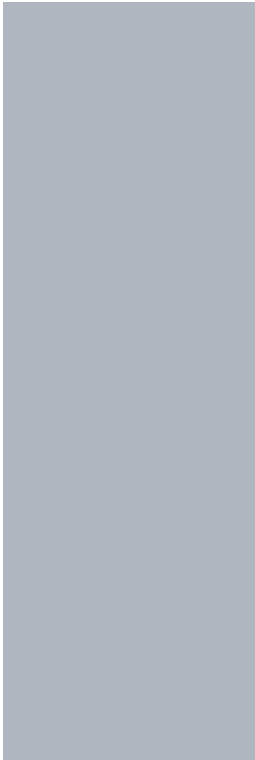

FONDO CEMENTO

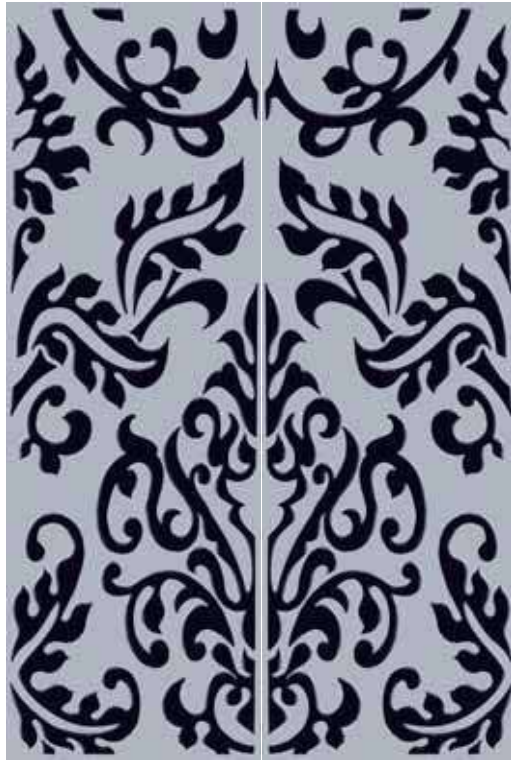

ARABESCO CEMENTO



GRANDE BAROCCO CEMENTO



DAMASCATO CEMENTO



PARTENOPE CEMENTO



RUGIADA CEMENTO



TRAMA CEMENTO

DORIAN 20x20

32



FONDO DORIAN



GERMOGLIO DORIAN



RUGIADA DORIAN



RICCIOLI DORIAN



TRIANGOLI DORIAN



RIGHE DORIAN

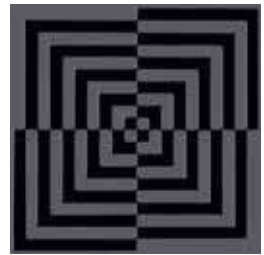

GEOMETRIE DORIAN



RICAMO DORIAN



BOCCILOLO DORIAN



FILIGRANA DORIAN

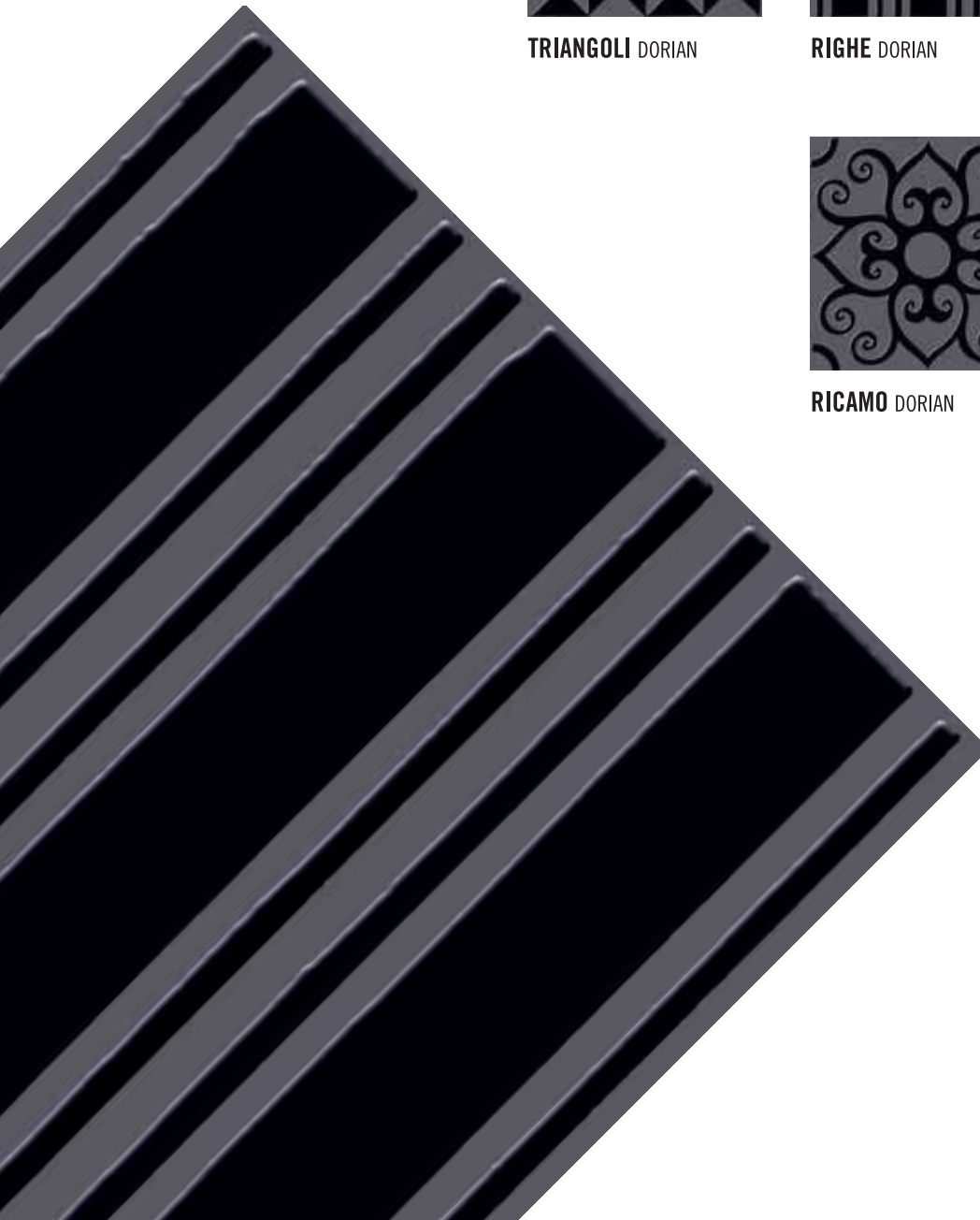

DORIAN 20x60



FONDO DORIAN



ARABESCO DORIAN



GRANDE BAROCCO DORIAN



DAMASCATO DORIAN



PARTENOPE DORIAN



RUGIADA DORIAN



TRAMA DORIAN

34



BOCCILO DORIAN 20x20



FONDO DORIAN 20x20

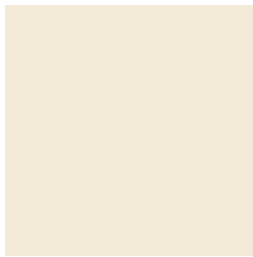

FONDO PANNA 20x20

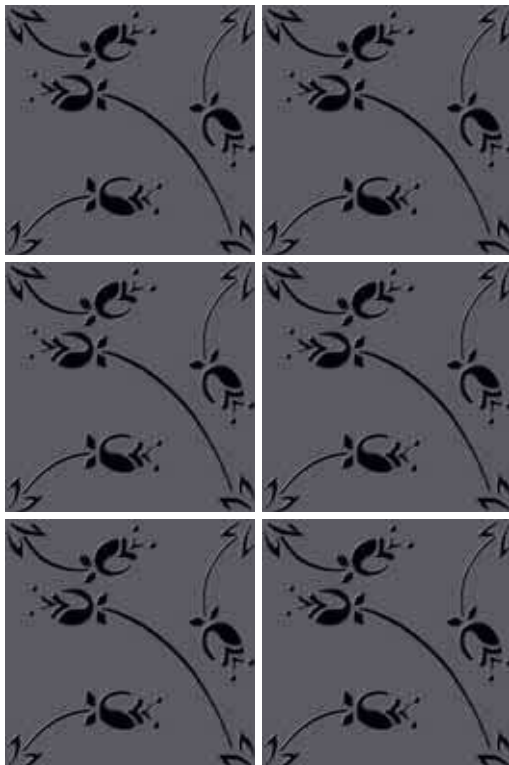



35

ONICE 20x20

36



FONDO ONICE



GERMOGLIO ONICE



RUGIADA ONICE



RICCIOLI ONICE



TRIANGOLI ONICE



RIGHE ONICE

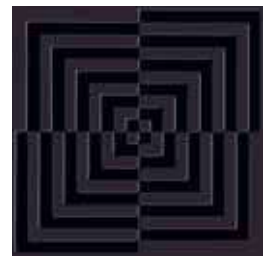

GEOMETRIE ONICE



RICAMO ONICE



BOCCILOLO ONICE



FILIGRANA ONICE

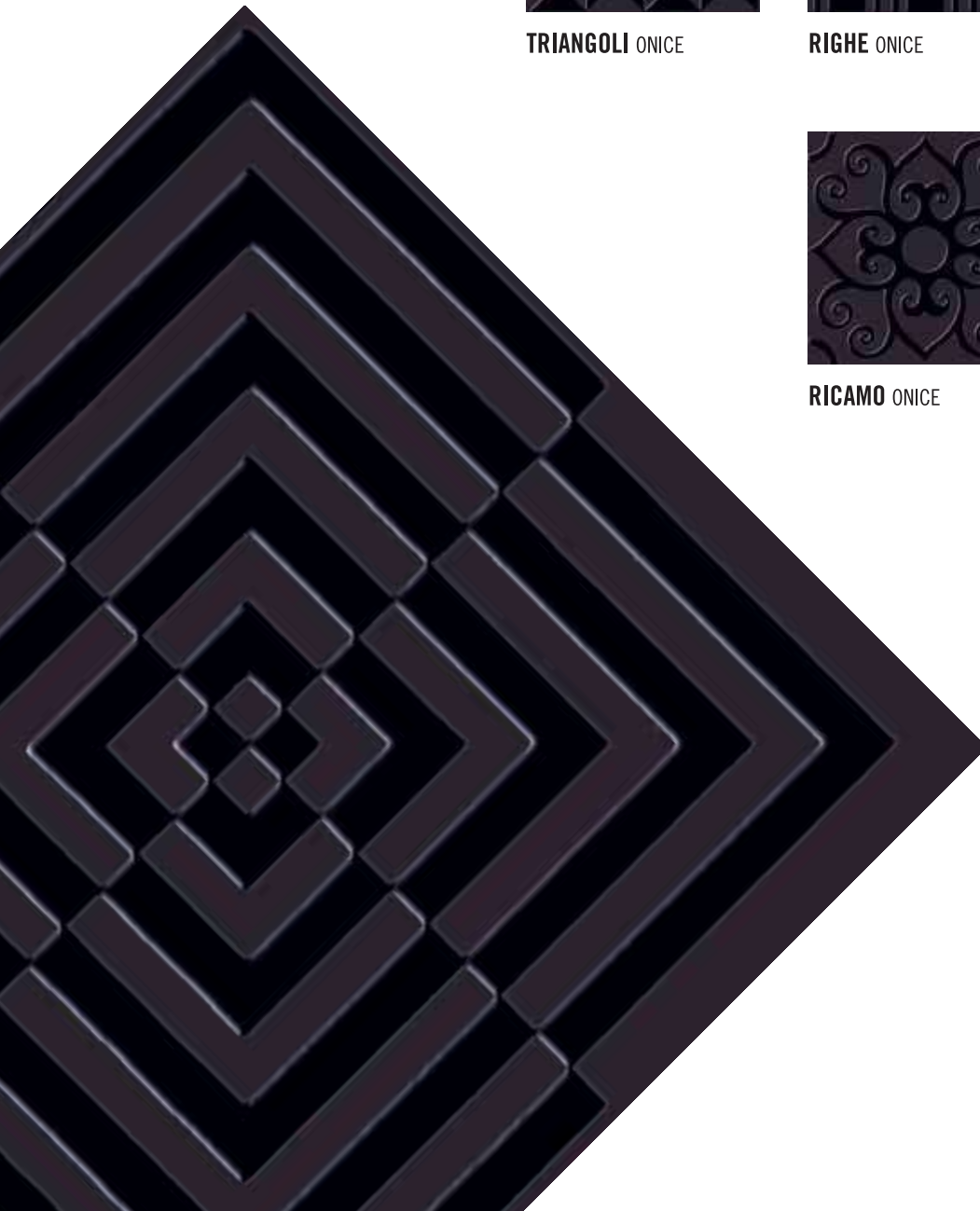

ONICE 20x60

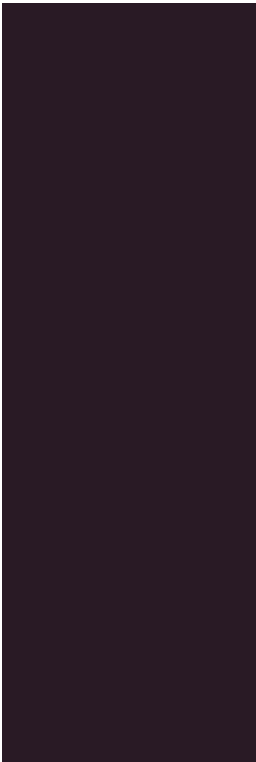

FONDO ONICE



ARABESCO ONICE



GRANDE BAROCCO ONICE



DAMASCATO ONICE



PARTENOPE ONICE



RUGIADA ONICE



TRAMA ONICE

38



PARTENOPE
RAME DORATO 20x60

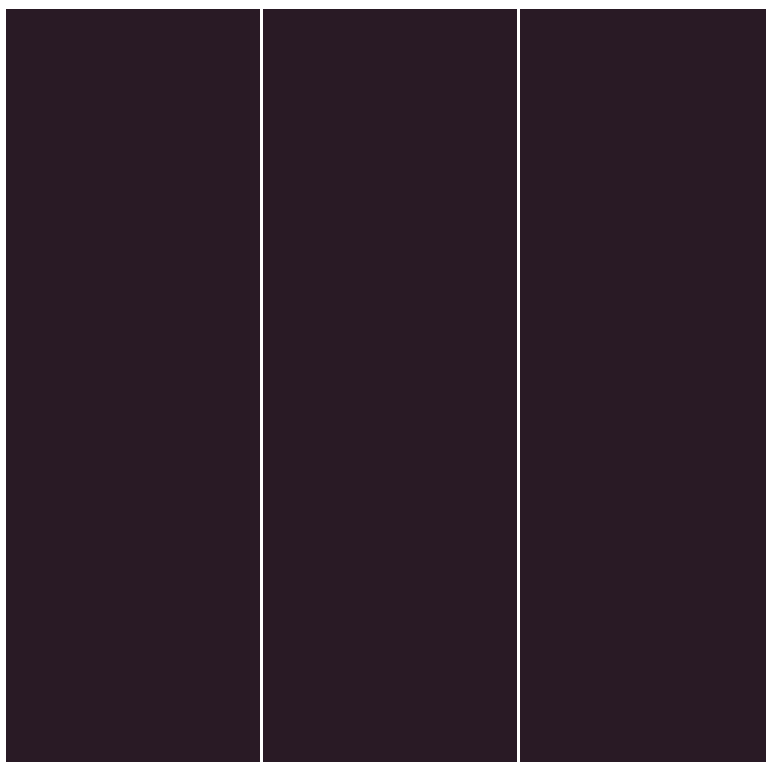

FONDO ONICE 20X60



RAME DORATO 20x20

40



FONDO ONICE



GERMOGLIO RAME DORATO



RUGIADA RAME DORATO



RICCIOLI RAME DORATO



TRIANGOLI RAME DORATO



RIGHE RAME DORATO



GEOMETRIE RAME DORATO



RICAMO RAME DORATO



BOCCILOLO RAME DORATO



FILIGRANA RAME DORATO

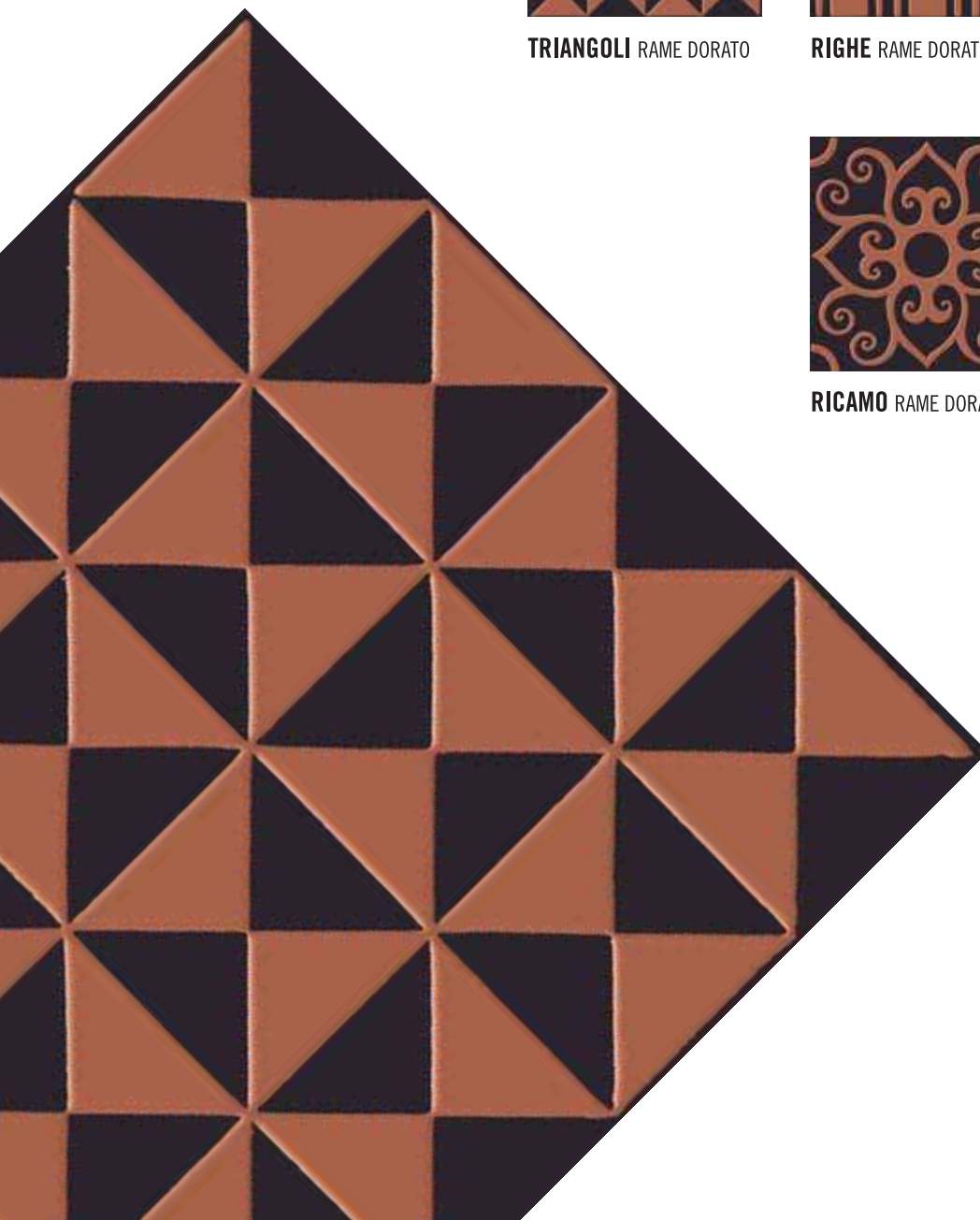

RAME DORATO 20x60

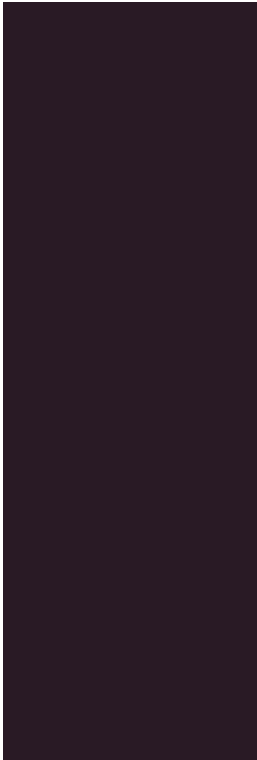

FONDO ONICE



ARABESCO RAME DORATO



GRANDE BAROCCO RAME DORATO



DAMASCATO RAME DORATO



PARTENOPE RAME DORATO



RUGIADA RAME DORATO



TRAMA RAME DORATO

TERRA DI SIENA 20x20

42



FONDO TERRA DI SIENA



GERMOGLIO TERRA DI SIENA



RUGIADA TERRA DI SIENA



RICCIOLI TERRA DI SIENA



TRIANGOLI TERRA DI SIENA



RIGHE TERRA DI SIENA

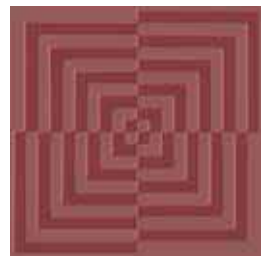

GEOMETRIE TERRA DI SIENA



RICAMO TERRA DI SIENA



BOCCILO TERRA DI SIENA



FILIGRANA TERRA DI SIENA



TERRA DI SIENA 20x60



FONDO TERRA DI SIENA



ARABESCO TERRA DI SIENA



GRANDE BAROCCO TERRA DI SIENA



DAMASCATO TERRA DI SIENA



PARTENOPE TERRA DI SIENA



RUGIADA TERRA DI SIENA



TRAMA TERRA DI SIENA

44



FONDO TERRA DI SIENA 20x20



FONDO TERRA DI SIENA 5x20

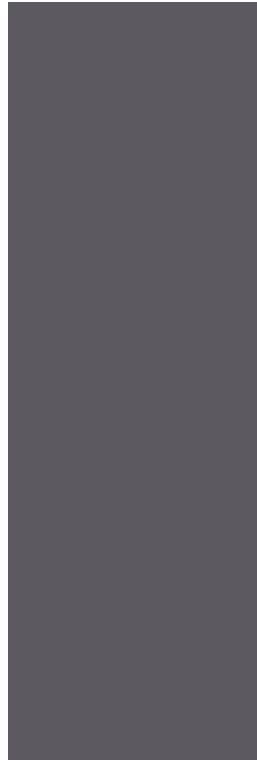

FONDO DORIAN 20x60

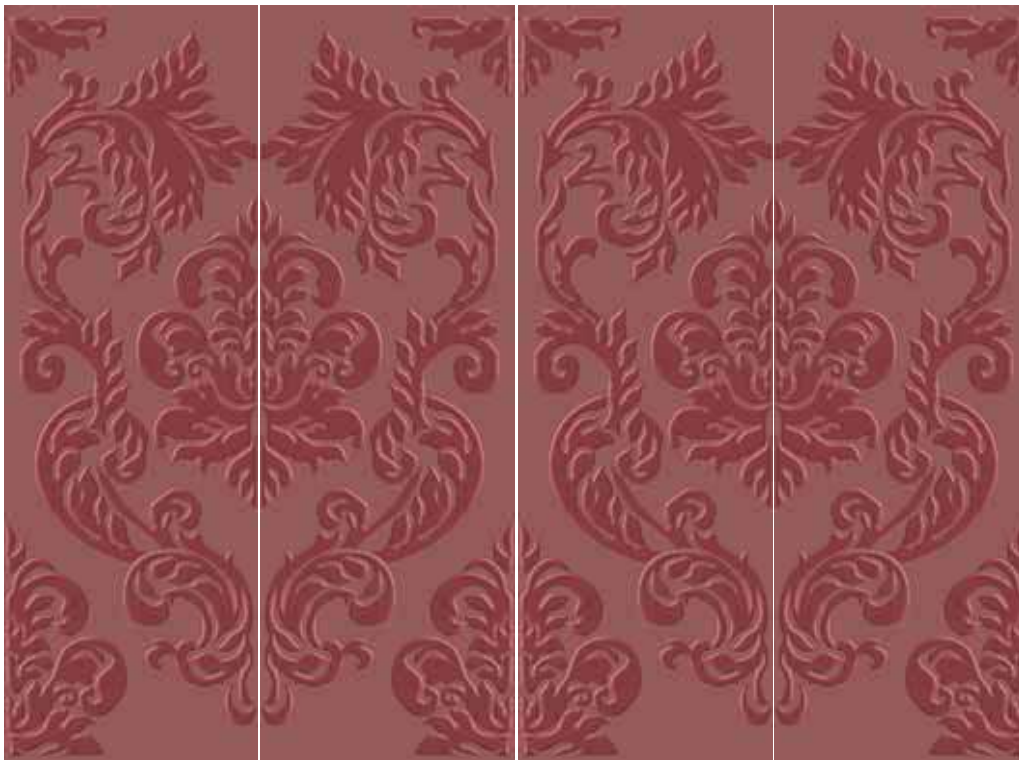

GRANDE BAROCCO TERRA DI SIENA 20x60





45

CACAO 20x20

46



FONDO CACAO



GERMOGLIO CACAO



RUGIADA CACAO



RICCIOLI CACAO

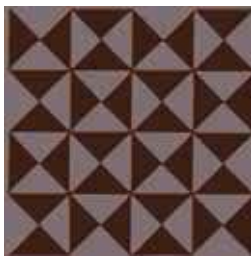

TRIANGOLI CACAO



RIGHE CACAO



GEOMETRIE CACAO



RICAMO CACAO



BOCCILO CACAO



FILIGRANA CACAO



CACAO 20x60



FONDO CACAO



ARABESCO CACAO



GRANDE BAROCCO CACAO



DAMASCATO CACAO



PARTENOPE CACAO



RUGIADA CACAO



TRAMA CACAO

48



FONDO CACAO 20x20



GEOMETRIE CACAO 20X20

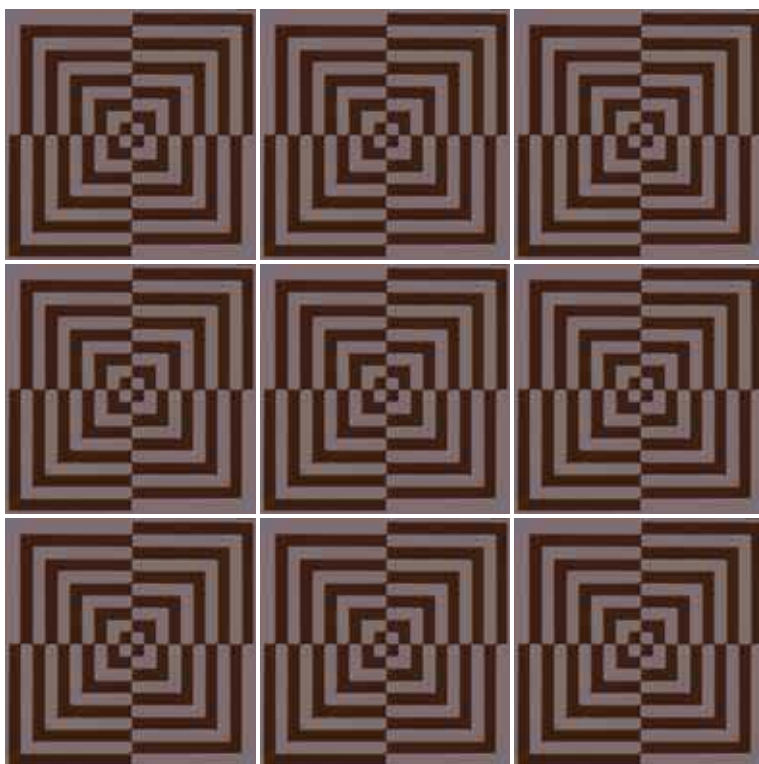



49

CUOIO 20x20

50



FONDO CUOIO



GERMOGLIO CUOIO



RUGIADA CUOIO



RICCIOLI CUOIO



TRIANGOLI CUOIO



RIGHE CUOIO

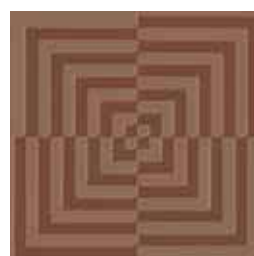

GEOMETRIE CUOIO



RICAMO CUOIO



BOCCILO CUOIO



FILIGRANA CUOIO

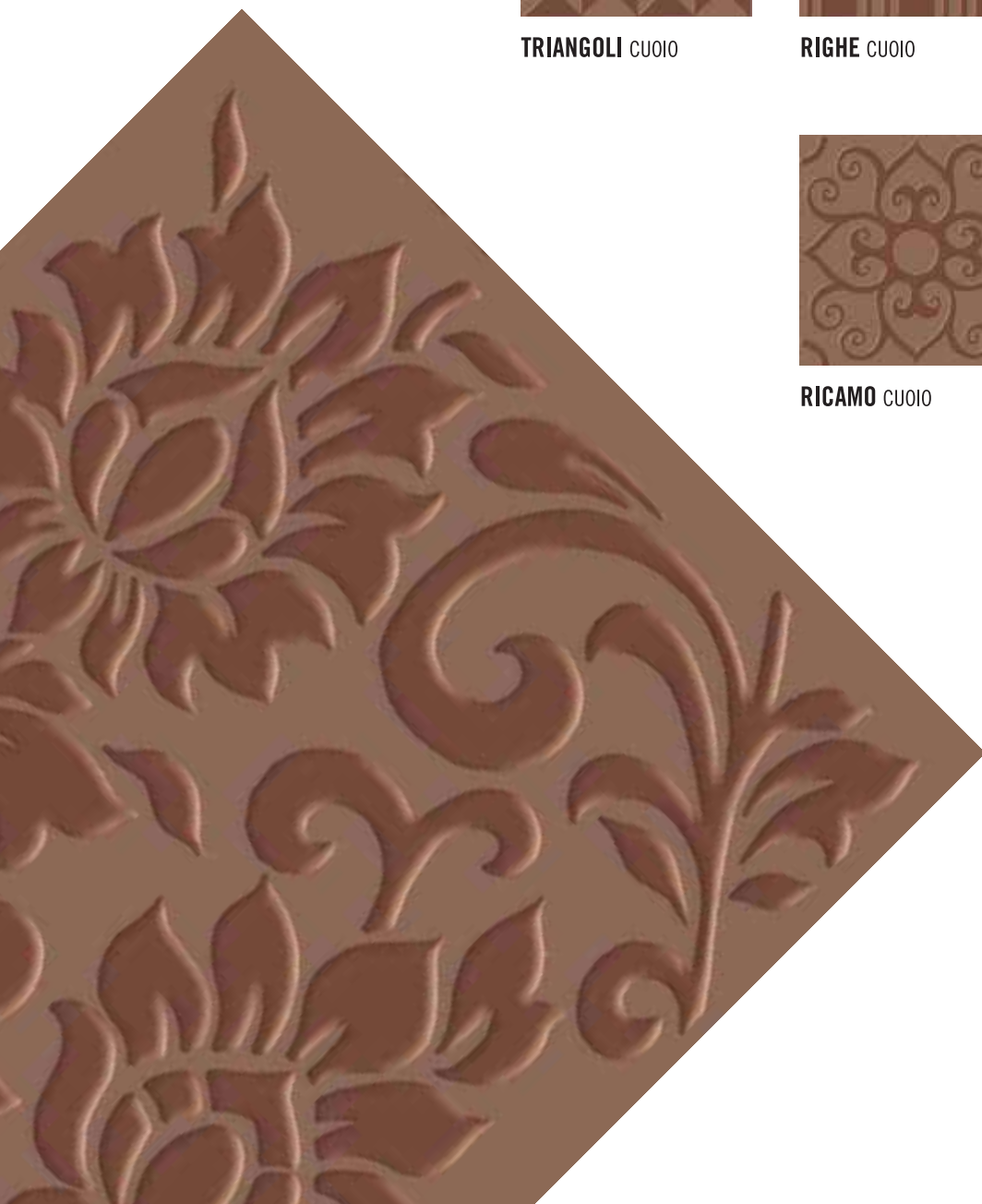

CUOIO 20x60



FONDO CUOIO



ARABESCO CUOIO



GRANDE BAROCCO CUOIO



DAMASCATO CUOIO



PARTENOPE CUOIO



RUGIADA CUOIO



TRAMA CUOIO

52



GERMOGLIO CUOIO 20x20

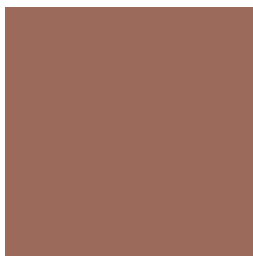

FONDO CUOIO 20x20





53

AMARENA 20x20

54



FONDO AMARENA



GERMOGLIO AMARENA



RUGIADA AMARENA



RICCIOLI AMARENA



TRIANGOLI AMARENA



RIGHE AMARENA

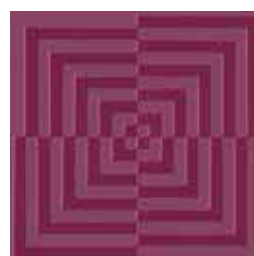

GEOMETRIE AMARENA



RICAMO AMARENA



BOCCILO AMARENA



FILIGRANA AMARENA



AMARENA 20x60

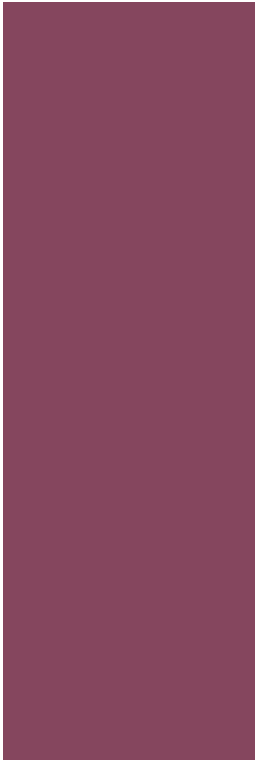

FONDO AMARENA



ARABESCO AMARENA



GRANDE BAROCCO AMARENA



DAMASCATO AMARENA



PARTENOPE AMARENA



RUGIADA AMARENA



TRAMA AMARENA

PRUGNA 20x20

56



FONDO PRUGNA



GERMOGLIO PRUGNA



RUGIADA PRUGNA



RICCIOLI PRUGNA



TRIANGOLI PRUGNA



RIGHE PRUGNA

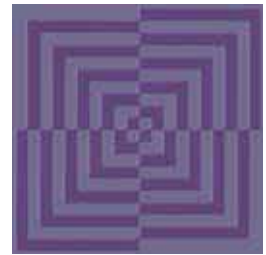

GEOMETRIE PRUGNA



RICAMO PRUGNA



BOCCIOLIO PRUGNA



FILIGRANA PRUGNA

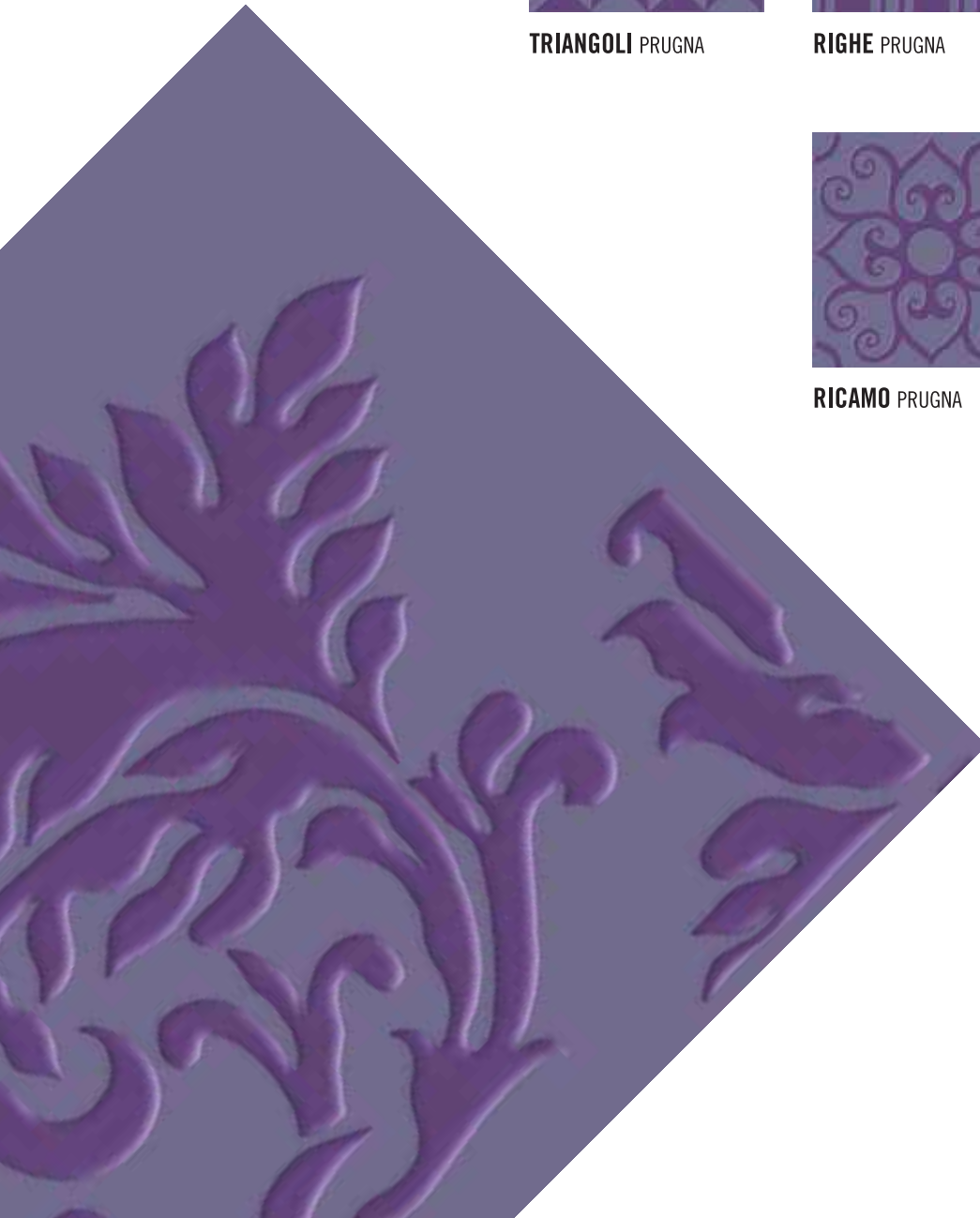

PRUGNA 20x60



FONDO PRUGNA



ARABESCO PRUGNA



GRANDE BAROCCO PRUGNA



DAMASCATO PRUGNA



PARTENOPE PRUGNA



RUGIADA PRUGNA



TRAMA PRUGNA

58



FONDO PRUGNA 20X20



FONDO PRUGNA 20X60



ARABESCO MELANZANA 20X60





59

MELANZANA 20x20

60

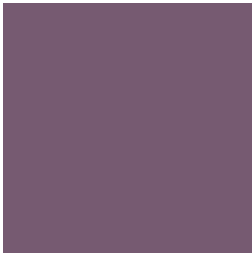

FONDO MELANZANA



GERMOGLIO MELANZANA



RUGIADA MELANZANA



RICCIOLI MELANZANA



TRIANGOLI MELANZANA



RIGHE MELANZANA

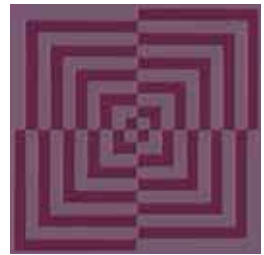

GEOMETRIE MELANZANA



RICAMO MELANZANA



BOCCILO MELANZANA



FILIGRANA MELANZANA

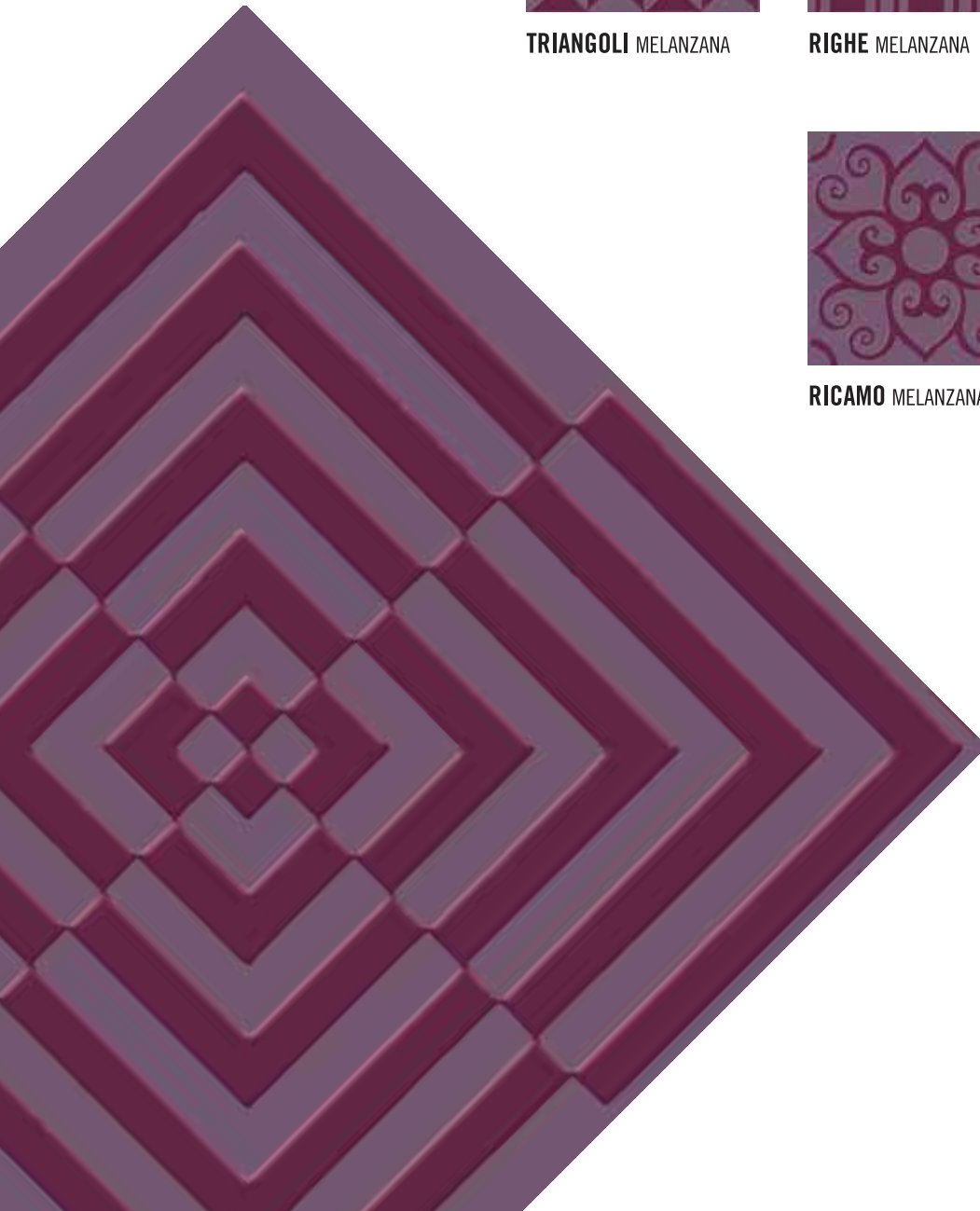

MELANZANA 20x60



FONDO MELANZANA



ARABESCO MELANZANA



GRANDE BAROCCO MELANZANA



DAMASCATO MELANZANA



PARTENOPE MELANZANA



RUGIADA MELANZANA



TRAMA MELANZANA

CIELO 20x20

62



FONDO CIELO



GERMOGLIO CIELO



RUGIADA CIELO



RICCIOLI CIELO



TRIANGOLI CIELO



RIGHE CIELO

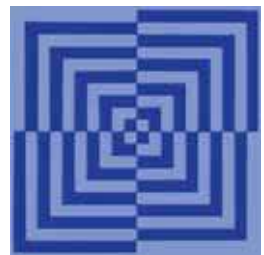

GEOMETRIE CIELO



RICAMO CIELO



BOCCILOLO CIELO



FILIGRANA CIELO



CIELO 20x60



FONDO CIELO



ARABESCO CIELO



GRANDE BAROCCO CIELO



DAMASCATO CIELO



PARTENOPE CIELO



RUGIADA CIELO



TRAMA CIELO

64



RICCIOLI CIELO 20x20



FONDO COBALTO 20x20



FONDO CIELO 20x20



FONDO COBALTO 20x60

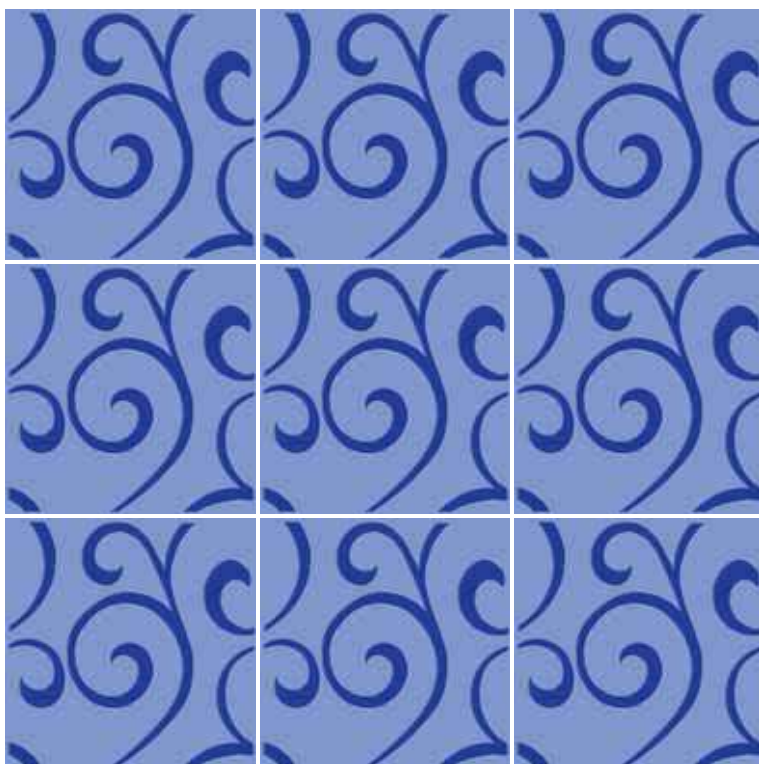



65

AVION 20x20

66



FONDO AVION



GERMOGLIO AVION



RUGIADA AVION



RICCIOLI AVION



TRIANGOLI AVION



RIGHE AVION

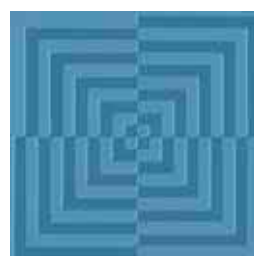

GEOMETRIE AVION



RICAMO AVION



BOCCILO AVION



FILIGRANA AVION

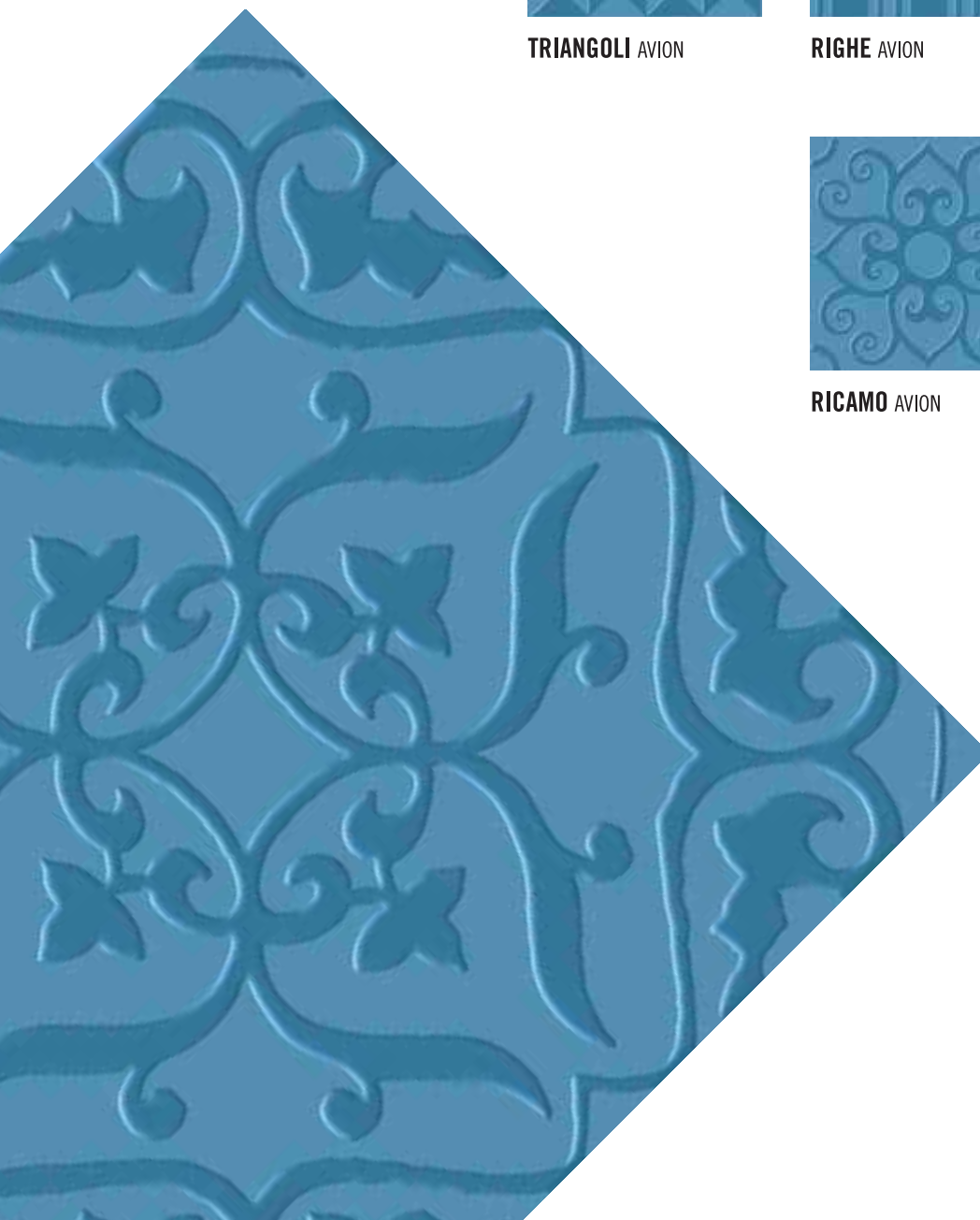

AVION 20x60

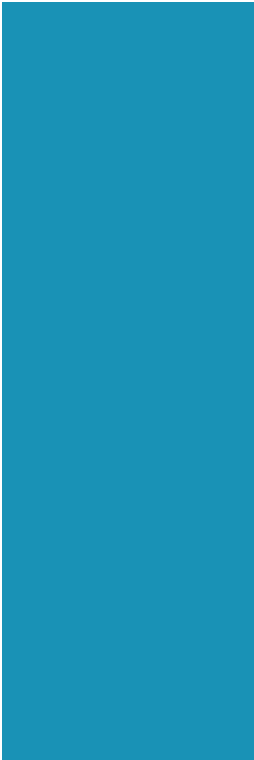

FONDO AVION



ARABESCO AVION



GRANDE BAROCCO AVION



DAMASCATO AVION



PARTENOPE AVION



RUGIADA AVION



TRAMA AVION

68



RUGIADA AVION 20x20



FONDO AVION 10x10

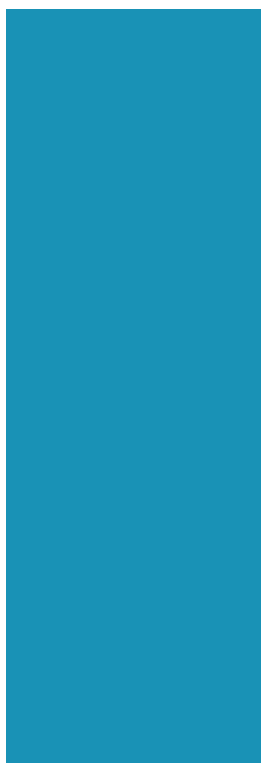

FONDO AVION 20x60

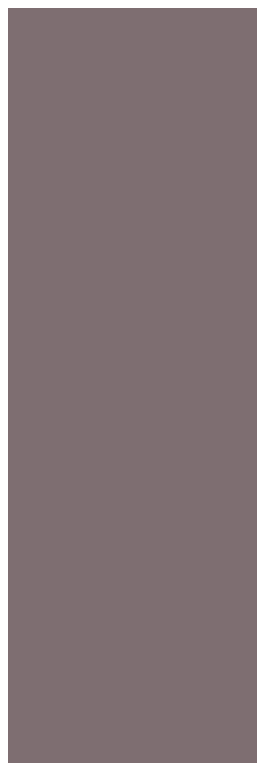

FONDO CACAO 20x60

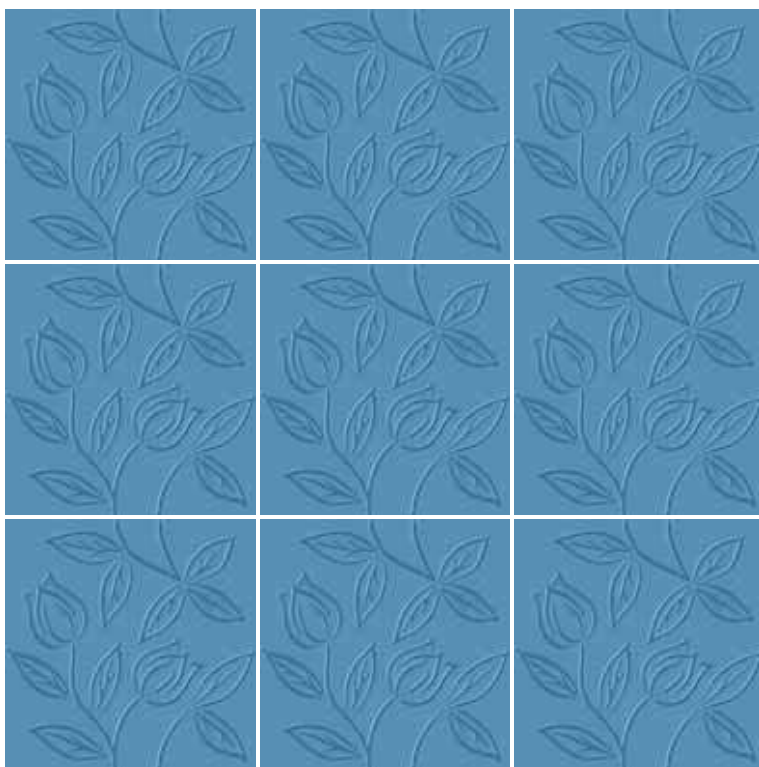



COBALTO 20x20

70



FONDO COBALTO



GERMOGLIO COBALTO



RUGIADA COBALTO



RICCIOLI COBALTO

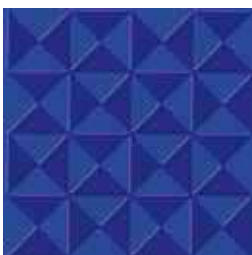

TRIANGOLI COBALTO



RIGHE COBALTO

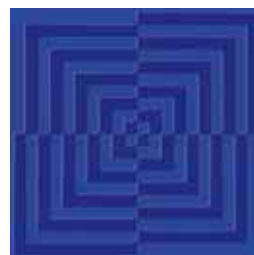

GEOMETRIE COBALTO



RICAMO COBALTO



BOCCILO COBALTO



FILIGRANA COBALTO

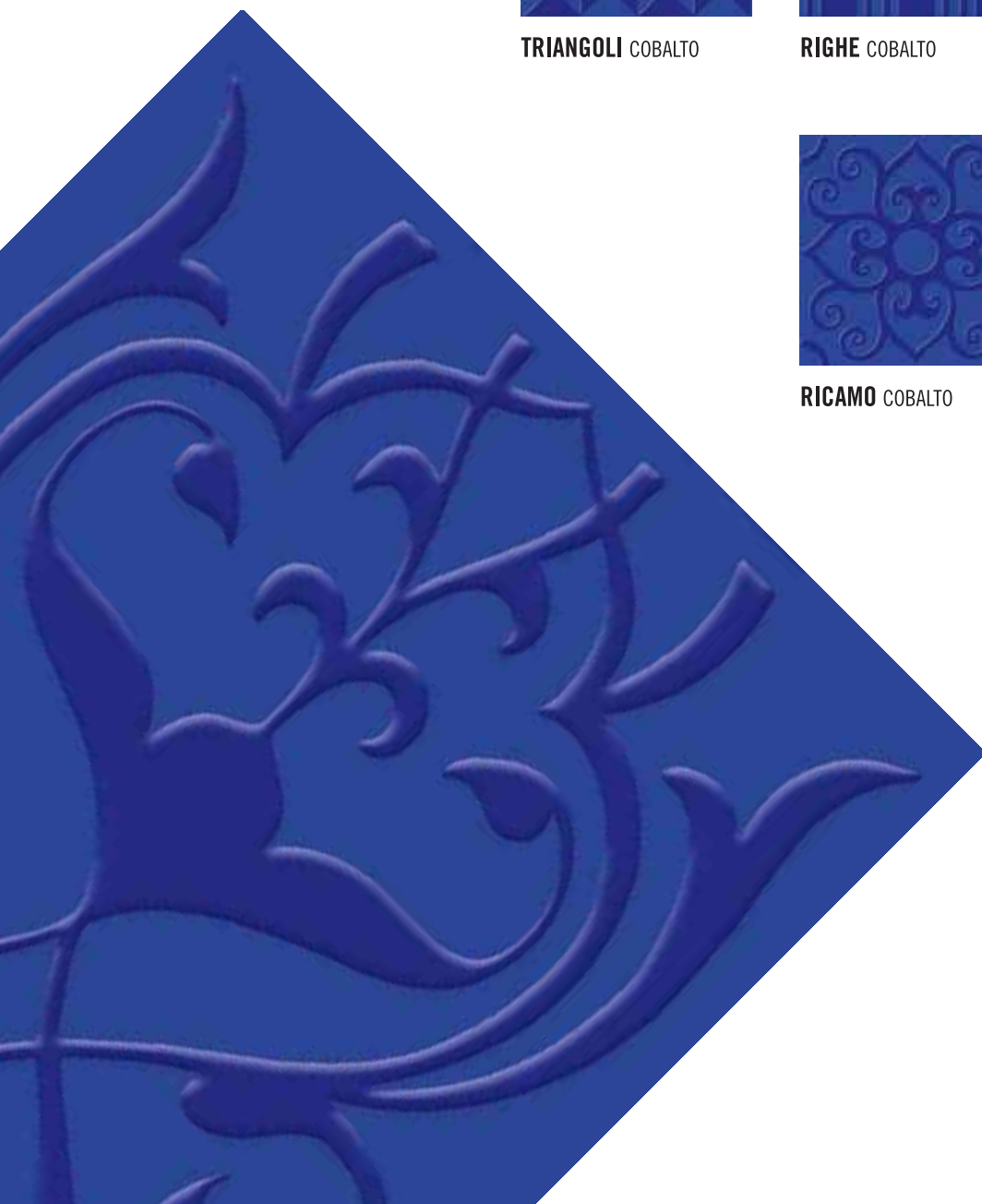

COBALTO 20x60



FONDO COBALTO



ARABESCO COBALTO



GRANDE BAROCCO COBALTO



DAMASCATO COBALTO



PARTENOPE COBALTO



RUGIADA COBALTO



TRAMA COBALTO

72

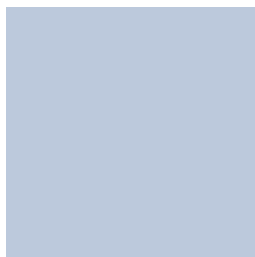

FONDO CENERE 20x20



RIGHE COBALTO 20x20

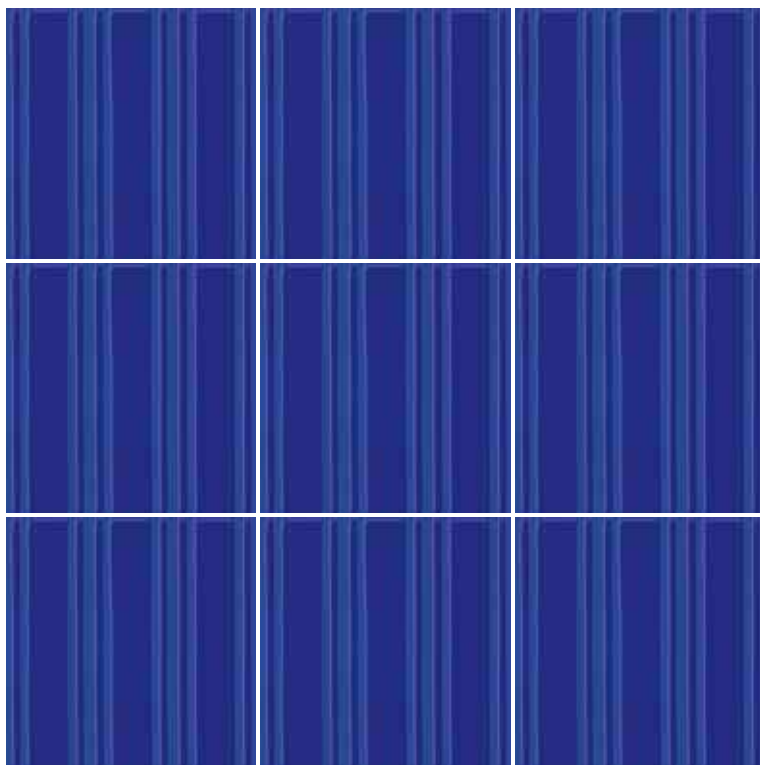



73

74



FILIGRANA PRATO 20x20



FONDO DORIAN 20x20



FONDO ONICE 10x30

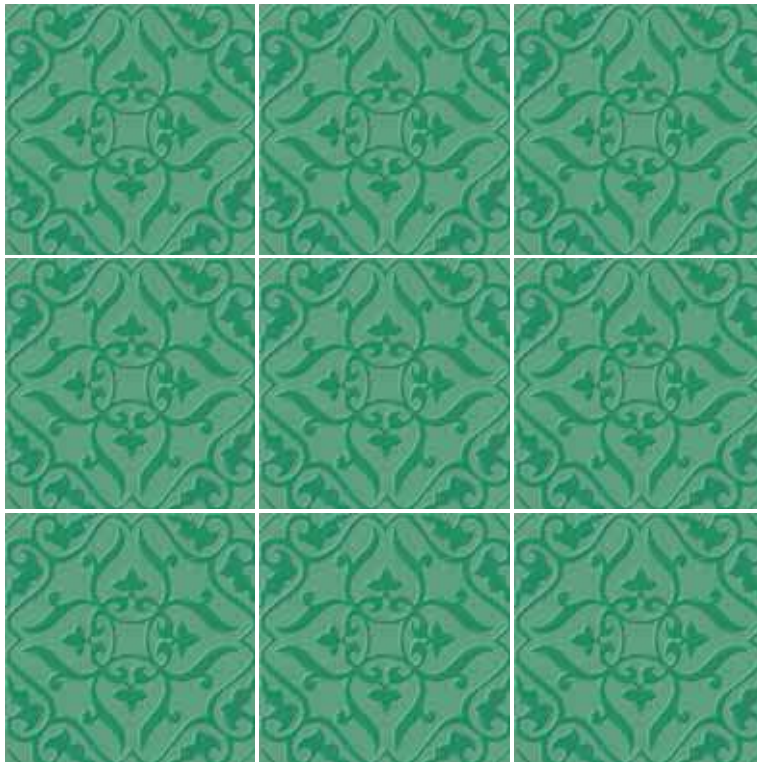



75

76



FONDO ACQUA



GERMOGLIO ACQUA



RUGIADA ACQUA



RICCIOLI ACQUA



TRIANGOLI ACQUA

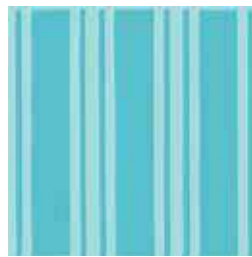

RIGHE ACQUA

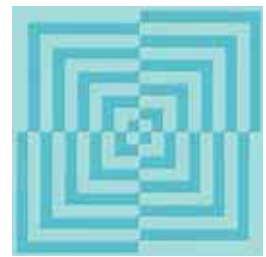

GEOMETRIE ACQUA



RICAMO ACQUA



BOCCILO ACQUA



FILIGRANA ACQUA

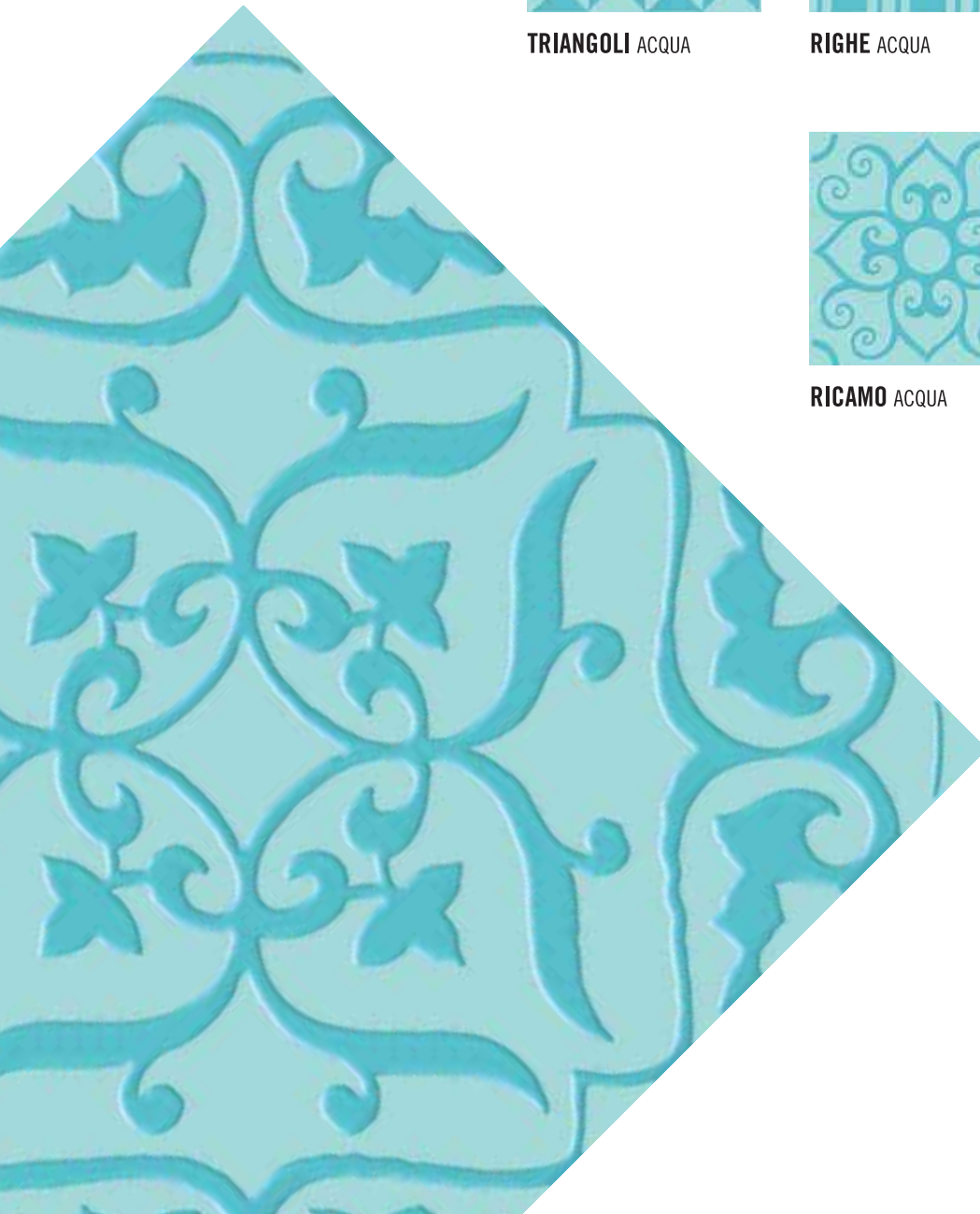

ACQUA 20x60

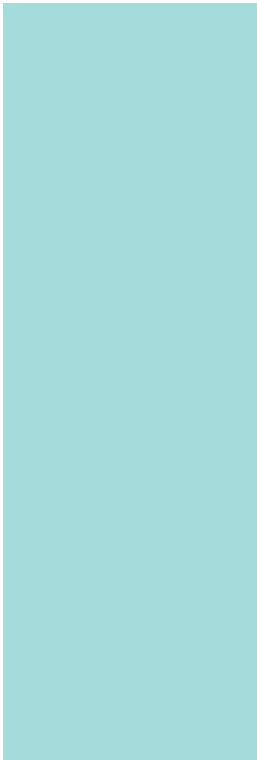

FONDO ACQUA



ARABESCO ACQUA



GRANDE BAROCCO ACQUA



DAMASCATO ACQUA



PARTENOPE ACQUA



RUGIADA ACQUA



TRAMA ACQUA

PRATO 20x20

78



FONDO PRATO



GERMOGLIO PRATO



RUGIADA PRATO



RICCIOLI PRATO



TRIANGOLI PRATO

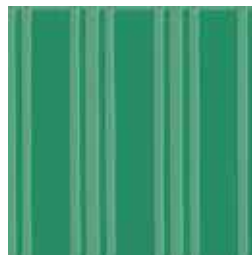

RIGHE PRATO

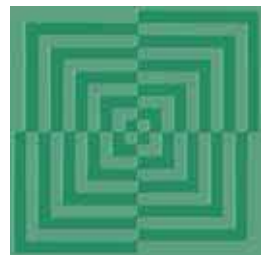

GEOMETRIE PRATO



RICAMO PRATO



BOCCIOLIO PRATO



FILIGRANA PRATO



PRATO 20x60

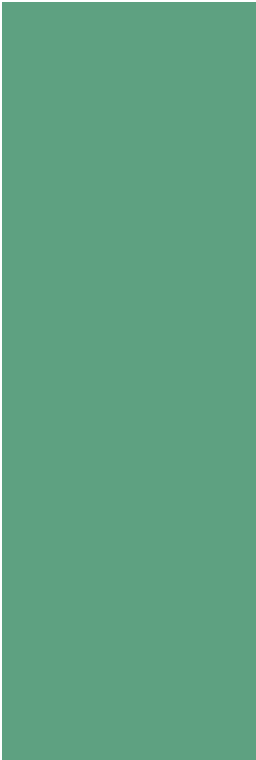

FONDO PRATO



ARABESCO PRATO



GRANDE BAROCCO PRATO



DAMASCATO PRATO



PARTENOPE PRATO



RUGIADA PRATO



TRAMA PRATO

80



RICAMO PRATO 20x20

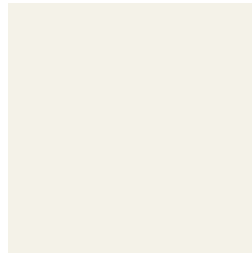

FONDO GHIACCIO 20x20



FONDO PRATO 20x60

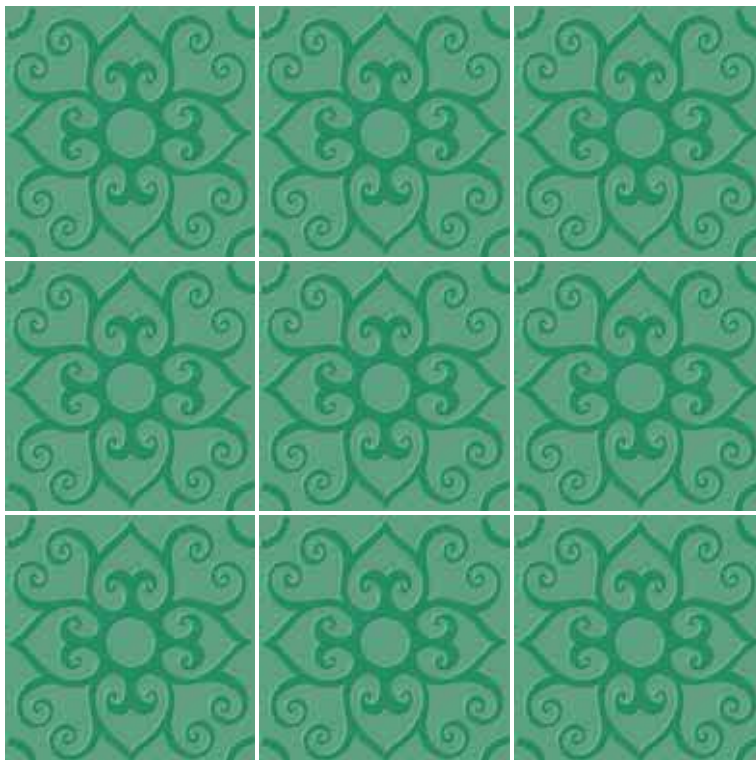



81

GHIACCIO 20x20

82

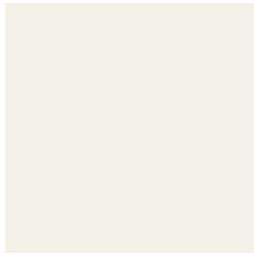

FONDO GHIACCIO



GERMOGLIO GHIACCIO

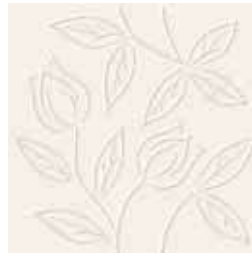

RUGIADA GHIACCIO



RICCIOLI GHIACCIO



TRIANGOLI GHIACCIO



RIGHE GHIACCIO



GEOMETRIE GHIACCIO

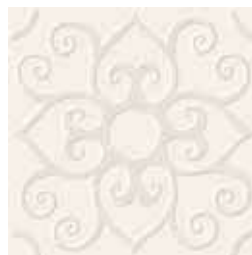

RICAMO GHIACCIO

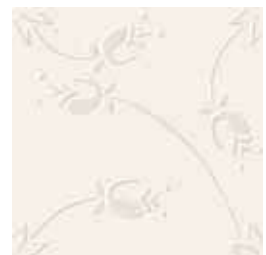

BOCCILOLO GHIACCIO

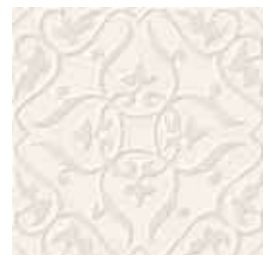

FILIGRANA GHIACCIO



GHIACCIO 20x60

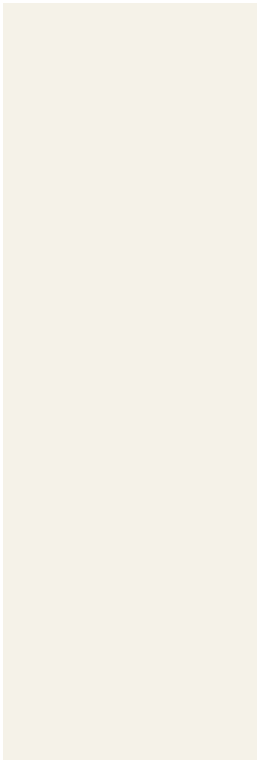

FONDO GHIACCIO



ARABESCO GHIACCIO



GRANDE BAROCCO GHIACCIO



DAMASCATO GHIACCIO



PARTENOPE GHIACCIO



RUGIADA GHIACCIO



TRAMA GHIACCIO

84



TRIANGOLI GHIACCIO 20x20

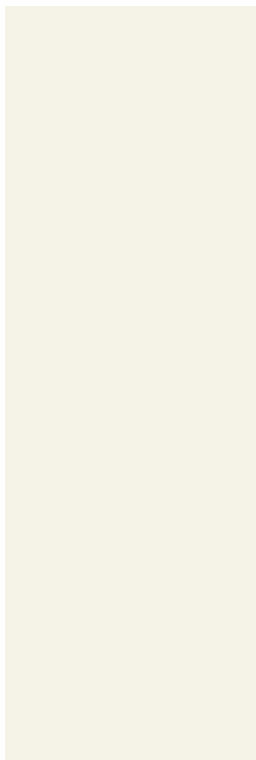

FONDO GHIACCIO 20x60

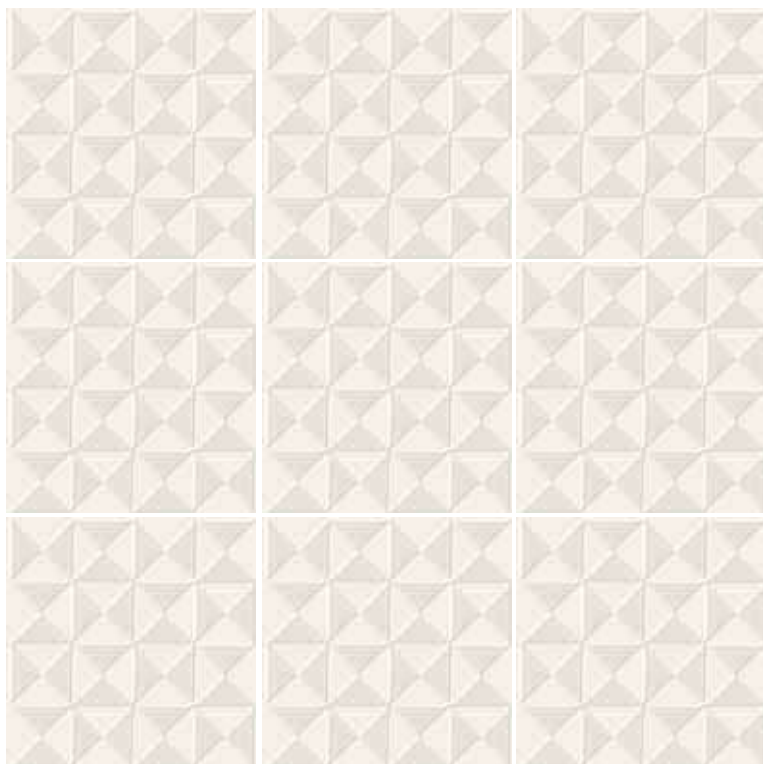



85

PANNA 20x20

86

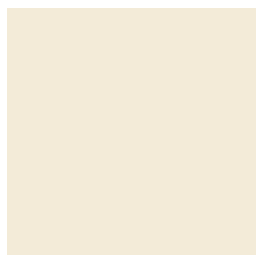

FONDO PANNA

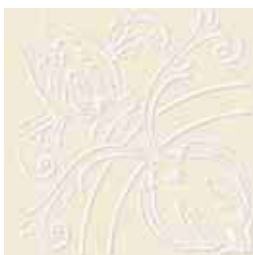

GERMOGLIO PANNA



RUGIADA PANNA



RICCIOLI PANNA



TRIANGOLI PANNA



RIGHE PANNA



GEOMETRIE PANNA



RICAMO PANNA



BOCCILO PANNA

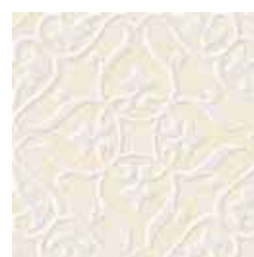

FILIGRANA PANNA



PANNA 20x60

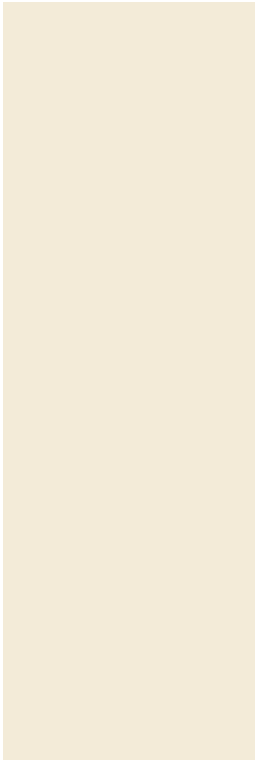

FONDO PANNA



ARABESCO PANNA



GRANDE BAROCCO PANNA



DAMASCATO PANNA



PARTENOPE PANNA



RUGIADA PANNA



TRAMA PANNA

SABBIA 20x20

88



FONDO SABBIA



GERMOGLIO SABBIA



RUGIADA SABBIA



RICCIOLI SABBIA



TRIANGOLI SABBIA



RIGHE SABBIA



GEOMETRIE SABBIA



RICAMO SABBIA



BOCCIOLIO SABBIA



FILIGRANA SABBIA

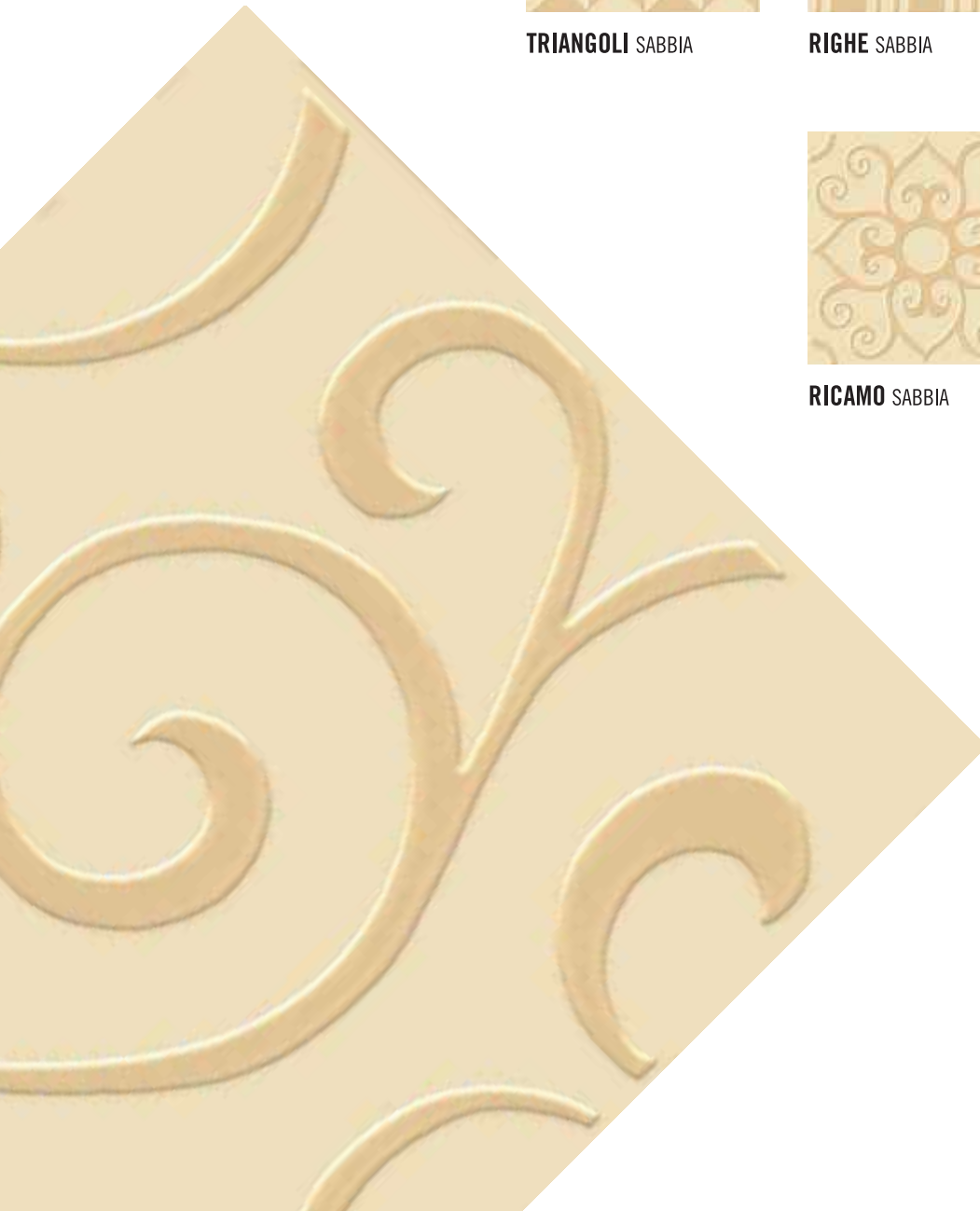

SABBIA 20x60

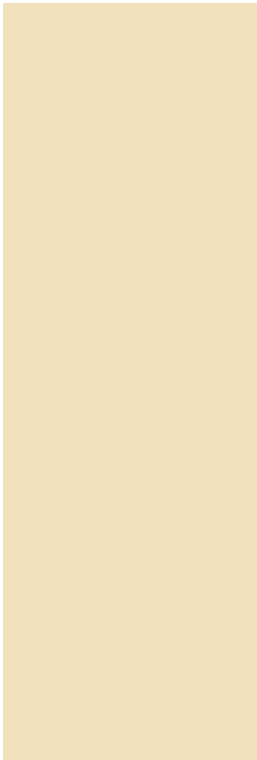

FONDO SABBIA



ARABESCO SABBIA



GRANDE BAROCCO SABBIA



DAMASCATO SABBIA



PARTENOPE SABBIA



RUGIADA SABBIA



TRAMA SABBIA

90

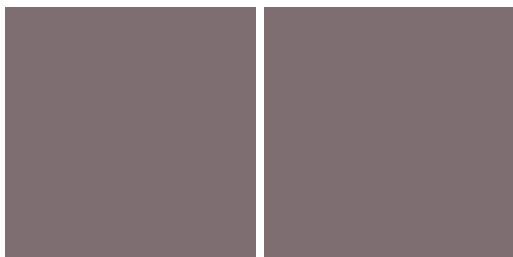

FONDO CACAO 20x20

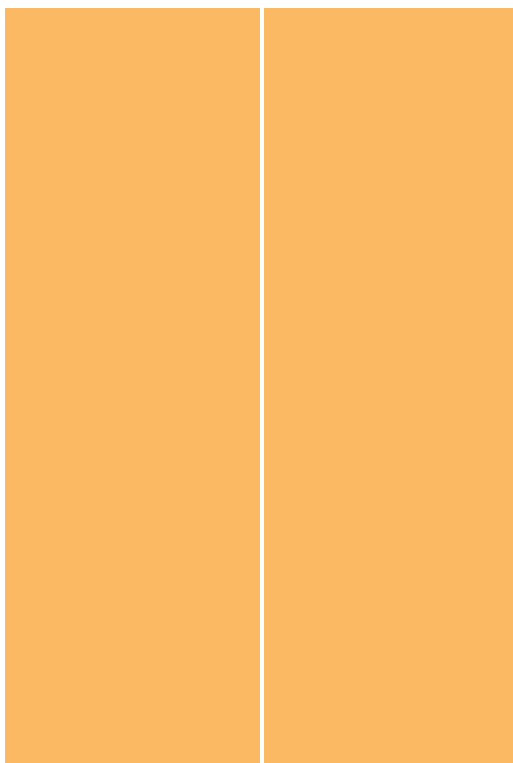

FONDO OCRA 20x60



TRAMA OCRA 20x60





91

92



FONDO OCRA



GERMOGLIO OCRA



RUGIADA OCRA



RICCIOLI OCRA



TRIANGOLI OCRA



RIGHE OCRA

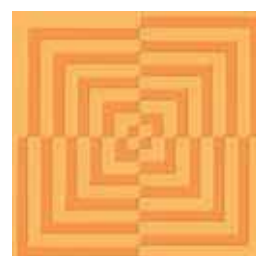

GEOMETRIE OCRA



RICAMO OCRA



BOCCILO OCRA



FILIGRANA OCRA



OCRA 20x60



FONDO OCRA



ARABESCO OCRA



GRANDE BAROCCO OCRA



DAMASCATO OCRA



PARTENOPE OCRA



RUGIADA OCRA



TRAMA OCRA

MANDARINO 20x20

94



FONDO MANDARINO



GERMOGLIO MANDARINO



RUGIADA MANDARINO



RICCIOLI MANDARINO



TRIANGOLI MANDARINO



RIGHE MANDARINO

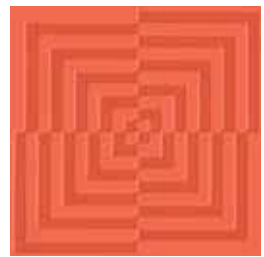

GEOMETRIE MANDARINO



RICAMO MANDARINO



BOCCILO MANDARINO



FILIGRANA MANDARINO



MANDARINO 20x60



FONDO MANDARINO



ARABESCO MANDARINO



GRANDE BAROCCO MANDARINO



DAMASCATO MANDARINO



PARTENOPE MANDARINO



RUGIADA MANDARINO



TRAMA MANDARINO

96



FONDO OCRA 20x20



FONDO OCRA 5x20



DAMASCATO
MANDARINO 20X60

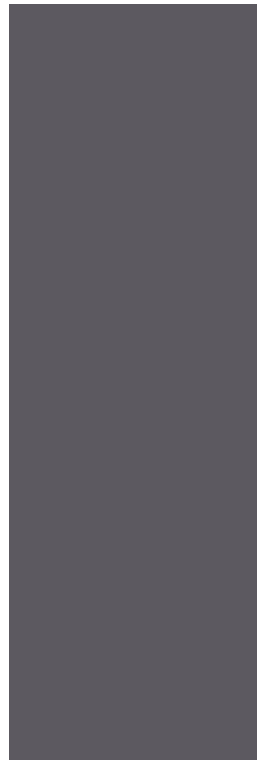

FONDO DORIAN 20X60

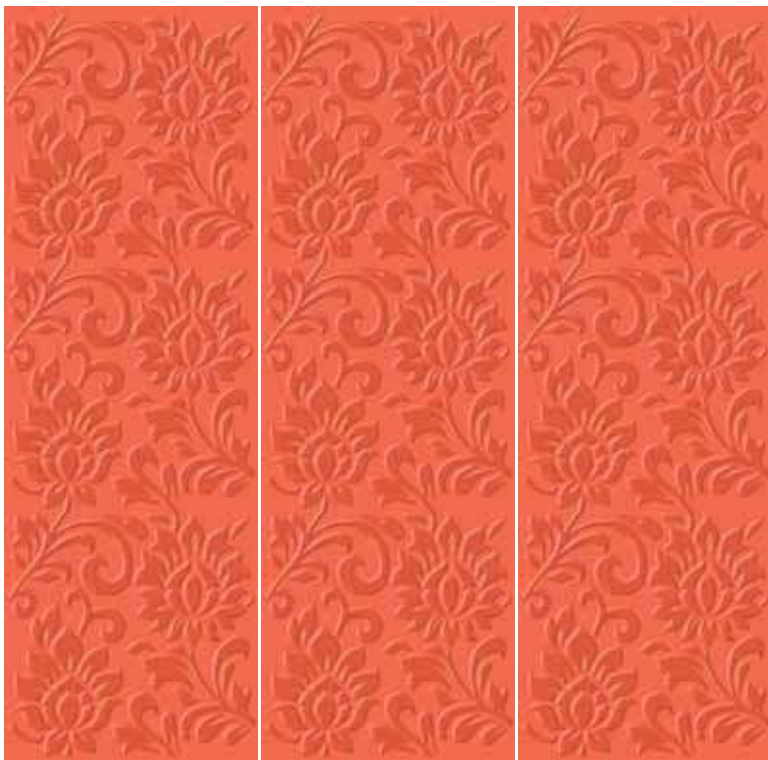



CORALLO 20x20

98



FONDO CORALLO



GERMOGLIO CORALLO



RUGIADA CORALLO



RICCIOLI CORALLO



TRIANGOLI CORALLO



RIGHE CORALLO

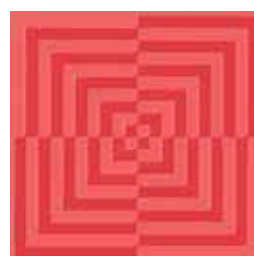

GEOMETRIE CORALLO



RICAMO CORALLO



BOCCIOLIO CORALLO

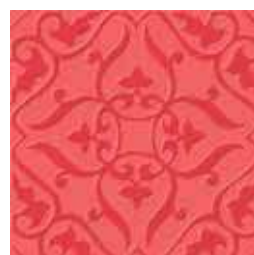

FILIGRANA CORALLO

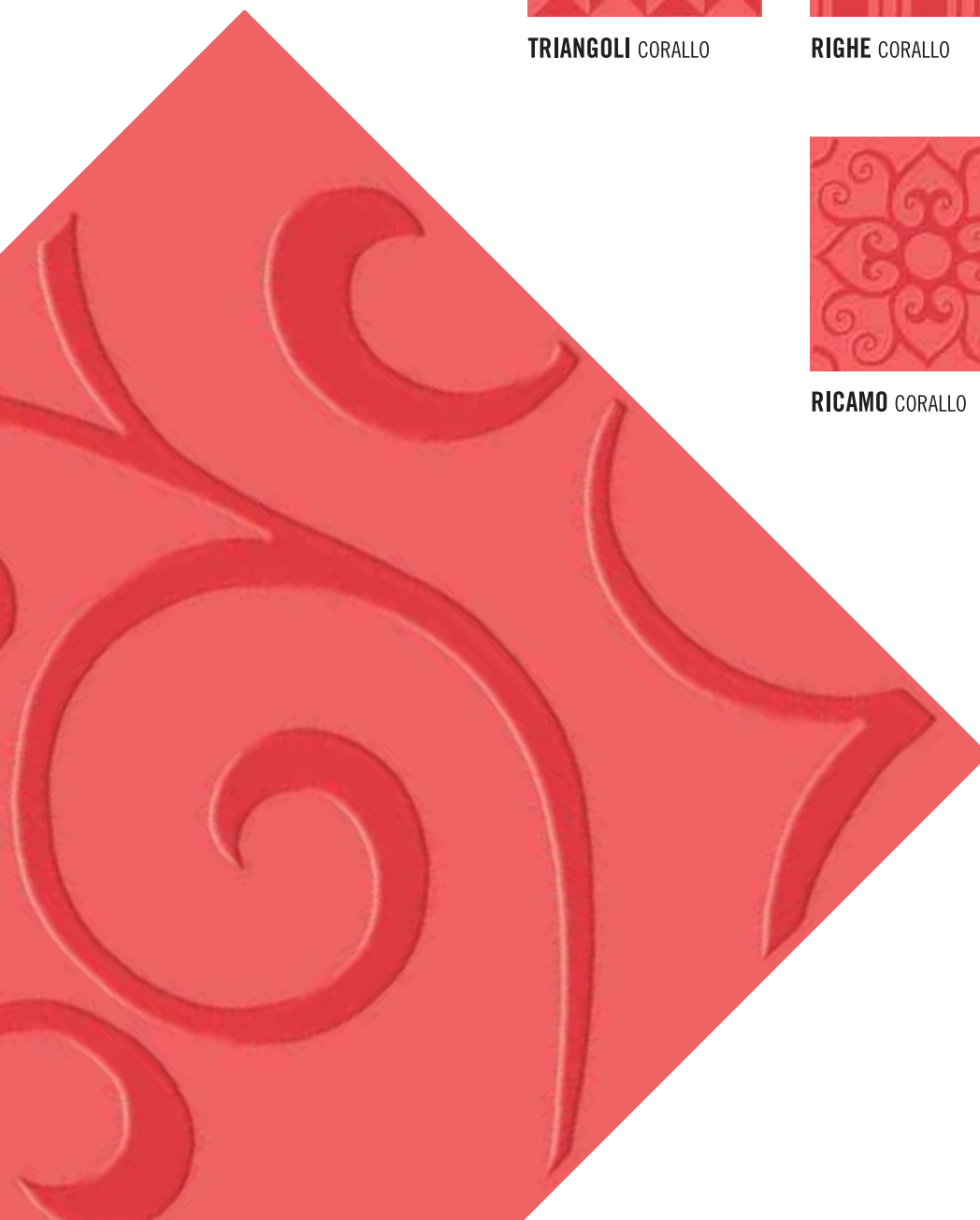

CORALLO 20x60



FONDO CORALLO



ARABESCO CORALLO



GRANDE BAROCCO CORALLO



DAMASCATO CORALLO



PARTENOPE CORALLO



RUGIADA CORALLO



TRAMA CORALLO

FORMATI E PEZZI SPECIALI

Tutti i formati hanno uno spessore di 10 mm

100



>

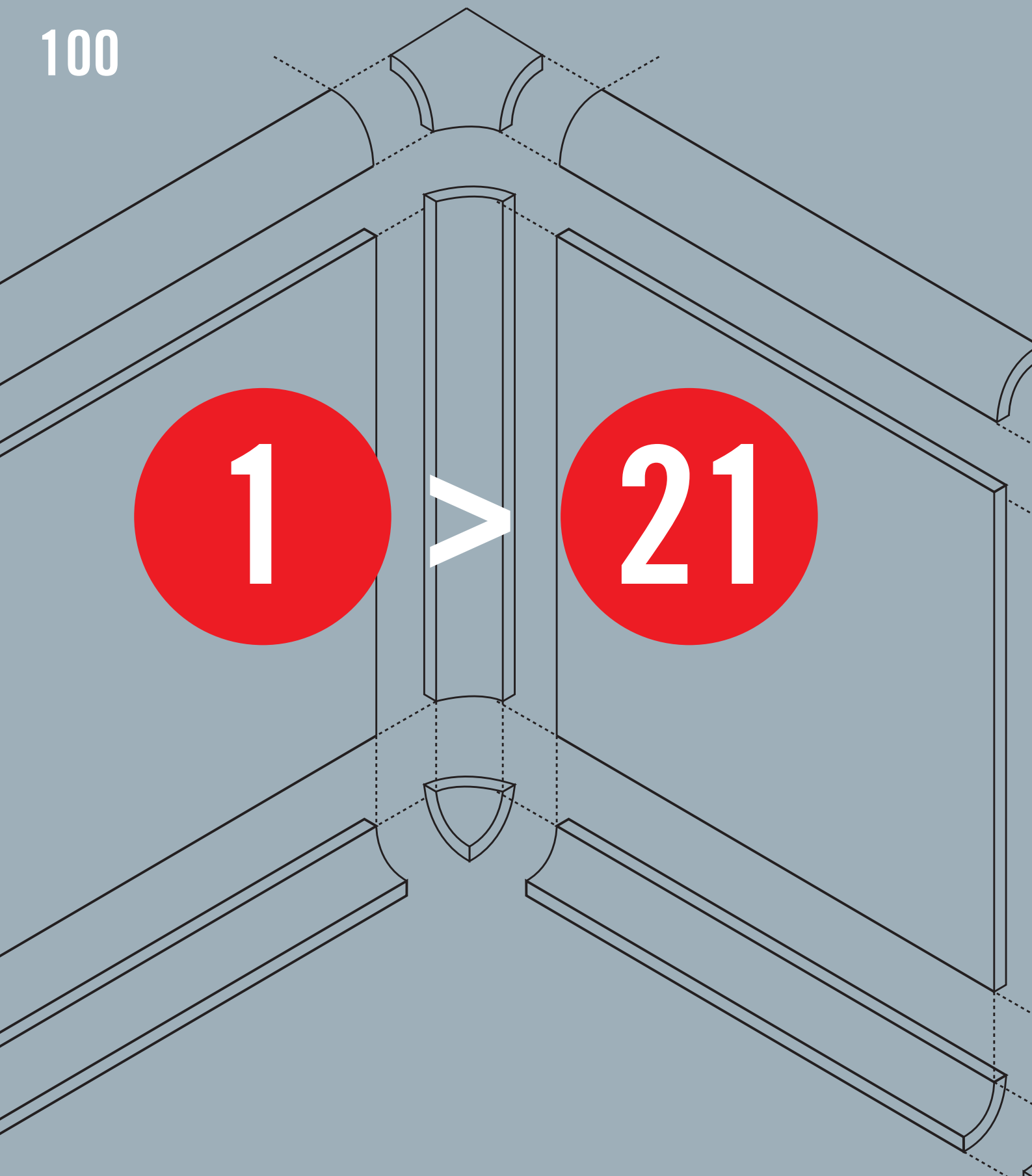

QUADRATI



30x30 cm

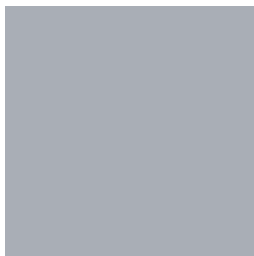

20x20 cm



10x10 cm



5x5 cm

RETTANGOLI



20x60 cm



10x30 cm



10x20 cm



5x20 cm



3x20 cm

101

DECORI



20x20 cm



20x60 cm

FORMATI E PEZZI SPECIALI

Tutti i formati hanno uno spessore di 10 mm

102

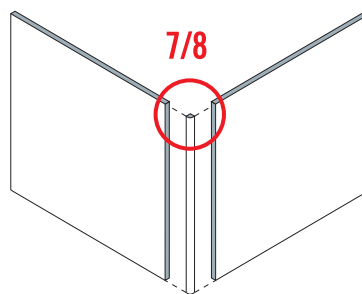
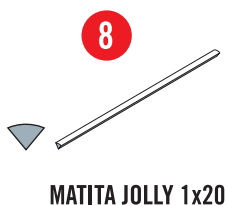
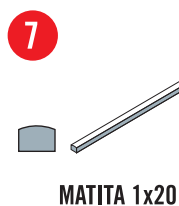
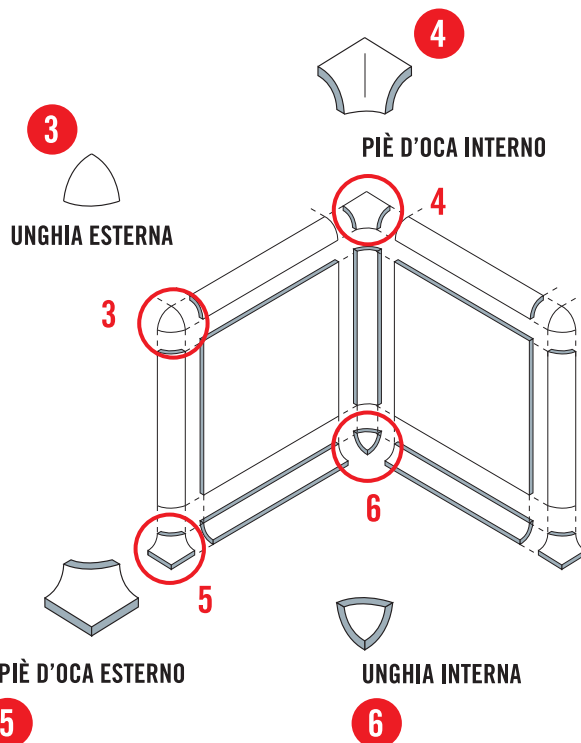
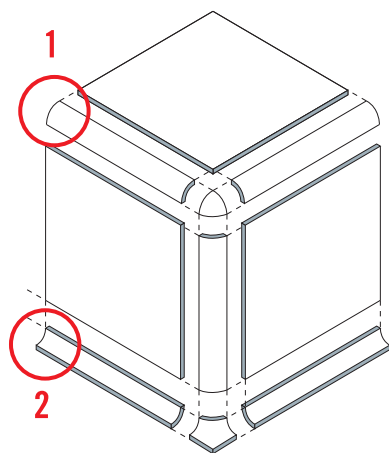
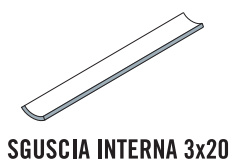

9
LISTELLI
BECCO DI CIVETTA

10
8x20 BECCO DI CIVETTA

3x20 BECCO DI CIVETTA

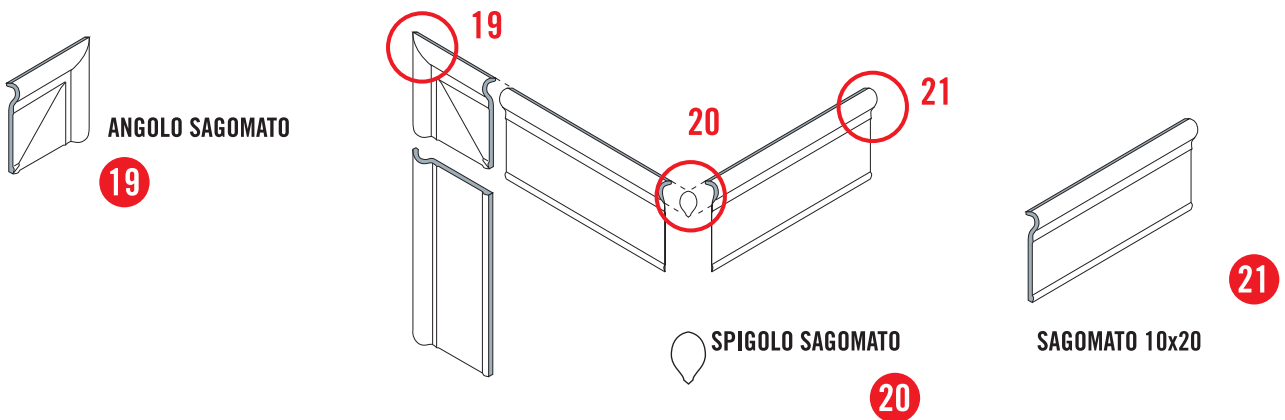
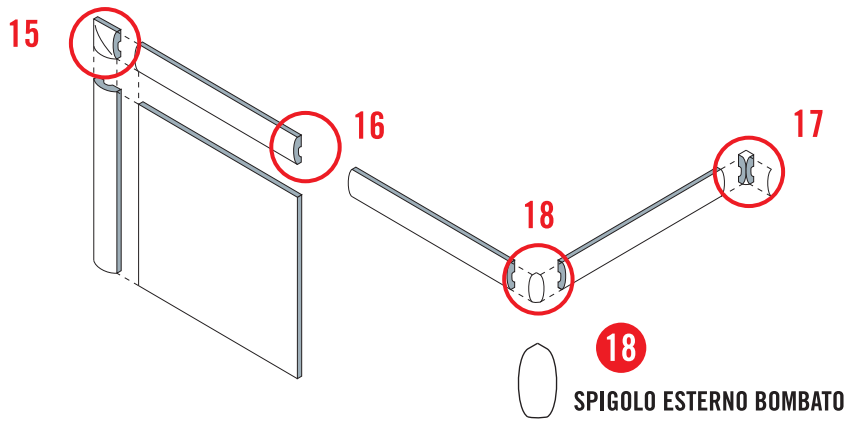
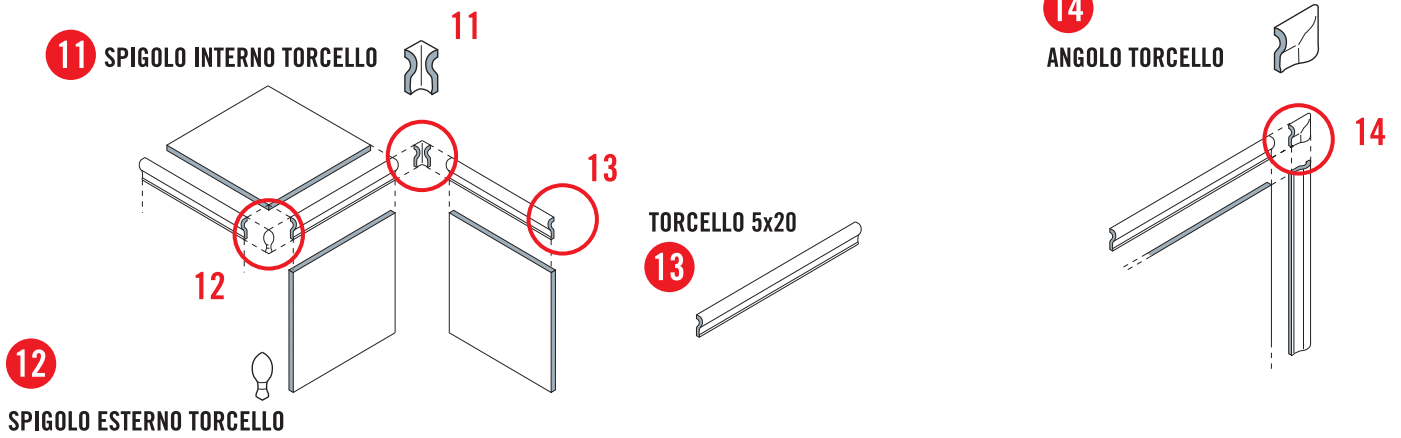

ICHIAROSCURI DI GIOVANNI DE MAIO

Ricerca e sviluppo:	GIOVANNI DE MAIO
Marketing e promozione:	ANTONIO DE MAIO MARCO DE MAIO DOMENICO DE MAIO
Produzione:	ELIO DE MAIO
Amministrazione e gestione:	GINO CUOCO PATRIZIA TROIANO MONICA DE MAIO
Customer service:	DANIELA BARBARA
Grafica:	RENATO MAFFEI (Tiresia Comunicazione srl)
Prestampa:	CLAUDIO CANONICO (Spaziotif)
Consulenza:	FRANCESCO MARINELLI (3D) RAFFAELE RAGO (Testi)
Coordinamento di produzione:	TIRESIA COMUNICAZIONE + SPAZIOTIF
Stampa:	GRAFICANAPPA

GIOVANNI DE MAIO s.r.l.

VIA CERVITO, 51 (84084) FISCIANO (SALERNO) ITALIA

TEL. +39.089.826169

FAX +39.089.879408

info@giovanidemaio.com

www.giovanidemaio.com

settembre 2013



GIOVANNI DE MAIO s.r.l.

VIA CERVITO, 51 (84084) FISCIANO (SALERNO) ITALIA

TEL. +39.089.826169 - FAX +39.089.879408

info@giovanidemaio.com - www.giovanidemaio.com

